

DIGITAL 20 WORKING 24



Worktitude
For Light

Soluciones
Lumínicas

Información
Técnica



WORKTITUDE FOR LIGHT

1.

WORKTITUDE FOR LIGHT

- Highlights

WORKING PATHS

- Worktitude for Wellbeing

- Worktitude for Life

- Worktitude for Innovation

2.

SEGMENTS

3.

SERVICES LAMP+

4.

CIRCULIGHT

Worktitude For Light

En Lamp somos *trabajo y actitud,*
somos *Worktitude for Light.*



Asesoramos, diseñamos, producimos, comercializamos y ponemos en marcha proyectos de iluminación técnica. Es el sello Lamp, un compromiso que mantenemos desde hace más de 50 años: convertir en realidad los retos lumínicos de nuestros clientes con una respuesta solvente y a medida en cualquier proyecto arquitectónico del mundo.

Working for light that works

La luz es nuestro ADN

Haciendo realidad los **retos lumínicos de nuestros clientes desde hace 50 años**. Unimos **experiencia, conocimiento y una constante evolución**, desde nuestro proceso de fabricación hasta nuestros servicios de asesoría.

Equipo humano

Ingenieros, diseñadores, técnicos y un sinfín de **perfiles profesionales trabajan unidos** en tu próximo proyecto.

Visión internacional, compromiso local

Desde **nuestra fábrica y HQ en Terrassa**, junto con la presencia local a través de nuestras **8 filiales**, llegamos a **más de 70 países**.

Co-Creation

Formando un solo equipo con nuestros clientes, para desarrollar **soluciones lumínicas especiales haciendo que cada proyecto sea único**.

La luz es nuestro ADN

Desde hace 50 años **convertimos en realidad los retos lumínicos de nuestros clientes.** Unimos **experiencia, conocimiento y una constante evolución,** desde nuestro proceso de fabricación hasta nuestro servicios de asesoría.

Incorporamos a nuestras soluciones de iluminación los últimos avances tecnológicos, siempre buscando el compromiso con la calidad de luz que cada proyecto necesita.

Apoyamos y defendemos la buena iluminación. Y por ello creamos los Premios Lamp, para premiar la creatividad, la innovación y la sustentabilidad de los proyectos lumínicos.

Visión internacional, compromiso local

Tenemos una visión internacional, lo que nos permite ofrecer soluciones de iluminación que aborden proyectos de manera global **manteniendo el compromiso con el mercado local** gracias a la presencia de nuestros equipos en las diferentes filiales y oficinas comerciales.

Pensamos de manera global, resolvemos los retos con compromiso y seguimiento local.

Desde nuestra fábrica y HQ en Terrassa junto con la presencia local a través de nuestras 8 filiales, llegamos **a más de 70 países.**



Equipo humano

Ingenieros, diseñadores, técnicos y un sinfín de perfiles profesionales trabajan unidos en tu próximo proyecto.

Diseñamos y fabricamos en nuestro HQ en Terrassa, Barcelona (España) todos los productos de nuestro portafolio.

En nuestro catálogo conviven diseños propios de Lamp junto con creaciones de colaboradores de gran prestigio.

Trabajamos con **alianzas** con expertos en áreas como la sostenibilidad, el acondicionamiento acústico,...

FORMALES

TECNOLÓGICAS

LUMÍNICAS

DOCUMENTACIÓN

NUEVOS
DESARROLLOS

Co-creation

En Lamp **aportamos valor a cada proyecto desarrollando soluciones lumínicas a medida para cada aplicación.**

El servicio de co-creación contempla desde la adaptación de producto existente en catálogo hasta nuevos desarrollos especiales.



WORKTITUDE FOR **WELLBEING**

Entendemos la iluminación como un **elemento fundamental para mejorar el bienestar de las personas**, analizando **los efectos visuales y los no visuales de la luz**.

Creemos que la luz nace en cada luminaria, pero vive en el espacio que ilumina y en la persona que allí trabaja o habita. Se trate de un producto, un servicio o un proyecto, construimos sobre y para los usuarios, teniendo en cuenta las características físicas del espacio y las tareas que se llevarán a cabo en él.

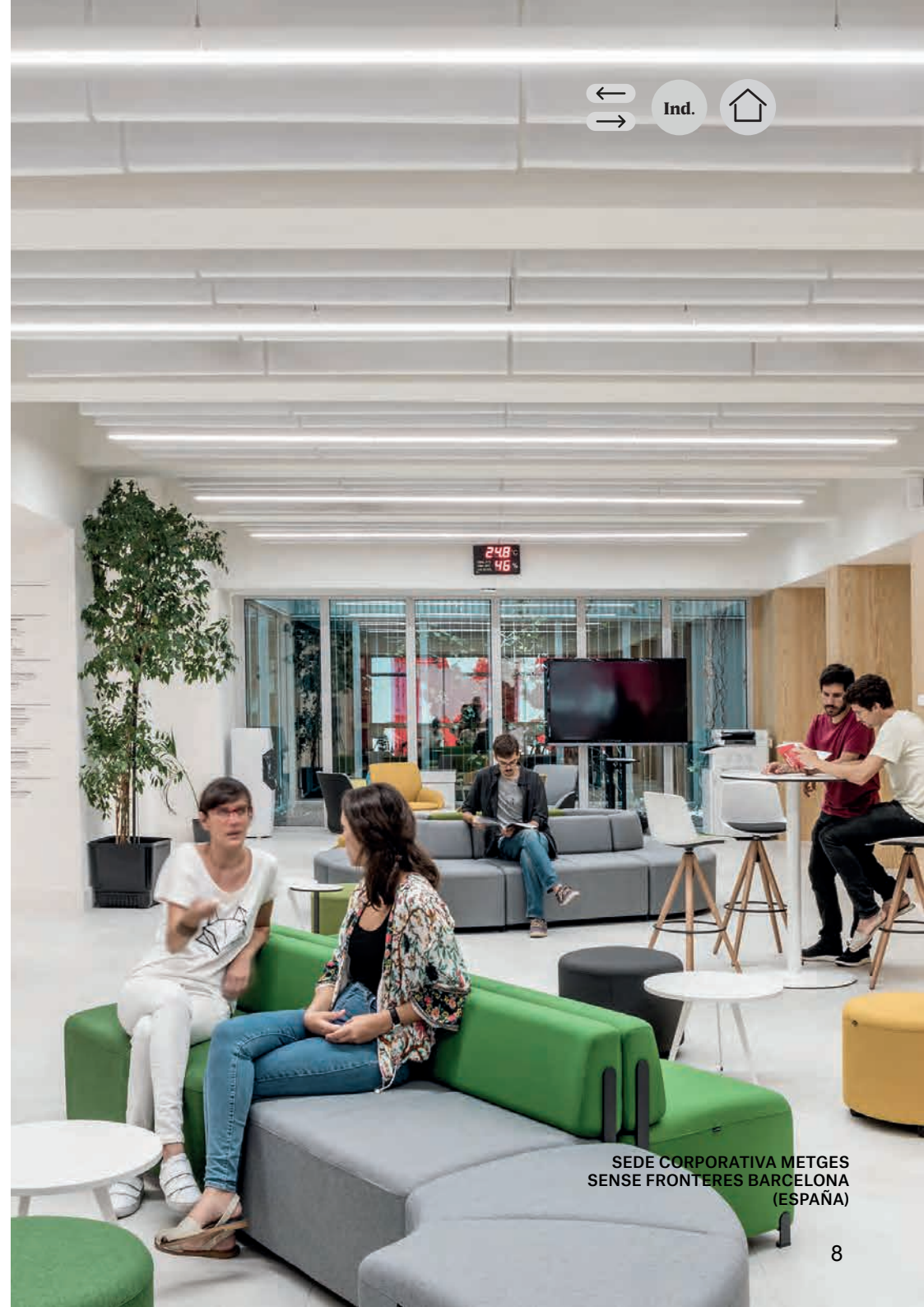



Confort visual

Luminarias con alto confort visual

Especialmente pensadas para que los usuarios desarrollen tareas de concentración y trabajo, con niveles de iluminación medios-altos y un alto requerimiento de confort, como despachos, oficinas, aulas, espacios destinados a la salud y el bienestar.

Luminarias con un bajo grado de deslumbramiento a través de:

- Difusor Tech ultracomfort (UGR<12) y difusor Opal confort (UGR<16)
- Opciones ópticas y alto grado de apantallamiento (UGR<14)
- Emisión directa e Indirecta



Riesgo fotobiológico

Para aquellos espacios con altas exigencias en confort visual debido a un tipo de usuario más sensible, como puedan ser niños o personas de edad avanzada, así como espacios donde los usuarios tengan una exposición prolongada a la luz artificial, como jardines infantiles, centros educativos, hospitales, laboratorios, oficinas, residencias geriátricas ... recomendamos el uso de las luminarias catalogadas como **"Exentas de riesgo fotobiológico - Grupo 0"** según la norma UNE 62471.

+info



Gradiente tecnológico

Implementing a Technological Gradient according to the needs of the project:

+info

Standard LED

Iluminación Dinámica

Tecnología que permite la variación de temperatura de color (2700-6500 K) seleccionando la temperatura de color más adecuada para el nivel lumínico.

Iluminación Wellbeing

"Reconectar con la naturaleza"

Una tecnología que permite emular los biorritmos naturales del ser humano maximizando la activación circadiana. Luz centrada en el bienestar, con elevados niveles de CRI (>97), R9 (<50) y alta estimulación circadiana.

¿QUÉ NOS OFRECE CADA TIPO DE ILUMINACIÓN?

+info

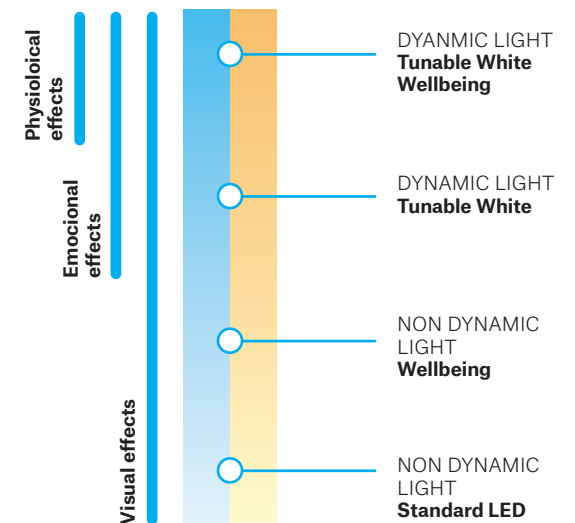

Diseño de itinerarios lumínicos

Hospitales (Habitaciones)

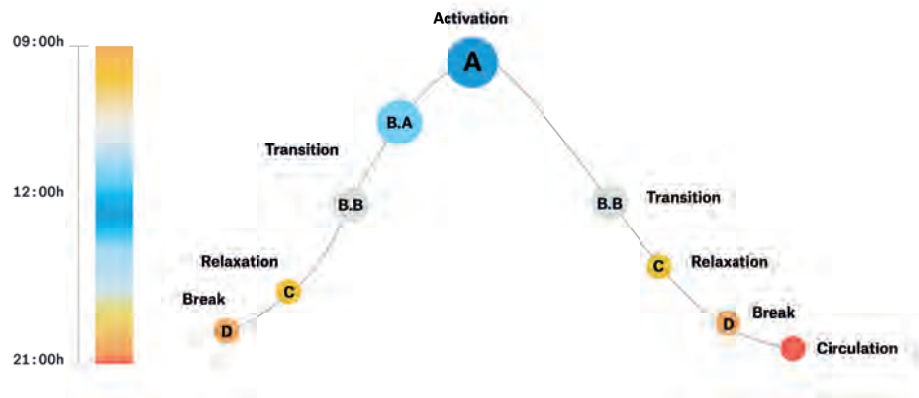

Hospitales (Trabajadores)

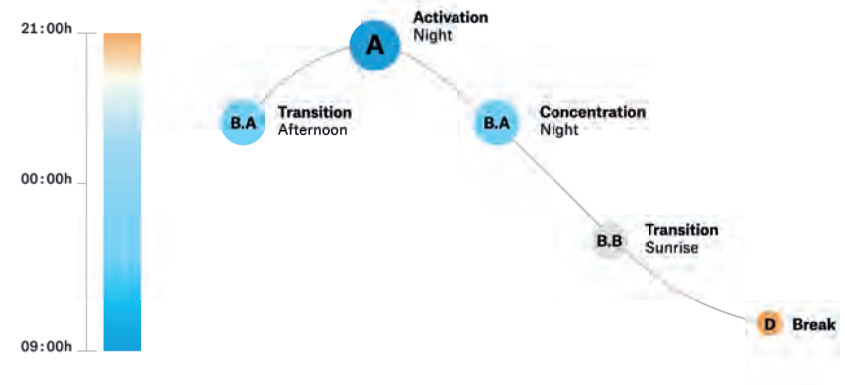

Oficinas

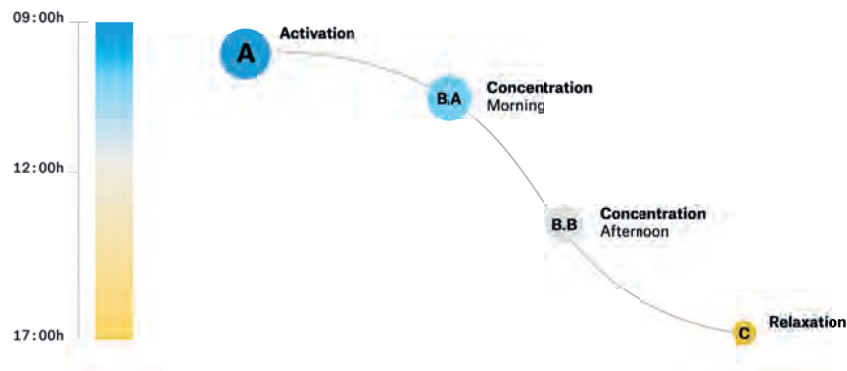

Escuelas

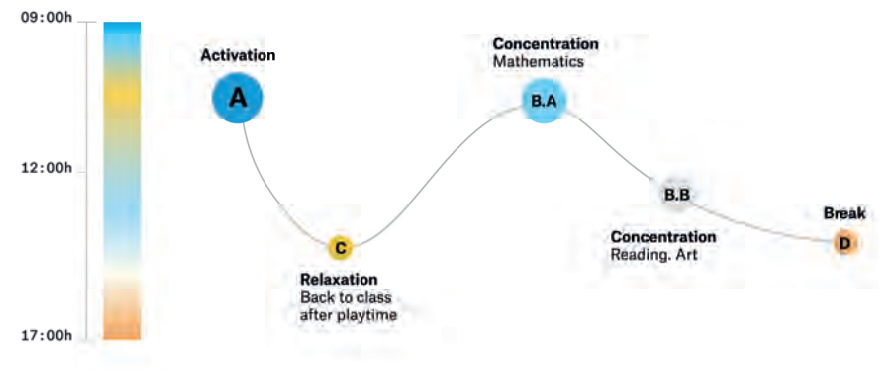



WORKTITUDE FOR **LIFE**

Impulsamos proyectos que generan un **impacto positivo en el medioambiente y promovemos una industria de la iluminación más sostenible.**

Creemos que dar vida a un espacio necesita del esfuerzo compartido de muchas empresas y profesionales que trabajen de manera responsable con el **objetivo de reducir el impacto ambiental a lo largo de toda la cadena de valor.** Nosotros sumamos nuestro granito de arena aportando soluciones realistas, eficientes, sostenibles y alineadas con la realidad climática actual.





Comité de sostenibilidad

Comité estable incorporado dentro del organigrama empresarial, encargado de la **gestión del plan de sostenibilidad**, recolección de **propuestas y priorización de acciones**.

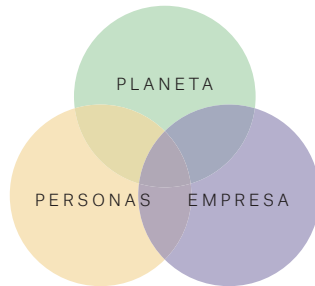

Plan de igualdad y equidad

Forma parte del programa acelerador **Target Gender Equality 2022-2023** para impulsar la **contribución al ODS 5 por la igualdad de género**.



Formación y sensibilidad ambiental

Plan dirigido a nuestros equipos, así como acciones divulgativas externas.



Plan de sostenibilidad

A 3 años, articulado en tres ejes:

- **Ambiental** (Planeta).
- **Social** (Personas, salud y bienestar).
- **Económico** (Empresa, rentabilidad y reputación).



Compromiso público y transparencia

- **Adhesión al Pacto de las Naciones Unidas** como compromiso público de la **alineación con los Diez Principios** universalmente aceptados en las áreas de Derechos humanos, normas laborales, medioambiente y lucha contra la corrupción.
- Apoyo de los **objetivos de las Naciones Unidas plasmados los Objetivos de Desarrollo Sostenible** (ODS).
- Compromiso para la elaboración y publicación del **Informe de progreso** (2023).





Transición energética

- Uso de energías renovables gracias a la **instalación de placas solares en HQ que supone un 40% de autoconsumo.**
- Compromiso para la electrificación progresiva de la flota de vehículos.



Relación con proveedores

- Priorización de **proveedores locales y con políticas de sostenibilidad y reducción de huella de carbono.**
- Optimización de rutas de transporte.
- Fortalecimiento de las relaciones para mejorar la realidad social del entorno.



Reducción de la huella ambiental

Priorizando acciones que nos ayuden a **reducir las emisiones de CO2 y otros GEI** (Gases de Efecto Invernadero) tanto emisiones directas como indirectas.

+info

- **Informe del cálculo GEI** de Lamp contemplando sus emisiones de **Alcances 1, 2 y 3 en 2022.**



Gestión de residuos

Plan de mejora constante en la gestión de los residuos, como reducción de envases de plástico, optimización del packaging eliminando elementos de poliestireno expandido.



Certificaciones y estándares

- Certificaciones ISO 9001 y 14001.
- Clasificación SILVER por ranking Ecovadis, lo que nos sitúa **dentro del 3% de las empresas con un mejor desempeño en cuanto a responsabilidad social.**
- Gestión progresiva de EDP/DAP de nuestros productos partiendo del ACV (Análisis del Ciclo de Vida).
- Uso de aluminio reciclado con sello ASI.

+50%



de las referencias que componen nuestro catálogo cuentan con las **Declaraciones Ambientales de Producto.**





Midiendo el impacto

- Implementación de software para **gestionar y reportar toda la actividad** en torno a la **sostenibilidad y RSC**.
- **ACV progresivo** de nuestras familias de productos.



Análisis del ciclo de vida (ACV)

Muestra del comportamiento **medioambiental del producto expresado en KgCO2** según las fases del ACV.

+info



Eco-diseño

- Implementación de estrategias de diseño y conceptualización para **fomentar la circularidad de nuestros productos y reducir su impacto ambiental**.
- Migración al uso de materiales reciclados como el uso de aluminio reciclado, rPET, rCork... y/o biodegradables.



Investigación y desarrollo

Proyectos de I+D desarrollados por equipos internos propios y expertos externos para desarrollar **información que minimice el impacto ambiental** (generación de nuevos materiales a base de plástico reciclado de residuo post industrial, aditivados libres de bromo, fabricación aditiva,...)



Stormbell 80 R-CORK



MATERIAL Corcho reciclado

COMPOSICIÓN 80-90% tapones de corcho

KG 0,227

PROCEDENCIA 40 tapones de vino reciclado

Stormbell 80 R-PET



MATERIAL Filtro Poliéster

COMPOSICIÓN 20-60% rPET

KG 0,314

PROCEDENCIA 4 botellas de agua recicladas



WORKTITUDE FOR **INNOVATION**

Promovemos y adoptamos proyectos de innovación orientados a la mejora constante de manera transversal, entendiendo que **la innovación es un proceso sistémico y sistemático.**

Nos anticipamos a las necesidades de arquitectos, lighting designers, ingenieros e interioristas para hacer realidad sus proyectos y dar luz al futuro, **creando soluciones lumínicas que den respuesta a las nuevas formas de vida.**

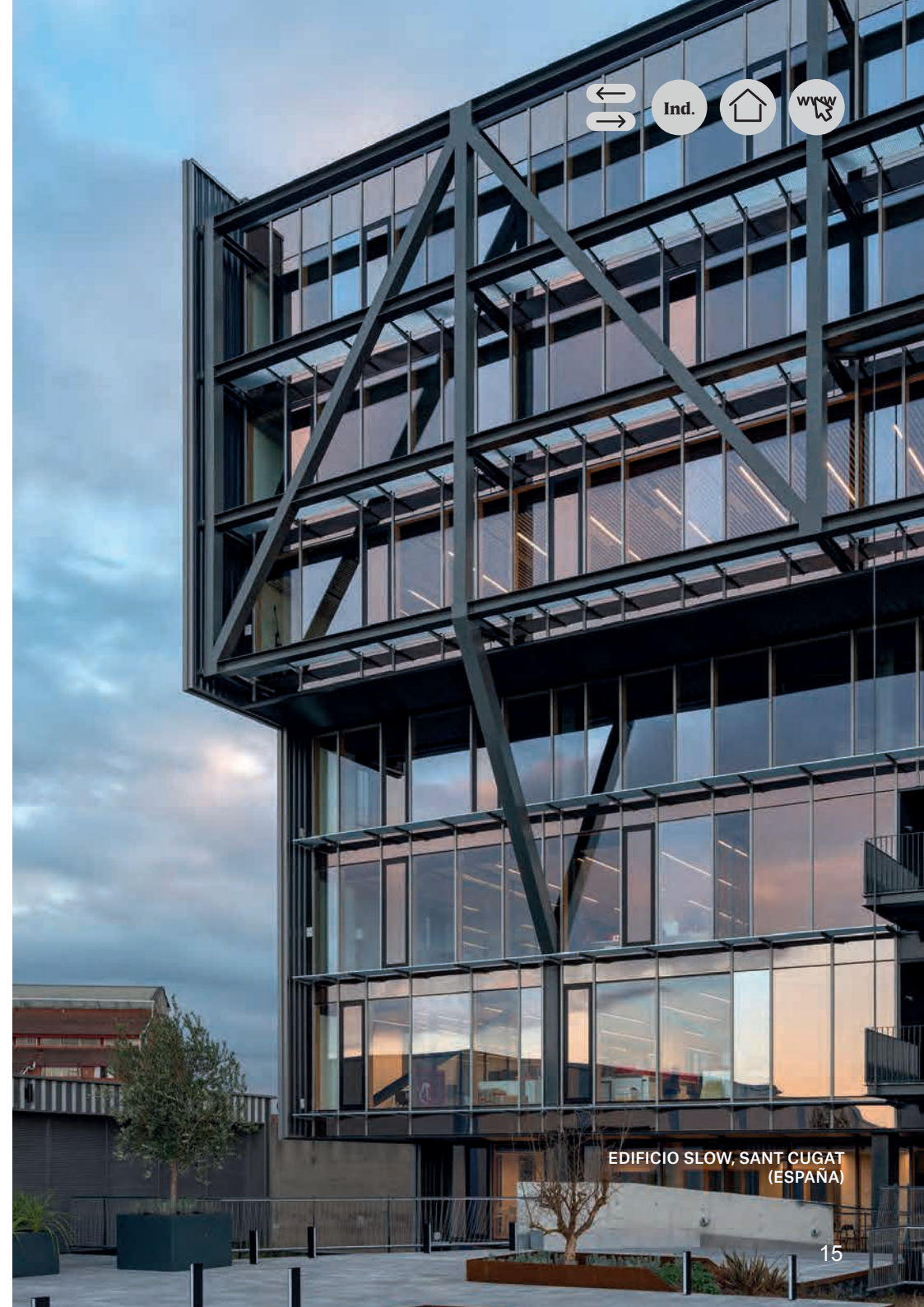

EDIFICIO SLOW, SANT CUGAT
(ESPAÑA)



Grupos de trabajo

Creamos **grupos de trabajo interdisciplinarios**, utilizando metodologías ágiles y autogestionados:

- **Comité de Sostenibilidad**
- **Comité de Innovación**



Segmentos de aplicación

En función de las **diferentes aportaciones que la luz otorga a las experiencias del usuario** en cada espacio, redefinimos los segmentos de aplicación determinados.



Ecosistemas colaborativos

Desarrollamos ecosistemas de **colaboración interna-externa**:

- **Investigación I+D y nuevas materialidades**
- **Partenariado con industrias adyacentes**



Your Light

Creamos un **servicio de asesoría lumínica digital On Demand**, integrado con el proceso de compra y adquisición de luminarias.



The Right Light, Your Light

2018

Identidad corporativa

Redefinición de la propuesta de valor, de la marca y la identidad corporativa y visual.

Open For Innovation

Convertimos en una **organización centrada en el usuario**, generando propuestas de valor en torno a la **aplicación de iluminación innovadora**.

Implantación de la metodología **Design Thinking, Co-Creación y Visual Thinking** para comprender en profundidad las necesidades y requisitos sociales, a través del proyecto NOMADIC: 11 patrones a través de más de 40 entrevistas a 10 perfiles profesionales en más de 10 ciudades de 5 países diferentes, realizado por un grupo transversal de aceleración de innovación.

2019

2020

Transformación para la Innovación

Transformación interna con el fin de preparar a la organización para abrazar **nuevas oportunidades de negocio en la era digital**.

Transformación para la Circularidad

Proyecto de investigación e ideación para **analizar retos y ofrecer nuevas soluciones** que aporten **valor desde la iluminación** a esta nueva concepción **circular de la arquitectura y la edificación**, gracias a un ecosistema de colaboración.

2022



LUZ que vive en el espacio

EDUCATION · OFFICE · COMMON SPACES · HEALTHCARE & WELLNESS · HIGH DENSITY TRANSIT · RETAIL · ARCHITECTURAL OUTDOOR

Education

Luz que cuida y mejora la experiencia educativa.



BIBLIOTECA EL MOLÍ, MOLINS DE REI (ESPAÑA)



PREESCOLAR SAGRADO CORAZÓN, ENVIGADO (COLOMBIA)

Office Luz que promueve la colaboración y la creatividad, tan dinámica como las necesidades de los usuarios.



Common spaces

Luz que crea un ambiente acogedor sin olvidar los aspectos técnicos y un buen control de la iluminación.



CAIXA BANK, MADRID
(ESPAÑA)



SAISHO ORIGINAL TEPPANYAKI,
MAZATLÁN SINALOA (MÉXICO)

Healthcare & Wellness

Luz enfocada al confort y al bienestar, que mejora la experiencia del usuario.



High density transit

Luz eficiente y duradera para comprometerse con los más altos requisitos tanto para los usuarios como para el espacio arquitectónico.

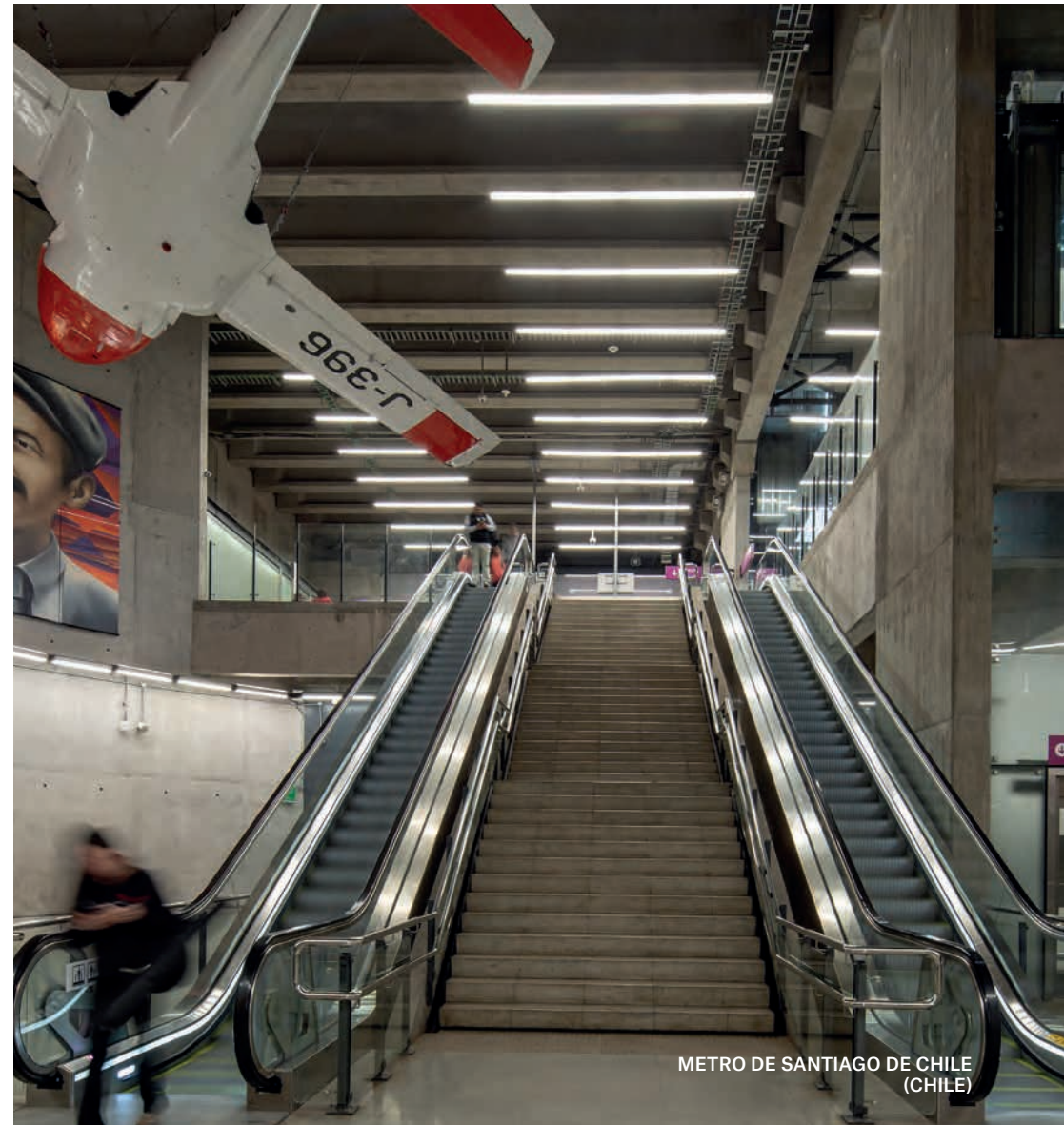

Retail

Luz para resaltar la esencia de sus productos con las características de iluminación más adecuadas.



Architectural Outdoor

Luz adaptada a la escala humana para crear lugares con identidad propia.



Services Lamp +

Servicio de iluminación integradora poniendo en el centro el bienestar del usuario final. Contribuimos al bienestar de las personas a través de la iluminación.

Los proyectos de iluminación integradora que ofrecemos con el servicio Lamp+ siguen las **fases siguientes**:

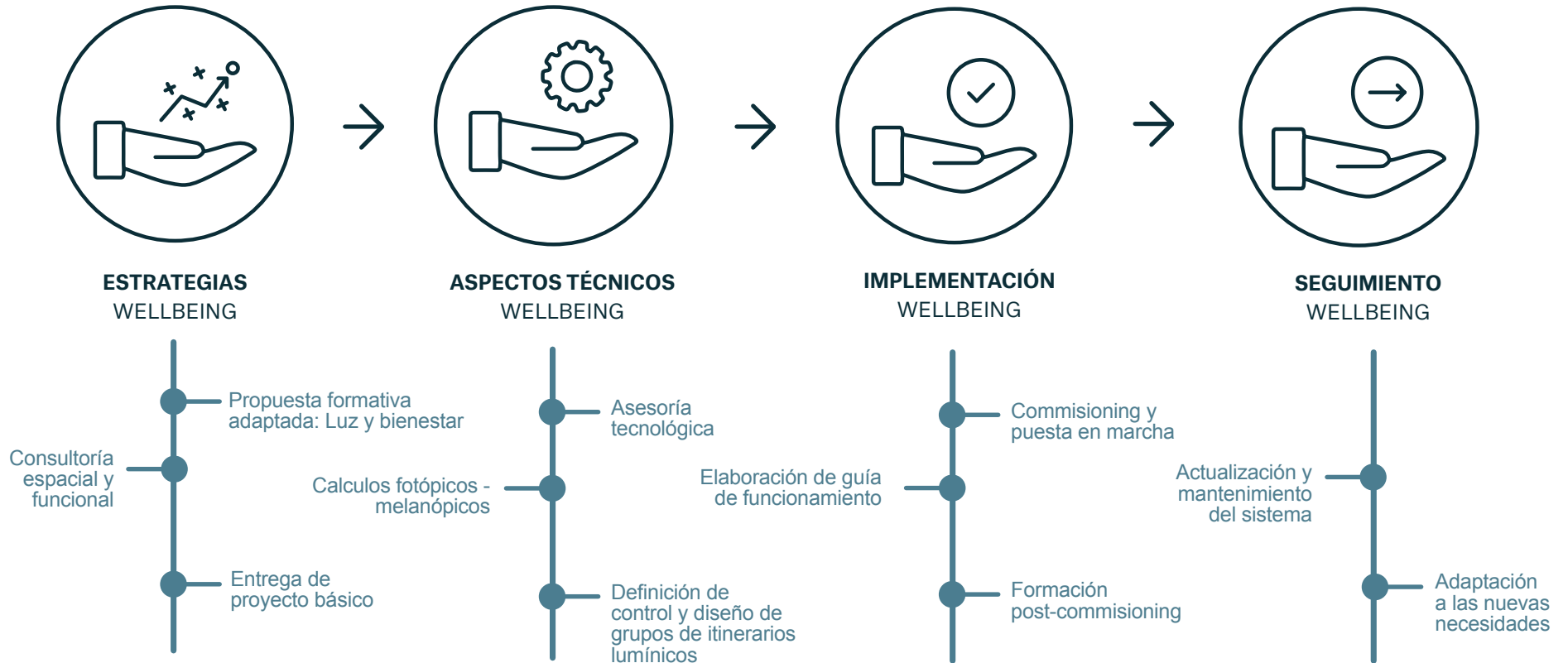

Un proyecto de iluminación integradora se diseña en base a las necesidades biológicas del ser humano, integrando los **efectos visuales y los no visuales de la luz**, entendiendo que la luz no solo tiene un impacto visual, sino que también tiene un efecto emocional y biológico en las personas.



Services



CIRCULIGHT

Upgrade Service

Servicio de actualización tecnológica, para promover la renovación y actualización tecnológica de las luminarias instaladas. De esta forma logramos un aumento de vida de las luminarias, al extender su fase de uso bajo el prisma del Análisis de Ciclo de Vida, aportando soluciones lumínicas más resilientes.



+ Asequible

Generando entre un 15-30% de **ahorro económico** en comparación con la compra e instalación de luminarias nuevas, además de obtener una **mejora de eficiencia energética** que supone ahorros de más de un 50%.

+ Conveniente

La actualización de tecnología lumínica es **más rápido, menos ruidoso y más limpio** que desinstalar e instalar nueva iluminación. **Reduciendo el tiempo de instalación** entre un 20-30%. Además de **mejorar la calidad lumínica** al incorporar últimos avances tecnológicos.

+ Sostenible

Minimiza la huella ambiental del edificio **evitando la generación de residuos** en el proceso de renovación alargando la vida útil de las luminarias. **Reduce las emisiones de CO2** tanto por la reducción de consumo energético, como por la reutilización y reactualización del producto instalado.

EVALUACIÓN, DIAGNÓSTICO Y PROPUESTA DE SOLUCIÓN ÓPTIMA

01

Auditoría y diagnóstico inicial del estado actual de la instalación.

02

Proyecto de viabilidad y consultoría de impacto ambiental.

03

Recuperación de luminarias instaladas.

04

Diagnóstico técnico para evaluar y definir la intervención a realizar.

05

Trabajos de mantenimiento y limpieza.

06

Desarrollo y fabricación de módulos Plug&Play (In-situ/In-House).

07

Digitalización e integración con sistemas de control.

08

Pruebas de calidad, ensayos eléctricos y mecánicos en laboratorio.

09

Certificación de extensión de garantía.

10

Entrega del material y gestión de los residuos generados "in house".

11

Servicio llave en mano (instalación y puesta en marcha).

REACTUALIZACIÓN Y MANTENIMIENTO

INSTALACIÓN, PUESTA EN MARCHA Y CERTIFICACIÓN

Case study

MERCAT DELS ENCANTS, BARCELONA (ESPAÑA)

VIDEO CASE STUDY



La intervención realizada en el mercado Encants, promovida por Mercats de Barcelona, es un ejemplo de transición hacia la circularidad fomentando la **renovación y la generación de infraestructuras resilientes que alarguen su ciclo de vida.**

48% ahorro energético

836 luminarias actualizadas

-22 tn de CO₂ eq a la atmosfera

Calidad lumínica mejorada

SEDES INACAP, SANTIAGO DE CHILE (CHILE)

VIDEO CASE STUDY



El servicio de renovación tecnológica se llevó a cabo en las sedes de INACAP (Instituto Nacional de Capacitación Profesional), logrando implementar una **solución lumínica más sostenible al mejorar la eficiencia energética y aumentando la vida útil de las luminarias instaladas**, a la vez que se mejoró la ergonomía visual.

55% ahorro energético

+20k luminarias actualizadas

-318 tn de CO₂ eq a la atmosfera

Mejor confort lumínico

Light for circularity

APORTE DE VALOR

FASE DE GESTIÓN RCD

- Revalorización de residuos (Directiva UE 2012/19/UE RAEE).

FASE DE USO

- Servicio de actualización tecnológica.



- Soluciones lumínicas alineadas con estrategias de descarbonización:
Alta eficiencia - uso de materiales reciclados.



FASE DE PRODUCCIÓN/ FABRICACIÓN (A1-A3)

- Reducción de la huella ambiental (emisiones embebidas + operacionales).
- Ecodiseño (3R).
- Reducción de residuos (uso de materiales reciclados, optimización packaging).

FASE DE PLANIFICACIÓN Y DISEÑO

- Información huella ambiental (EDP).
- Digitalización (BIM).
- Diseños modulares.
- Facilidad de instalación (Plug & Play).
- Diseño personalizado (Co-Creation).
- Asesoría lumínica y tecnológica.

FASE DE CONSTRUCCIÓN

- Soluciones lumínicas Off-Site.
- Logística personalizada.

SOLUCIONES LUMÍNICAS

1.

PRODUCT INDEX

2.

LIGHTING FOR LIFE

- LCA: Life Cycle Assessment
- EPD: Environmental Product Information
- Ecodesign and Materiality

3.

LIGHTING FOR WELL-BEING

- Visual comfort
- Photobiological risk

4.

TECHNOLOGY

- Technology
- Technological Gradient
- Wellbeing Technology

5.

NOVELTIES

- Kombic 70 Surface
- Kombic 100 Orientable
- Mun G2
- Hermética G2
- Shot 290 & 380 G3

SOLUTIONS

- Technical Ceiling Lighting Solutions
- Nomadic System
- Tech Ultracomfort: Fil 45
- Tech Ultracomfort: Lamptub 60

PALETTES

- Wellbeing
- Be Social
- Materiality
- Foundation
- Retropia

INDOOR

HANCE DOWNLIGHT

Downlight







HANCE
Recessed



HANCE
Semi-Recessed

HANCE SPOTLIGHT

Spotlight







HANCE
1000/2000
Surface



HANCE
1000/2000
Semi-Recessed



HANCE
1000/2000
Track



HANCE
3000/4000
Surface



HANCE
3000/4000
Semi-Recessed



HANCE
3000/4000
Track

HANCE 48V

Spotlight





HANCE 48V
500



HANCE 48V
1000/2000

OCULT DOWN.

Downlight







OCULT
Frame / Trimless

OCULT SYSTEM

System







OCULT
1000/2000
Surface



OCULT
1000/2000
Semi-Recessed



OCULT
1000/2000
Track

IMAG

Spotlight







IMAG G3
Track

KOMBIC

Downlight





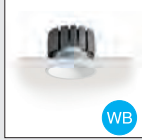

KOMBIC 70
Downlight



KOMBIC 100
Downlight



KOMBIC 150
Downlight



KOMBIC 200
Downlight

Downlight





KOMBIC 70
Surface



KOMBIC 100
Surface



KOMBIC 150
Surface



KOMBIC 200
Surface

DOMO 220

Downlight





DOMO 220

INDOOR

MOODY

Downlight



MOODY
ø 100
Downlight

MOODY
ø 72
Downlight

MOODY
Square
Downlight

MOODY
Asymmetric
Downlight

MOODY
Adjustable
Downlight

Spotlight



MOODY
Pendular

PUZZLE

Downlight



PUZZLE

RING

Downlight



RING
Round

RING
Square

RING
Round

STORMBELL 80

Downlight



STORMBELL 80

STORMBELL

Downlight



STORMBELL

STORMBELL
Deco

QUIET

Downlight



QUIET



MUN

Downlight / Wall



MUN LIGHT
300

MUN LIGHT
450

MUN LIGHT
600

Wall



MUN DARK
120

MUN DARK
180

MUN DARK
300

AMBIENT

Wall









AMBIENT

INDOOR

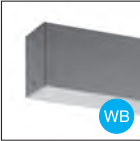
FIL

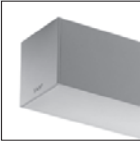
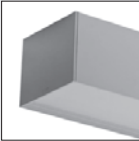

General

FIL 35 FIL 45 FIL 45 CURVE FIL SYSTEM FIL 50 FIL 70 FIL 120

LAMPTUB 60



General

LAMPTUB 60

LAMPTUB 80



General

LAMPTUB 80

PLAT

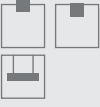

General

PLAT PLAT TECH

MODULAR CUSTOM



General

MODULAR CUSTOM EFFICIENCY MODULAR CUSTOM AIR

HERMETICA



General

HERMETICA

FINE LED STRIP



General

FINE LED STRIP FINE CURVE

GENERAL ACC



General Acc

SUPPORTS SUSPENSIONS

HEALTH SOLUTIONS





Clinic

CLINIC CLINIC Gas

TRANSPORT SOLUTIONS



Metro

STGO TLSE BCN

TRACK

Track







TRACK 48V TRACK 230V

OUTDOOR

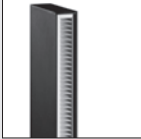
SETI

Path







SETI
Soft

SETI
Spot

B-SIDE

Path







B-SIDE

B-SIDE
360

PUCK



Path

PUCK

MUN IP65



Wall

MUN IP65

LUP



Wall

LUP 70
Wall Mounted

LUP 110
Wall Mounted

Downlight







LUP 110
Downlight

LUP 162
Downlight

GAP



**Uplight
Downlight**

GAP

XTREMA





Uplight

XTREMA

TRACE

Wall

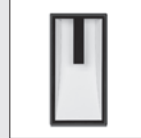
TRACE 100
Symmetric

TRACE 200
Aymmetric

TRACE 200
Aymmetric

TRACE 200
Symmetric

URBAN 100



Wall



URBAN 100

DUIT

Wall









DUIT

OUTDOOR

BAZZ

General





BAZZ
Aymmetric
Frame

BAZZ
Opal
Frame

BAZZ
Symmetric
Frame

BAZZ
Wall Washer
Frame

General

BAZZ AIR
Aymmetric
Air



BAZZ AIR
Opal
Air

BAZZ AIR
Symmetric
Air

BAZZ AIR
Wall Washer
Air

BAULINE

General







BAULINE

BAULINE
Air

FLUT

Floodlights

FLUT 180

FLUT 280

SHOT

Spotlight







SHOT 80

SHOT 120

SHOT 180

SHOT 290

SHOT 380

NIU

Urban



NIU

OWL

Urban



OWL

GENERAL ACC.

Supports



VIAL SYSTEMS



Análisis de Ciclo de Vida (ACV)

El análisis de ciclo de vida nos permite analizar y evaluar el **desempeño ambiental de nuestros productos “de la cuna a la tumba”**, cuantificando los impactos ambientales, en cada una de las etapas acorde a la norma **UNE-EN 15804:2012+A2:2**.

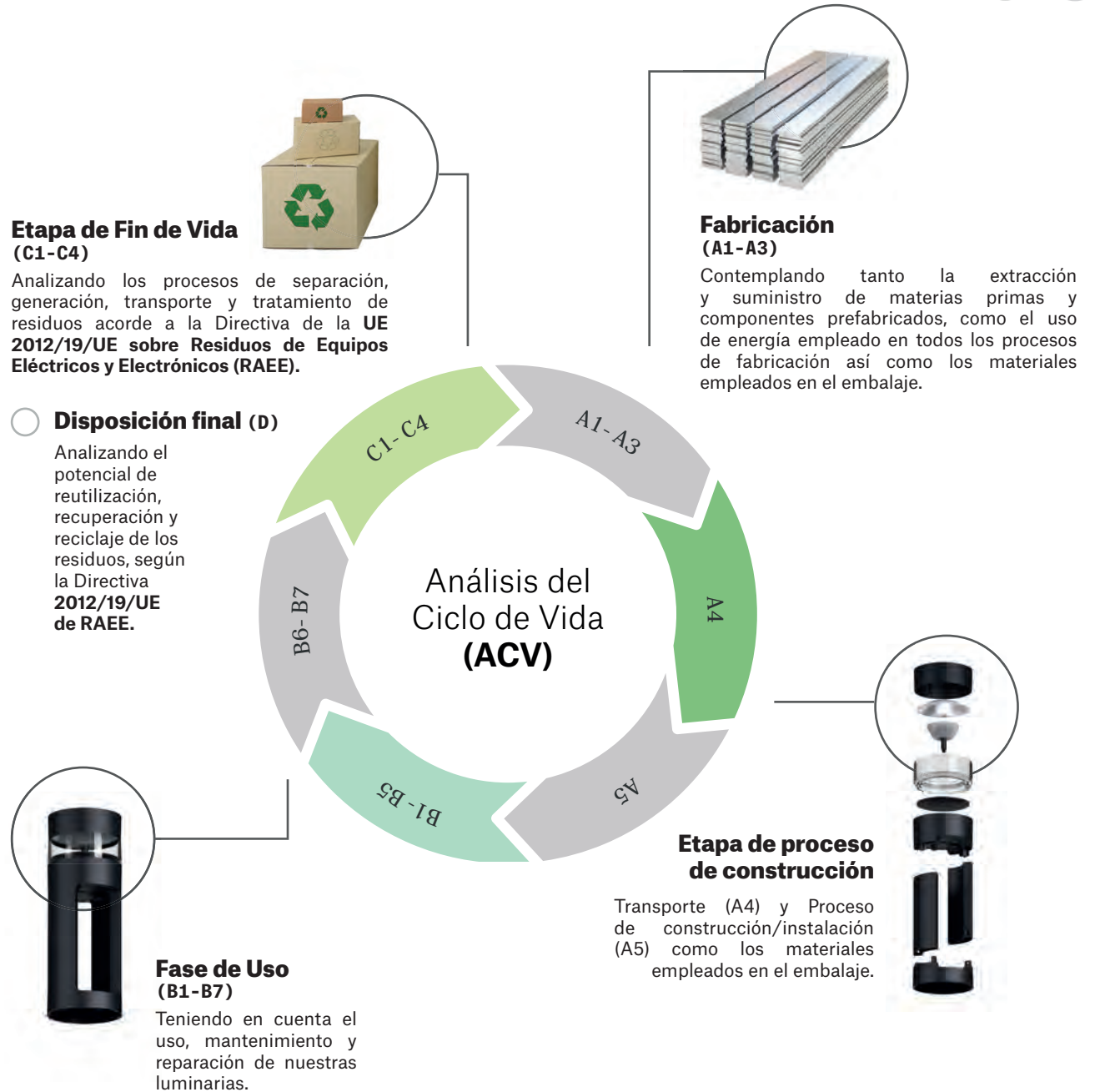



Los impactos medioambientales analizados son entre otros: el **calentamiento Global (GWP)**, el **agotamiento de la capa de ozono (ODP)**, la **acidificación (AP)** o el **agotamiento de los recursos (APD)**.



El ACV de nuestros productos es un proceso imprescindible que nos permite continuar tomando medidas que minimicen el impacto ambiental de nuestras luminarias, y poder ofrecer mejores soluciones lumínicas para cada proyecto.



Información Medioambiental de Producto (EPD)

Actualmente contamos con las **Declaraciones Ambientales de Producto** de más del **50%** de las referencias que componen nuestro catálogo.



(Environmental Product Declaration)
ISO 14025 & EN 15804

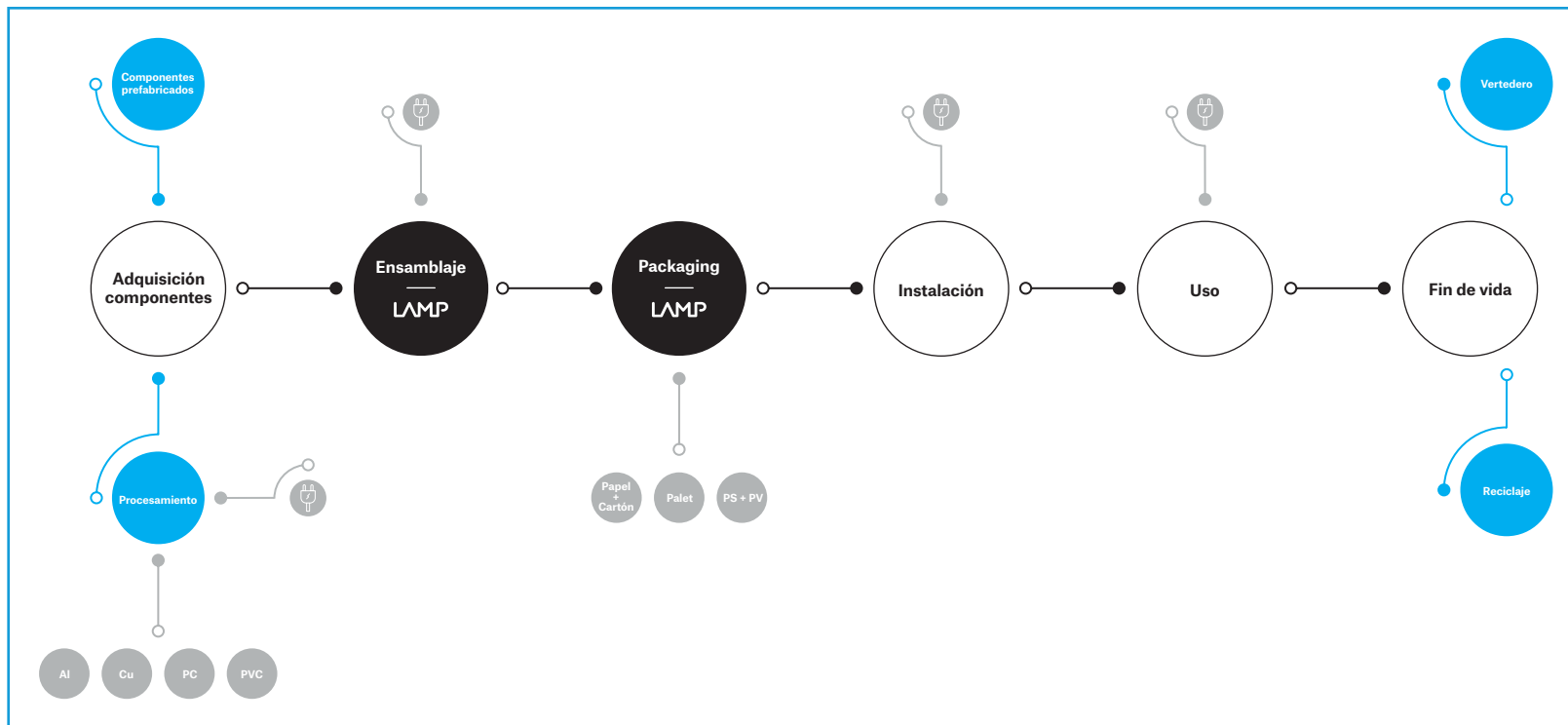



Contribuimos con **las acciones e información necesarias para favorecer la transición hacia una economía circular**, y lograr los objetivos establecidos para frenar la crisis climática, mostrando nuestro impacto, tanto en datos absolutos (Kg CO2 eq), como la relación porcentual del impacto en cada fase.

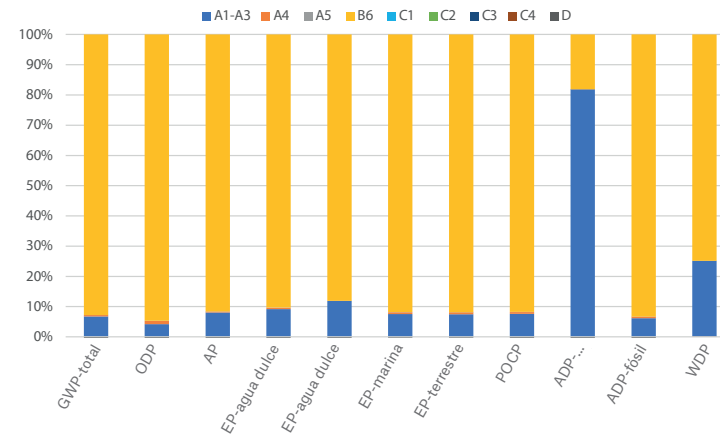
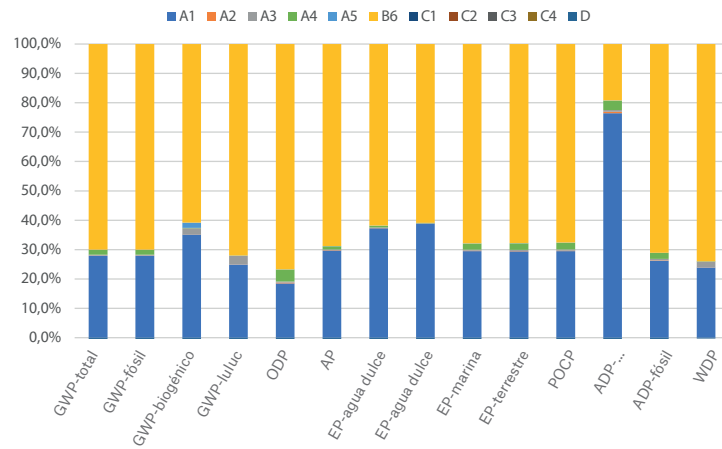

Encuentra esta información en:





Ecodiseño y materialidad

Perfil Aluminio R



- Aluminio reciclado
Reducción de un 70% de las emisiones directas de carbono durante su fabricación
- Uso de 5% de energía en comparación con el proceso original.
- Ahorro **270 Tn CO² Eq / año**
- Reducción **42 %** de la huella de CO²

Polycarbonato : R-PC FR white™



“Reflector fabricado en **polycarbonato reciclado R-PC FR WHITE™ con retardante de llama libre de bromo**. Grado inflamabilidad V0 según UL94.



Material	Corcho Reciclado
Composición	80-90% tapones de corcho reciclados
Kg	0,227
Procedencia	40 tapones de vino reciclados

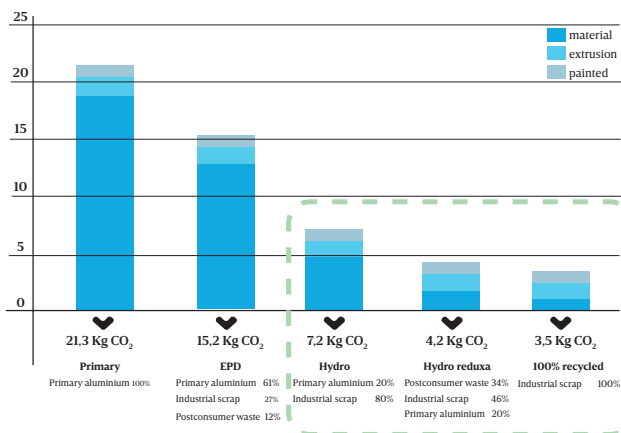

- Ahorro **70 Tn CO² Eq /año**
- Reducción **96 %** de la huella de CO² (por pieza)



Material	Fieltro Poliéster
Composición	20-60% rPET (botellas y otros envases reciclados)
Kg	0,134
Procedencia	4 botellas de agua recicladas



Confort visual

Luminarias con alto confort visual

Especialmente pensadas para que los usuarios desarrollen tareas de concentración y trabajo, con niveles de iluminación medios-altos y un alto requerimiento de confort, como despachos, oficinas, aulas, espacios destinados a la salud y el bienestar.

Luminarias con un bajo grado de deslumbramiento a través de:

Difusores tech (UGR <12) y Opal confort (UGR <16)

Opciones ópticas y alto grado de apantallamiento (UGR <17)

Emisión directa e Indirecta

FIL 35 TECH



LAMPTUB 60 TECH



KOMBIC 70 OPTIC



KOMBIC 100 OPTIC



FIL 35/ 45 / FIL 70



DIR/IND

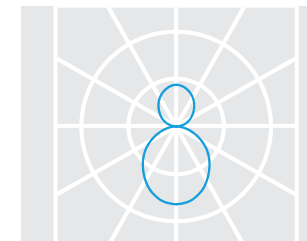

FIL 45



FIL 45 TECH



OCULT

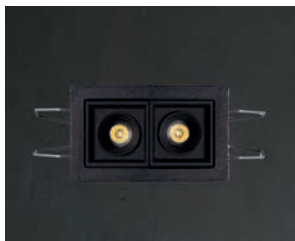

MOODY



LAMPTUB 60



AMBIENT





Riesgo fotobiológico

Luminarias exentas de riesgo fotobiológico

Para aquellos espacios con altas exigencias en confort visual debido a un tipo de usuario más sensible, como puedan ser niños o personas de edad avanzada, así como espacios donde los usuarios tengan una exposición prolongada a la luz artificial, como jardines infantiles, centros educativos, hospitales, laboratorios, oficinas, residencias geriátricas ... recomendamos el uso de las luminarias catalogadas como **“Exentas de riesgo fotobiológico - Grupo 0” según la norma UNE 62471.**

KOMBIC DOWNLIGHT



KOMBIC SURFACE



FIL



PLAT





Tecnología

Iluminación Dinámica

Tecnología que permite la variación de temperatura de color (2700-6500 K) seleccionando la temperatura de color más adecuada para el nivel lumínico.

FIL 45



PLAT



KOMBIC



KOMBIC SURFACE



Iluminación Wellbeing

Una tecnología que permite emular los biorritmos naturales del ser humano maximizando la activación circadiana. Luz centrada en el bienestar, con elevados niveles de CRI y alta estimulación circadiana.

FIL 45



KOMBIC 100

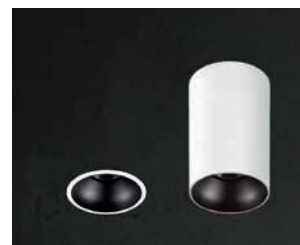

KOMBIC 150



STORMBELL 80





Gradiente Tecnológico

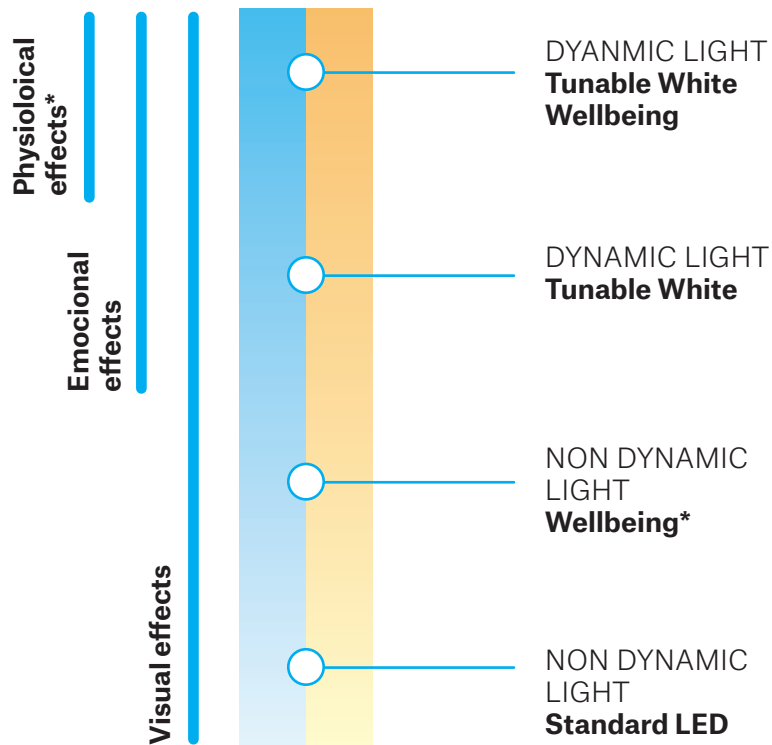

	MONOCOLOR	MONOCOLOR WELLBEING	BLANCO DINÁMICO	BLANCO DINÁMICO WELLBEING
ILUMINANCIAS APTAS PARA TAREAS DE CONCENTRACIÓN	●	●	●	●
CONTRASTES DE LUMINANCIAS	●	●	●	●
REGULACIÓN DE NIVEL DE ILUMINACIÓN	●	●	●	●
CRI>80	●	●	●	●
R9>50	—	●	—	●
SINCRONIZACIÓN CON ILUMINACIÓN NATURAL (CCT VARIABLE)	—	—	●	●
ITINERARIOS LUMÍNICOS	—	—	—	●
SIMULACIÓN ESPECTRAL DE LA LUZ NATURAL	—	●	—	●
ESTIMULACIÓN CIRCADIANA (CCT VARIABLE)	—	—	—	●



Tecnología Wellbeing

Reconexión con la naturaleza

La tecnología Wellbeing se centra en el **bienestar de las personas**, ya que permite **respetar los biorritmos naturales del ser humano**, reduciendo las emisiones más agresivas para la visión y maximizando las más efectivas para la activación circadiana.

Reproduce todas las longitudes de onda visibles en la luz, imitando de manera precisa la **luz natural del sol**.

En Lamp estamos en constante actualización de esta tecnología en nuestros productos, para ofrecer una óptima **estimulación circadiana**, especialmente necesaria durante las primeras horas del día y considerando regularmente las métricas de calidad de color, como CRI y TM-30, así como las distribuciones de potencia espectral (SPD).

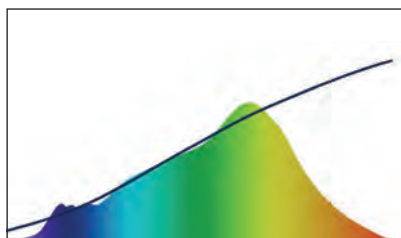

Espectro Lumínico
LED Wellbeing

La tecnología LED Wellbeing adapta su distribución espectral para ofrecer una curva continua más similar a la de la luz natural.

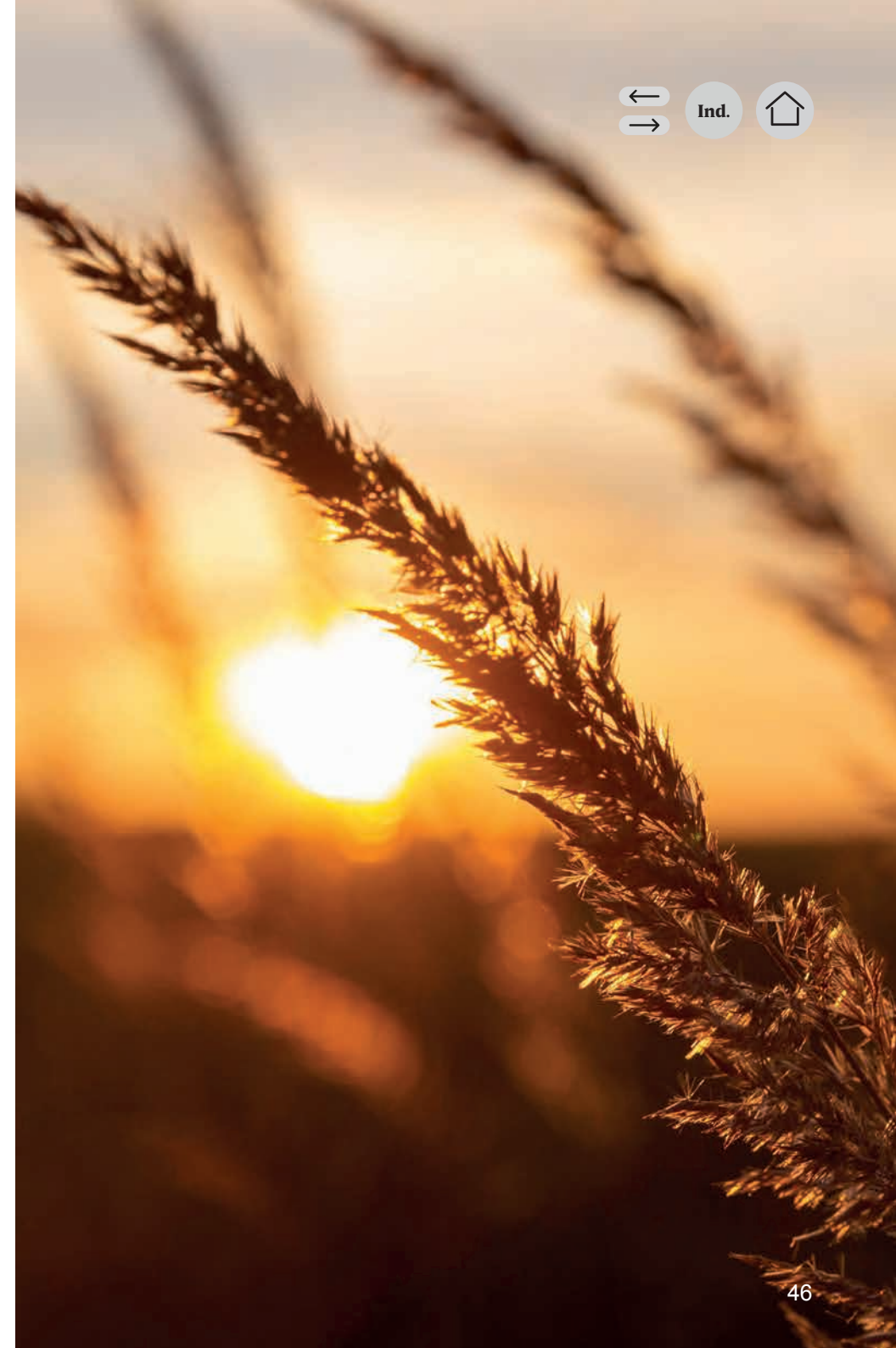



Tecnología Wellbeing

¿Qué beneficios aporta la tecnología Wellbeing?

- **Impacto positivo en el bienestar humano**
Gracias a su distribución espectral, y a su optimización en las emisiones correspondientes a los 480 nm, ofrece una alta activación circadiana, ayudando a regular los ciclos de sueño y vigilia, mejora los niveles de energía promoviendo una sensación general de bienestar.
- **Mejora la percepción visual**
Proporciona una mejor calidad y definición visual, reduciendo la fatiga ocular y mejorando el confort visual.
- **Excelente reproducción cromática**
CRI95 en downlights / CRI98 en sistemas lineales.
- **Accesibilidad y aplicabilidad**
Aplicamos la tecnología en una amplia gama de productos para diferentes entornos y espacios, mejorando la calidad de la luz y la experiencia de los usuarios.

FIL 45



STORMBELL 80



KOMBIC 100

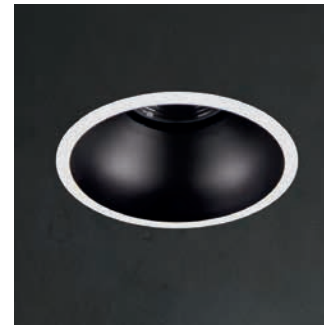

KOMBIC 150



Paletas

Wellbeing

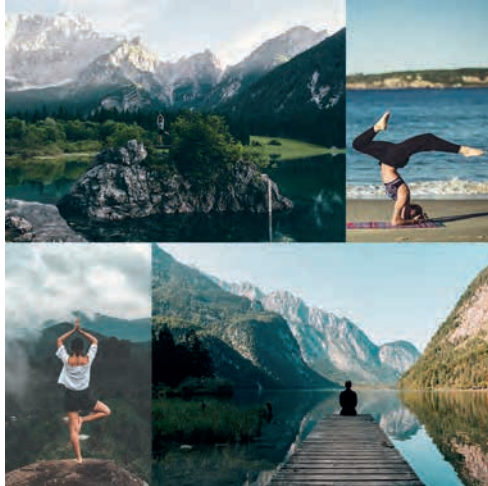

Be Social



Materiality



Foundation



Retropia



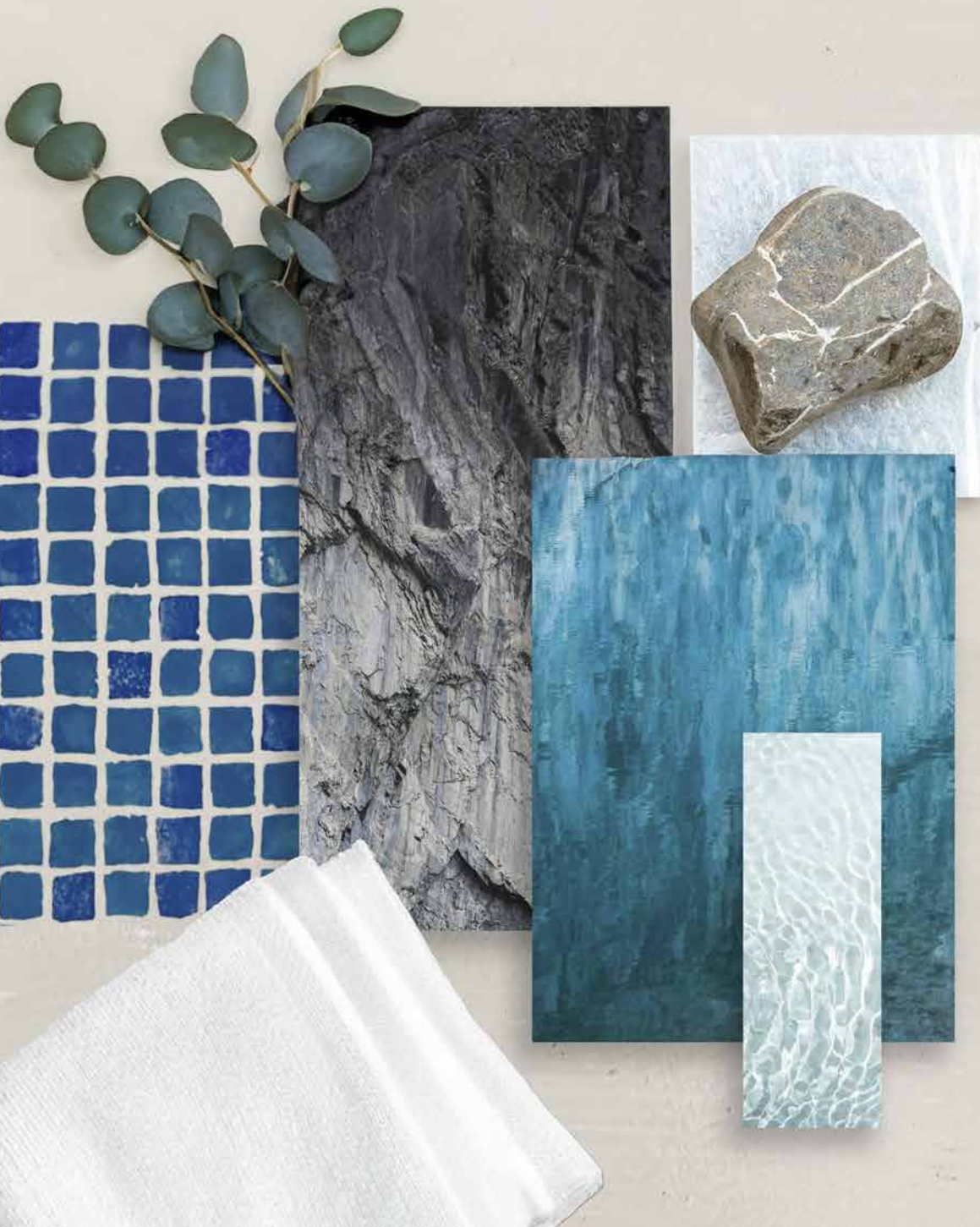

Wellbeing

Bienestar físico y emocional.



4050-R90B



1505-Y10R



7024



4030



7001



Be Social

Interrelaciones.



4050-R90B



1050-B10G



7502-R



2070-Y80R



2011



Materiality

Recuperación de la materialidad,
experiencias reales.

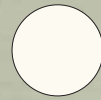

1505-Y10R



7024



3010-G



2010-Y20R



3013

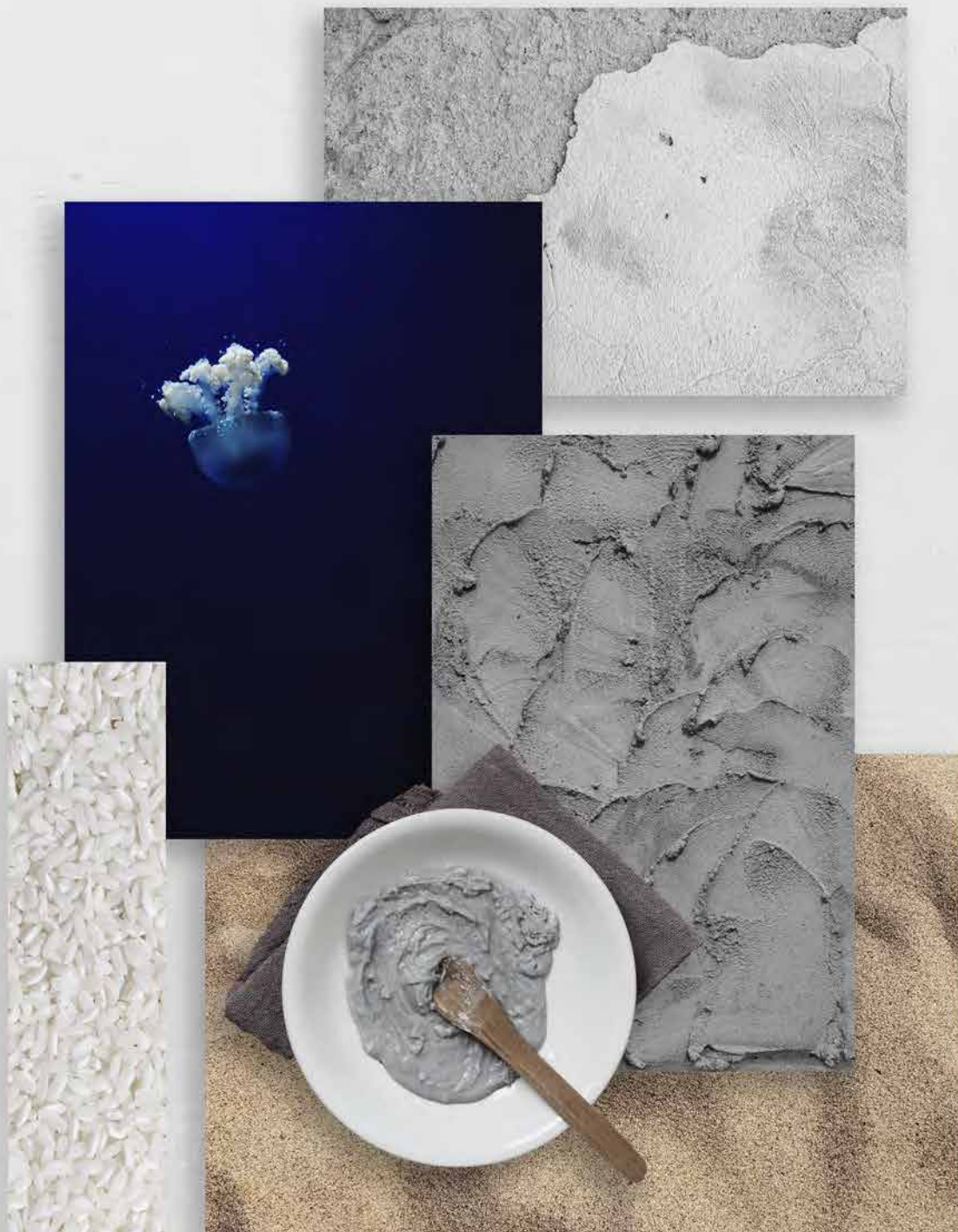

Foundation

Enfrentando lo complejo.



5003



1505-Y10R



7036



7043



9002



Retropia

Soñar con lugares pasados,
imaginar un futuro cercano.



5009

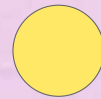

1016



4010

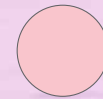

3015



6027

TECHNICAL CEILING LIGHTING SOLUTIONS

Design by Lamp

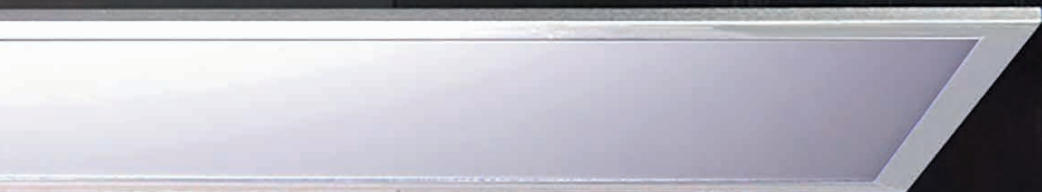

PLAT OPAL

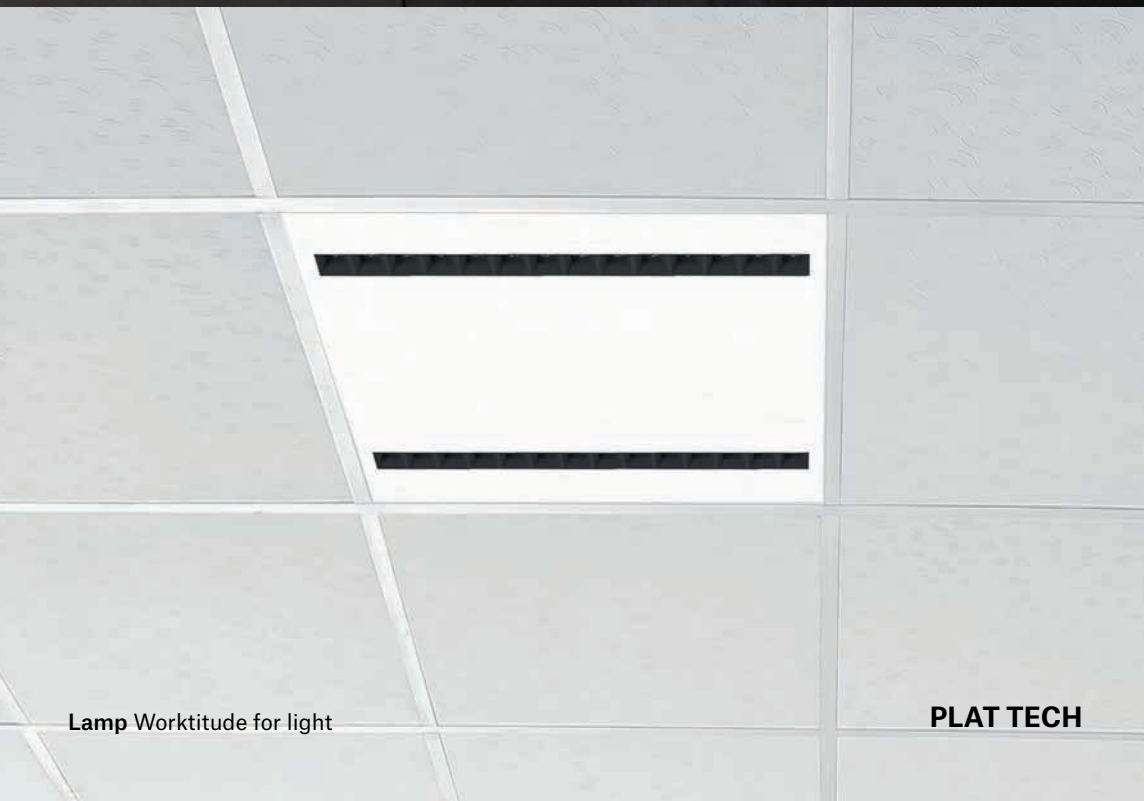

PLAT TECH



+ INFORMACIÓN TÉCNICA

Ind.



Plat

OFFICE/
EDUCATION

La solución para techos técnicos con control de deslumbramiento y gran eficiencia.



Confort y bienestar

PRISMÁTICA UGR <19
TECH UGR <12.

Riesgo Fotobiológico R0.

Flicker free.



Eficiencia energética

Eficacia hasta **123lm/W**.



Calidad óptica

Luminosidad uniforme en un mínimo espesor.



+ INFORMACIÓN TÉCNICA

Ind.



Plat Tech

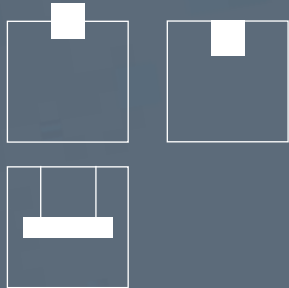

INSTALACIÓN

Plat Tech es perfecta para la **iluminación de interiores** fácilmente instalable en **techos con perfiles visto y ocultos**, así como en **techos de escayola**.



DARK LIGHT: ILUMINACIÓN DISCRETA

Plat Tech satisface los requisitos del límite de oscuridad que la clasifica como Dark Light: es **inferior a 200cd/Im 2 por encima de un ángulo de visión de 60°**. Así, **crea una iluminación discreta que respeta la comodidad del usuario y no causa deslumbramiento**.



EFICIENCIA

Diseñada con una combinación de reflector que elimina el deslumbramiento y óptica de alta eficiencia, garantizando una iluminación sin molestias visuales y un **consumo energético optimizado**.



+ INFORMACIÓN TÉCNICA

Ind.



Plat

MODELOS

Opal

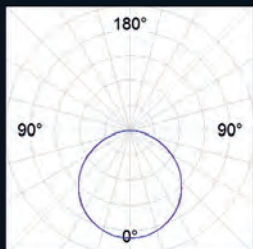

Prismatic

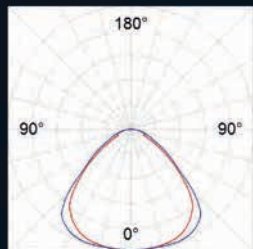

Tech

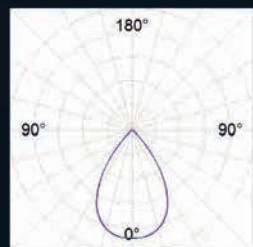

TAMAÑO

600x600 mm
1200x300 mm

FUENTE DE LUZ

CRI 80/90
3000 / 3500 / 4000 K
Tunable White (TW)

IP

40/54
65

CONTROL

ON/OFF
DALI
1-10V
CASAMBI

ACCESORIOS ADICIONALES

Sensor de luminosidad
Sensor de presencia
Batería de emergencia 3/5h
Conector rápido

INSTALACIÓN



Perfilería vista



Perfilería vista, placa semi-empotrada

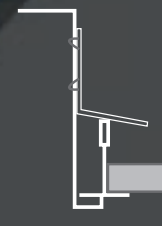

Perfilería vista, luminaria semi-empotrada



Techo de yeso, luminaria semi-empotrada



Perfilería "T" oculta, techo no desmontable

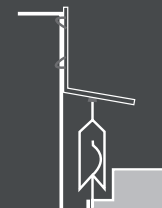

Perfilería para techo de placas metálicas







Plat

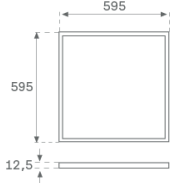
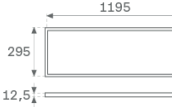
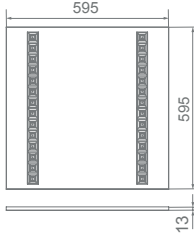

+ INFORMACIÓN TÉCNICA

Ind.



Modelos	OPAL	PRISMATIC	TECH
			
Dimensiones			
Longitudes	600x600mm	1200x300mm	600x600mm
Lm LED	4100lm	3500lm	4100lm
IRC	80/90	80/90	90
Ángulos apertura	 Opal 114°	 Prismatic 95°	 Tech 70°
Temp. Color	3000 / 4000 / TW	3000 /3500 (Active Warm) / 4000 K	3000 / 4000 K
Equipo	ON/OFF - DALI 1-10 V CASAMBI		
IP	40 / 54 / 65 (front) / 67		
Acabados	Blanco		



MODULAR CUSTOM EFFICIENCY



+ INFORMACIÓN TÉCNICA

Ind.



Modular Custom

OFFICE



Confort y bienestar

PRISMÁTICA (con lámina óptica)
UGR <19.

Riesgo Fotobiológico R0.

Driver Flicker free.



Eficiencia energética

Eficacia hasta **125lm/W**.



Diseño modular

Solución adaptable a:

- Diferentes modulaciones
- Formatos de techo
- Requerimientos lumínicos
- Retorno de aire a plenum



Modular Custom

PERSONALIZACIÓN

Altamente customizable y adaptable a cualquier tipo de techo: modular, continuo o registrable. Esto permite satisfacer las necesidades específicas de cada proyecto, ofreciendo **soluciones a medida.**



MODULAR CUSTOM EFFICIENCY EFICIENCIA ENERGÉTICA

El modelo Efficiency destaca por una eficiencia superior a 120lm/W, ofreciendo una iluminación óptima y de calidad, mientras consume menos energía, lo que se traduce en ahorro de mantenimiento y **una menor huella ambiental.**



MODULAR CUSTOM AIR CALIDAD DEL AIRE

El modelo Air de Modular Custom incorpora ranuras para extracción de aire con retorno a plenum.

Este sistema es más eficiente y mantiene la calidad del aire en el espacio, asegurando una ventilación adecuada. El retorno de aire permite extraer el aire utilizado en el espacio interior y redirigirlo hacia un área designada, donde se puede filtrar, tratar y reacondicionar antes de volver a suministrarlo.

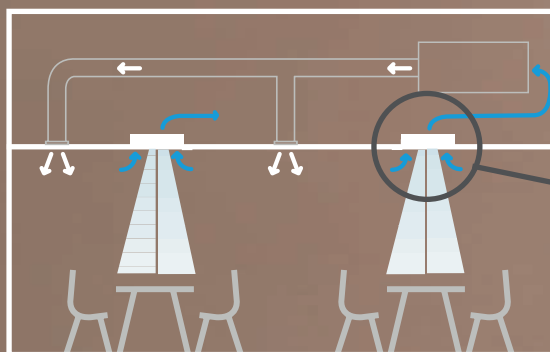

— Línea blanca: **expulsión de aire**

— Línea azul: **retorno de aire**

**Capacidad de extracción de 40l/sg-144m3/h
para formato de 900x300 mm**

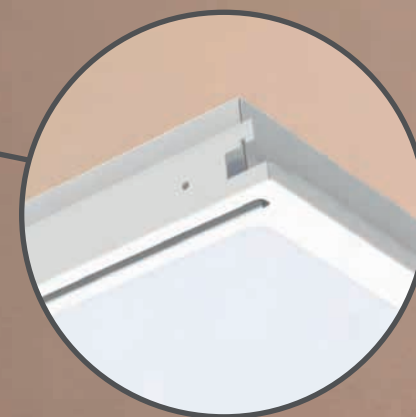



+ INFORMACIÓN TÉCNICA

Ind.



Modular Custom

MODELOS

Efficiency

Air

Modelo con aberturas de retorno de aire a *plenum*

TAMAÑO

600x600 mm
1200x120 mm
900x300 mm
1200x300 mm
1200x600 mm

IP

40/54

ACCESORIOS ADICIONALES

Sensor de luminosidad
Sensor de presencia
Batería de emergencia 3/5h
Conector rápido

FUENTE DE LUZ

CRI 80/90
3000 / 3500 / 4000 K
Tunable White (TW)

CONTROL

ON/OFF
DALI
1-10V
CASAMBI

INSTALACIÓN

Nos adaptamos a diferentes tipos de techo técnico



Perfilería vista

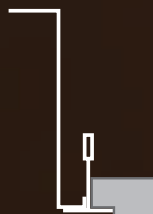

Perfilería vista, placa semi-empotrada

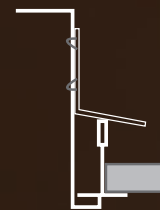

Perfilería vista, luminaria semi-empotrada



Montaje suspendido para techos de lamas o especiales
***Solo en Air**

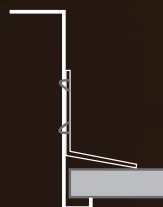

Techo de yeso, luminaria semi-empotrada

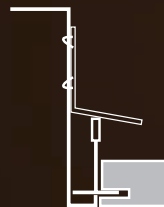

Perfilería "T" oculta, techo no desmontable



Perfilería para techo de placas metálicas

Modular



[+ INFORMACIÓN TÉCNICA](#)

Ind.



Modelos

EFFICIENCY



AIR



Dimensiones

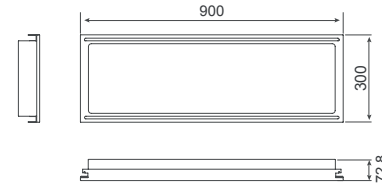
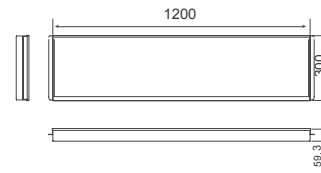
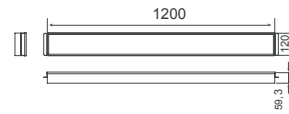
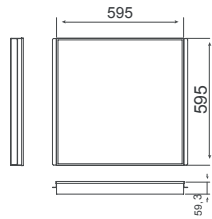

Longitudes 600x600mm 1200x120mm 900x300mm 1200x300mm 1200x600mm

Lm LED 4200lm

IRC 80

Ángulos apertura



Temp. Color 3000 / 4000 K / TW

3000 / 4000 K

Equipo ON/OFF - DALI 1-10 V CASAMBI

IP 40

Acabados ○ Blanco



Hermetica

HEALTHCARE &
WELLNESS/
OFFICE

Diseño hermético para salas de ambiente controlado.

Disponible en dos versiones: cuadrada y rectangular.



Confort y bienestar

Exenta de riesgo fotobiológico UNE 62471.

Flicker-free: Cumplimiento con métodos IEEE estándar 1789 -2015 LED y según NEMA 77-2017 (.Pst LM<1.0 y SVM <0,6).

Difusor prismático: UGR<19.

Dos distribuciones luminosas: basic (opal) y confort (prismatic).

Gradiente tecnológico.

3000K - 4000K.

CRI 80.



+ INFORMACIÓN TÉCNICA

Ind.



Ecodesign criteria

Eficacia hasta **135lm/W**.

Fabricadas con materiales de superficie lisa y no porosos que facilitan su limpieza y desinfección. Esto es importante para mantener la higiene en las salas blancas.

Junta de estanqueidad para mantener un entorno limpio y libre de contaminación.

Luminaria de registro inferior para posibilitar una actualización tecnológica. Tapa inferior con cadena de seguridad.



Facilidad de instalación

Conectores rápidos de entrada y salida para facilitar su mantenimiento y reducir el tiempo de montaje.

Bajo mantenimiento, reduce los tiempos de inactividad y los costos asociados. Esto es especialmente importante en entornos críticos donde se requiere un funcionamiento continuo.

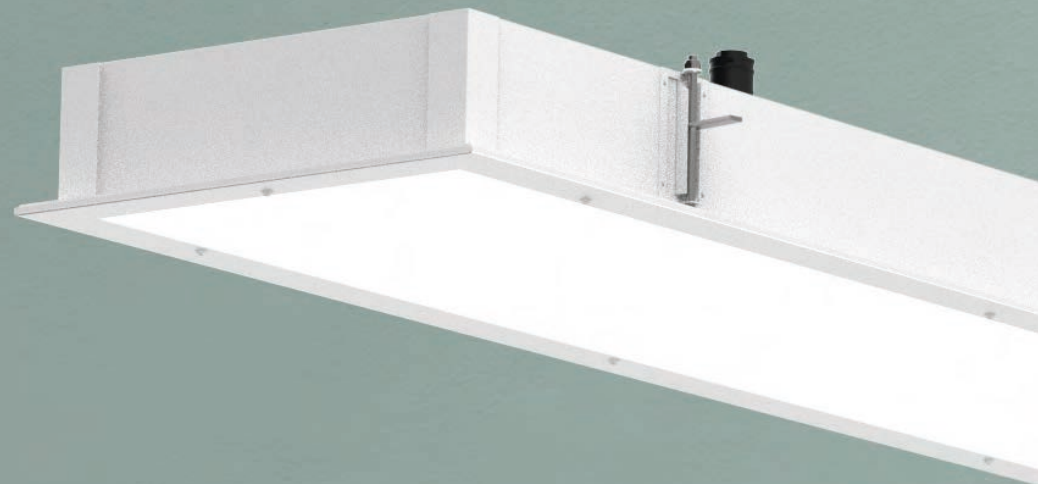



+ INFORMACIÓN TÉCNICA

Ind.



Hermetica G2

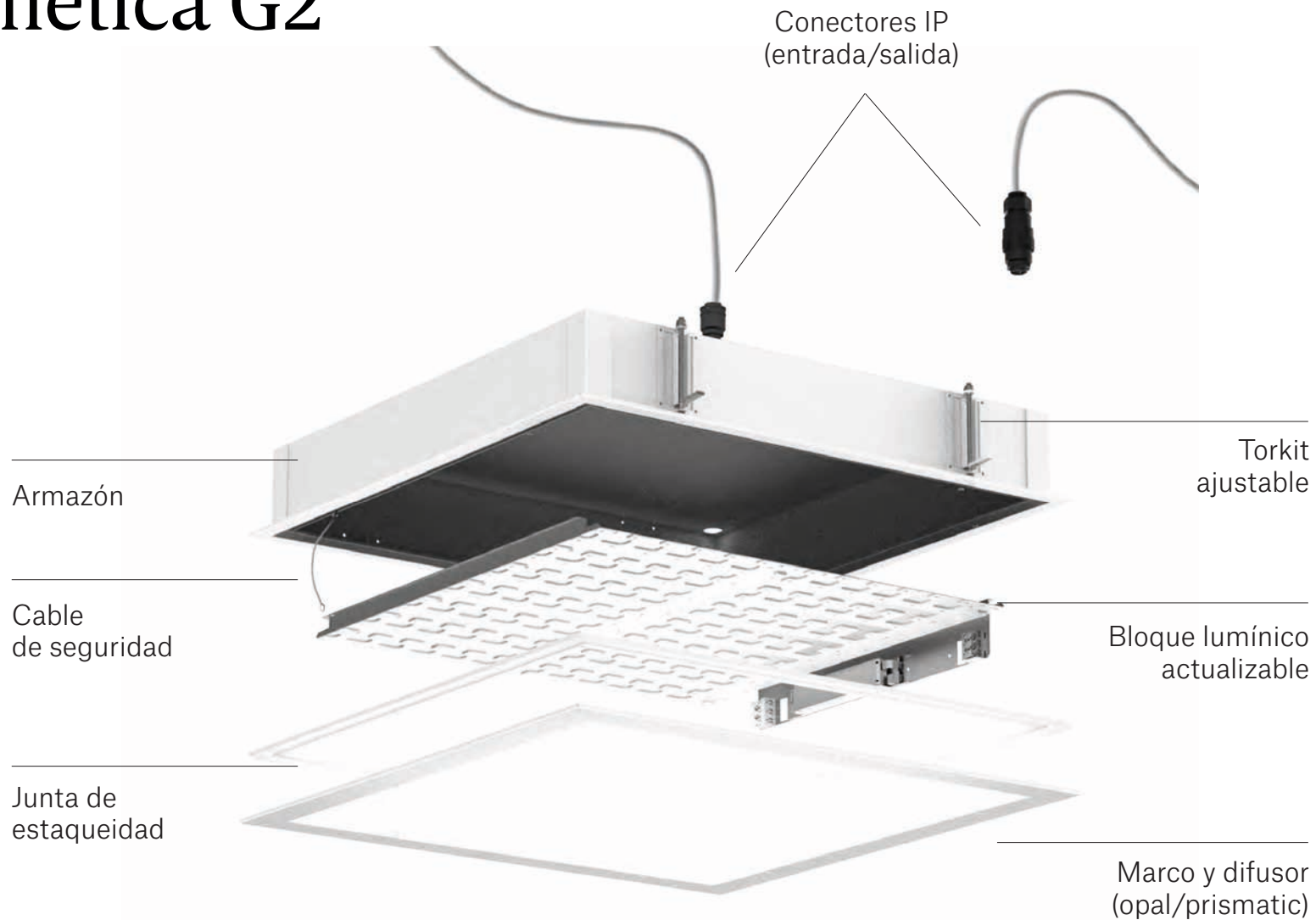

Hermetica G2



+ INFORMACIÓN TÉCNICA

Ind.



Modelos

OPAL



PRISMATIC



Dimensiones

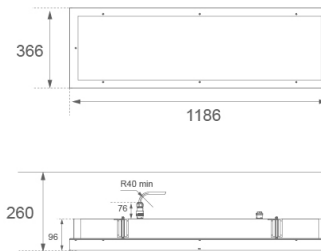
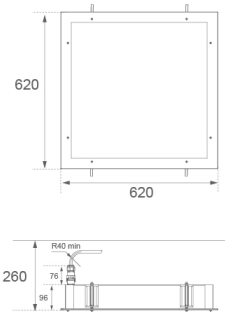

Longitudes 600x600mm 1200x300mm

Lm LED 5600lm

IRC 80

Ángulos apertura



Opal



Prismatic

Temp. Color 3000 / 4000

Equipo ON-OFF / DALI

IP 65

Acabados Blanco

SISTEMA NOMADIC

Espacios flexibles, adaptables a las nuevas necesidades de cada uso.



NS Sistema Nomadic



Diseño versátil

Iluminación que se adapta a las necesidades del diseño arquitectónico y lumínico.



Integración en el espacio

Sistema modular que facilita cualquier composición y fácilmente integrable en múltiples tipos de techos.



Facilidad de instalación

Simplificación en la coordinación de las instalaciones MEP y de montaje.



Variedad tecnológica

Múltiples opciones para cubrir cualquier necesidad.



Dinámico

Sistema de iluminación que se adapta fácilmente a los cambios de configuración especial.



Sostenibilidad

Diseñado bajo un concepto de economía circular que facilita la recuperación y reutilización de las luminarias. Sistema altamente eficiente desde el punto de vista energético, primando la utilización de materiales sostenibles.

NS Sistema Nomadic

TRACK



+

LAMPTUB 60



STORMBELL 80



KOMBIC 100



HANCE



+info

NS Sistema Nomadic

Diseño versátil e integración en el espacio



Espacios con instalaciones vistas (sin falso techo).

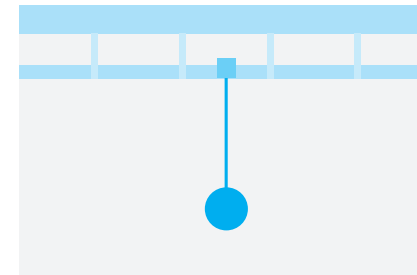

Espacios con instalaciones ocultas (falso techo continuo).

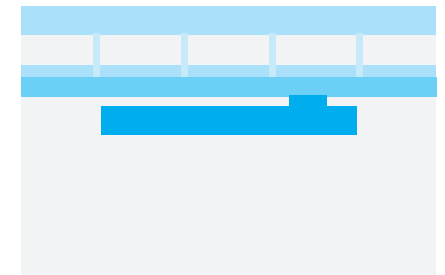

Espacios con instalaciones ocultas (bandeja metálica registrable).

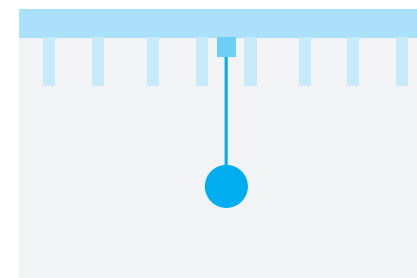

Espacios con instalaciones vistas (falso techo de lamas).

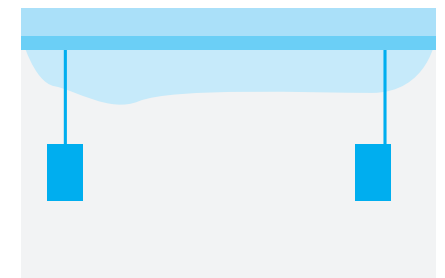

Espacios con instalaciones vistas (techos multiformato).

NS Sistema Nomadic



Espacios con instalaciones ocultas (falso techo de lamas acústicas).



Espacios rehabilitados (Integración en estructuras existentes).

NS Sistema Nomadic

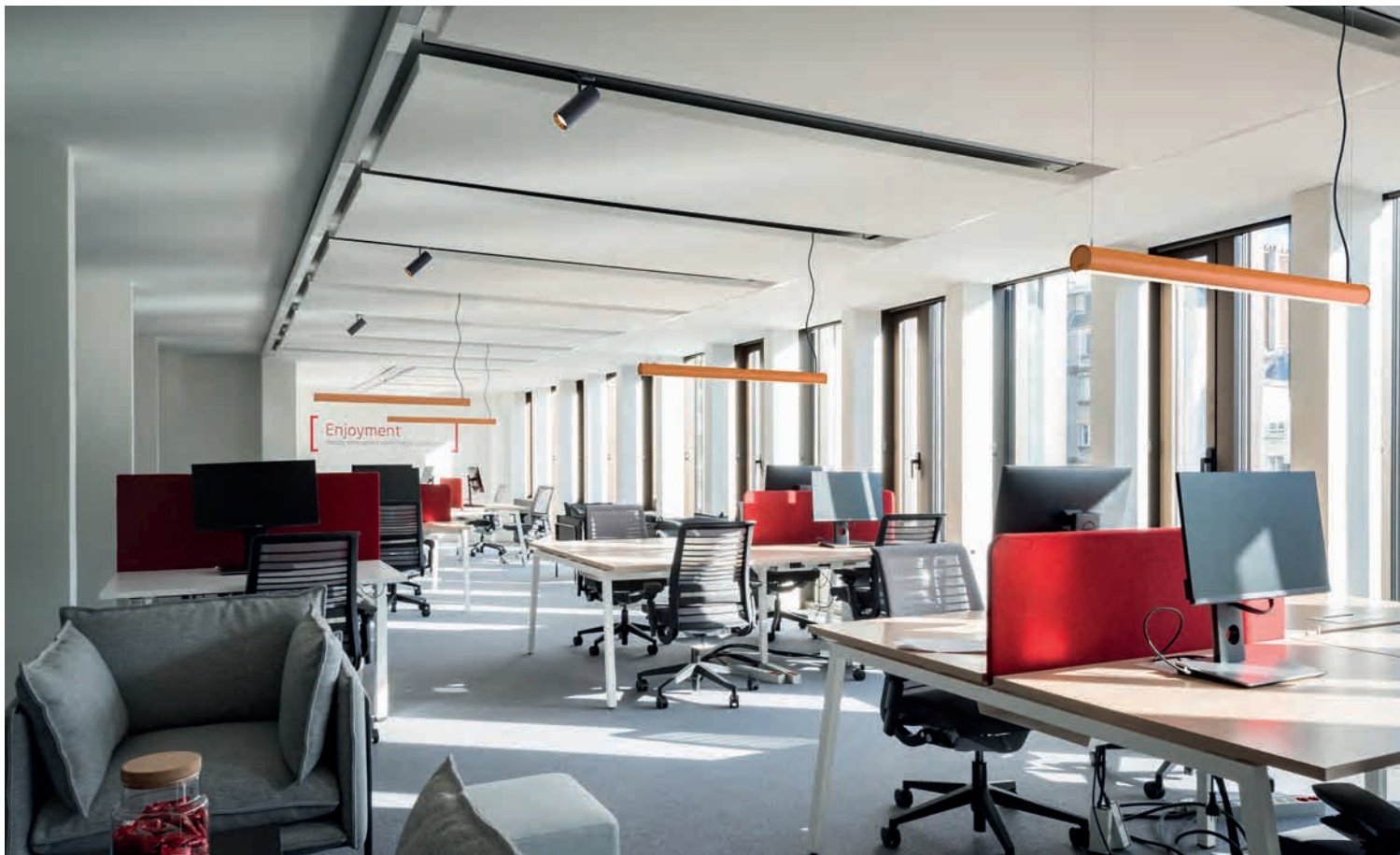

Espacios con instalaciones semi-ocultas (Paneles acústicos de gran formato).

QUIET

Portfolio de soluciones integradoras de confort lumínico y acústico.

By Lamp Aistec

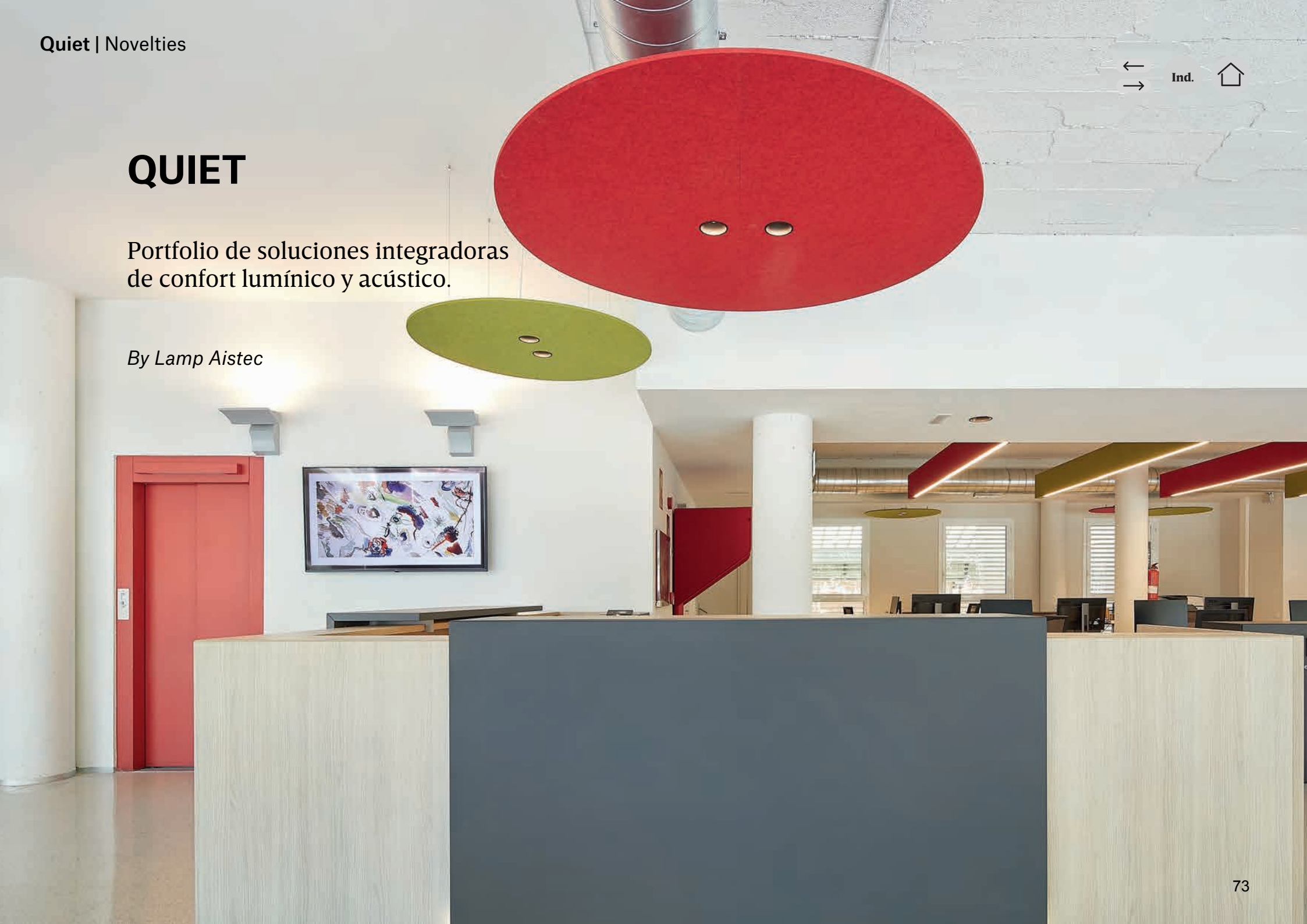



Solución integral Wellbeing

Combinado soluciones de confort acústico y lumínico, con las más altas especificaciones técnicas.



Low VOC

Bajas emisiones volátiles sin formaldehídos.



Salud visual

Las soluciones lumínicas integradas cumplen con altos requisitos:

Control del deslumbramiento activo:
difusor opal y opal confort.

Luminarias “exenta de riesgo” RG0 según la normativa de Riesgo Fotobiológico UNE 62471.

Modelos de **alto confort visual con gran ángulo de apantallamiento, reflectores negro y utilización de ópticas ultra confort.**

Flicker free.



+ INFORMACIÓN TÉCNICA

Ind.





Adaptabilidad y personalización

A la gran versatilidad técnica de las luminarias, se une una carta con 56 colores, acabados personalizados (troquelados, biselados, impresiones) y **desarrollos a medida**.



Servicio de asesoría

Para integrar a la perfección el proyecto lumínico y acústico.



Criterios de ecodiseño

Diseñado bajo un concepto de economía circular que facilita la recuperación y reutilización de las luminarias. El material fonoabsorbente realizado con un tejido "woven non woven" compuesto de fieltro a base de PET reciclado (procedente de botellas). Algunas de las luminarias incorporan materiales reciclados como aluminio o plásticos.



ECONOMÍA AMBIENTAL

Diseño confort



Confort térmico



Confort lumínico



Confort acústico

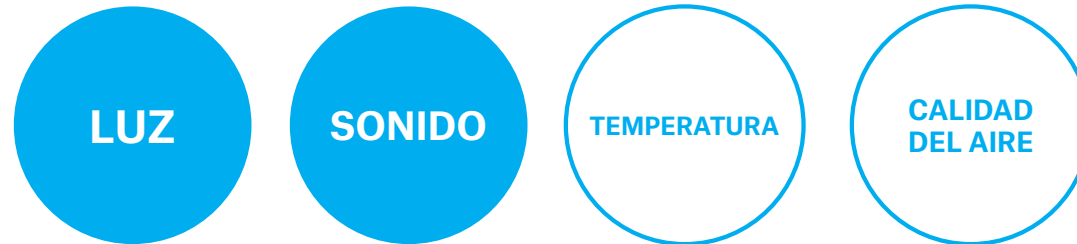



+ INFORMACIÓN TÉCNICA

Ind.



CONFIGURADOR

QUIET STANDARD

BAFFLE FIL 45



ROUND KOMBIC



SQUARE OCULT



QUIET CUSTOM

BAFFLE "DIE CUT"

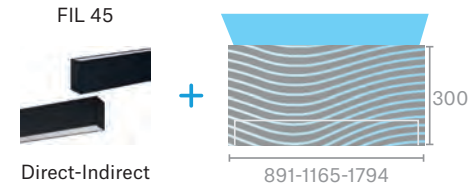

RECTANGLE CORNER

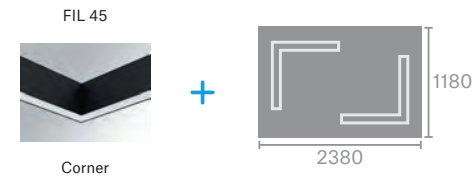

HEXAGON OCULT

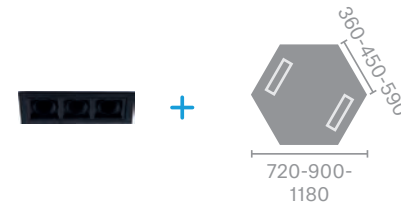



+ INFORMACIÓN TÉCNICA

Ind.



CARACTERÍSTICAS FONOABSORBENTES



Material rPET

Compuesto por un 75% de plástico rPET reciclado.



Absorción acústica

α_w 0.6-0.95



Emisiones volátiles

LOW VOC (sin emisiones de formaldehídos)



Resistencia al fuego

B-s1, d0



+ INFORMACIÓN TÉCNICA

Ind.



Quiet Baffle Fil



FIL 45
Opal Comfort





+ INFORMACIÓN TÉCNICA

Ind.



Quiet Round Kombic



QUIET
ROUND S



KOMBIC 100
Opal W/M
Optic
Reflector B/M

QUIET
ROUND L



KOMBIC 150
Optic
Reflector B/M



790

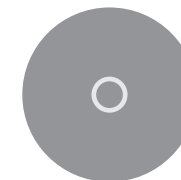

1180



+ INFORMACIÓN TÉCNICA

Ind.



Quiet Square Ocult



Ocult

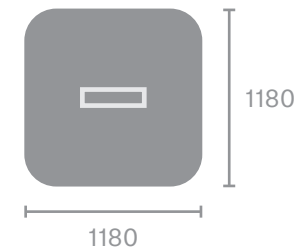



+ INFORMACIÓN TÉCNICA

Ind.



Quiet Rectangle Ocult



Ocult

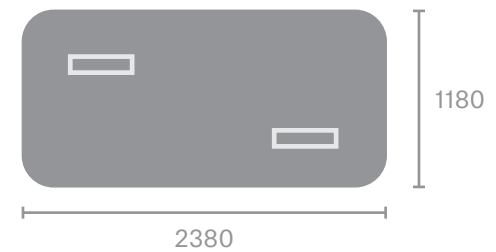



+ INFORMACIÓN TÉCNICA

Ind.



Quiet Hexagonal Ocult

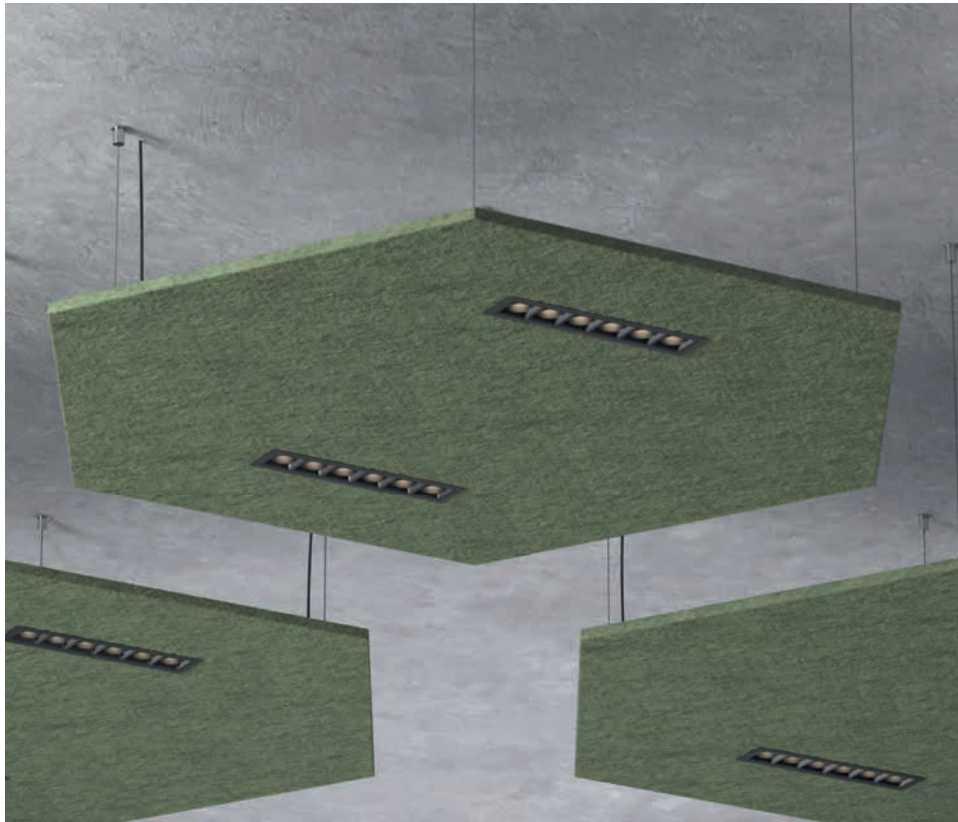

Ocult

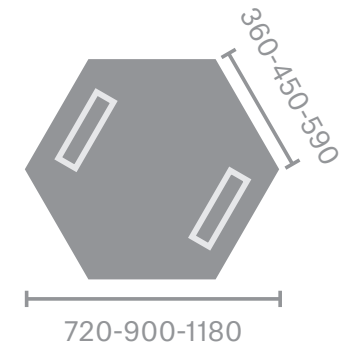



Quiet Acabados

Colores estandarizados

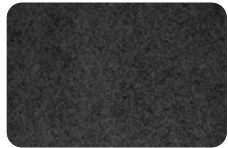

K05 Charcoal



Z04 Light Camel



E38 Eucalyptus Green

Personalización



Troquelados



Biselados



Impresiones

Más colores disponibles

Essential Colours



Z07 White



Z92 Natural Almond



Z04 Light Camel



Z12 Dark Camel



Z98 Slate Green



E38 Eucalyptus Green



K14 Lake Blue



Z14 Light Blue



Z19 Navy Blue

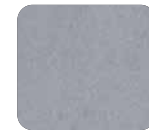

Z30 Water Grey



K13 Black



K05 Charcoal



Z11 Marble Grey



Z05 Apricot



Z46 Orange



Z08 Crimson



Z24 Burdeaux



E87 Light Salmon

Prime Colours



A101 Marble Light



A202 Pale Brown



A027 Light Green



A220 Mint Green



A099 Aqua



A224 Malachite Blue



A222 Dark Turquoise



A208 Blue Haze



A227 Lotus Blue

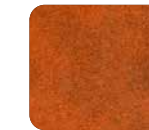

A226 Sunset

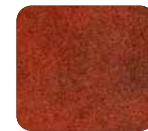

A219 Rust Red



A206 Litmus Red



A026 Lilacy



A029 Taro Purple

QUIET ACABADOS

Más colores disponibles

Trendy Colours

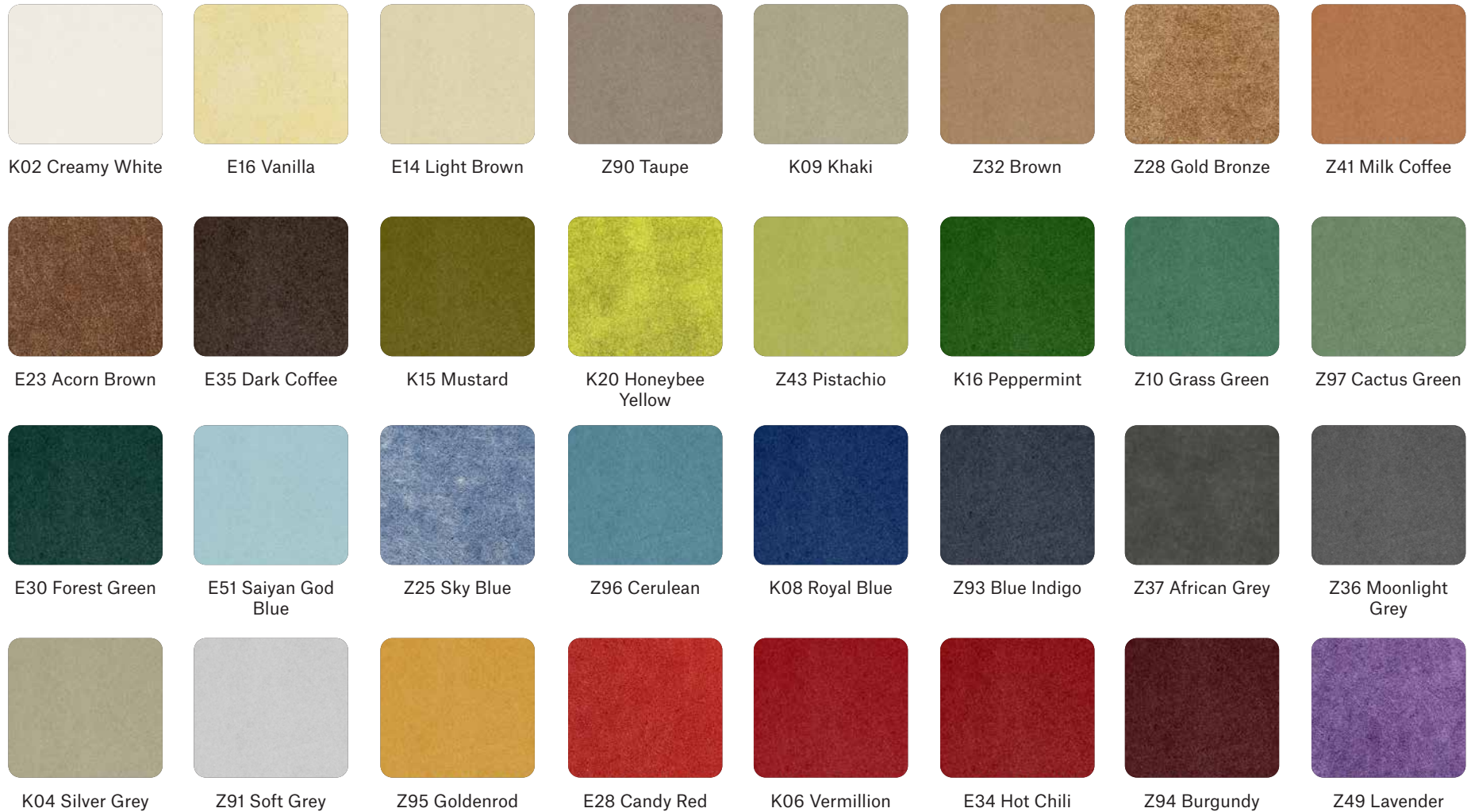

HANCE BIOPHILIA

Design by Lamp





Diseño biofílico

~ *Biophilia: tendencia psicológica a sentirse atraído por todo lo vivo y vital* ~

El diseño biofílico, trata de fomentar la conexión innata entre el ser humano y la naturaleza dentro del proyecto, ayudando a crear espacios más saludables y confortables, a través de la integración de elementos orgánicos y materiales naturales. Práctica que recoge algunos estándares especializados en la generación de espacios saludables.

Beneficios de los jardines verticales

- **Purificación del aire.** Eliminando hasta un 85% de los agentes tóxicos del aire, como Benceno, Formaldehídos y tricloroetileno.
- **Aislamiento Térmico.** Reduciendo las temperaturas en época de calor y manteniendo el caso interior en épocas de frío.
- **Aislamiento Acústico.** Absorbe hasta 10 dB del ruido ambiental.
- **Mejora la sensación de bienestar y confort en los usuarios,** colabora en crear paisajes urbanos más verdes, teniendo impactos positivos en la biodiversidad, el cambio climático y mitigando el efecto de isla de calor de las ciudades.





Espectro lumínico optimizado para iluminación de vegetación.

- Distribución lumínica “Full Spectrum”
- CRI hasta 85
- CCT (aproximada) 2700K
- Opción de iluminación para “Crecimiento Vegetativo” o “Crecimiento Generativo (Floración)”
- Flujo: Hasta 177 $\mu\text{mol/s}^*$
- Eficiencia: 2.7 $\mu\text{mol/J}^*$
- Distribución luminosa: FL (37°), MFL(24°), Elíptica

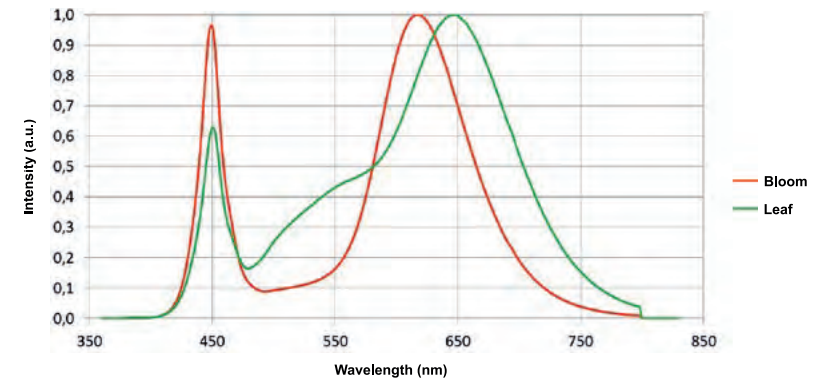

*Datos de la fuente de luz



OTRAS LUMINARIAS DISPONIBLES

Consulta otros modelos compatibles con la iluminación de ecosistemas vegetales, como luminarias lineales o de grandes alturas.

HANCE
DOWNLIGHT

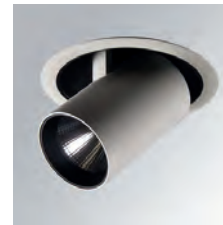

KOMBIC



STORMBELL



IMAG



FIL





Hance Downlight

"Infinitas posibilidades"

Alto rendimiento, estilo sofisticado y versatilidad en una solución de iluminación empotrada que supera tus expectativas. Diseño basado en la flexibilidad dentro de los espacios retail, nace una nueva familia de iluminación de acento que se caracteriza por su amplitud de gama y aplicación.

Design by Lamp





Soluciones para empotrar de alto flujo

Downlights diseñados en una variedad de tamaños y flujos luminosos, desde 975 lm hasta 4,100 lm reales.

- **Modelo integrado**
Con una rotación de 355° e inclinación de 0° a 30°, para aplicaciones dónde el producto pasa desapercibido y se busca una máxima integración en el espacio.
- **Modelo semi-empotrado**
Con una rotación de 355° e inclinación de 0° a 85°, para aplicaciones con mayores requerimientos de direccionamiento de la luz. Soluciona la iluminación de estanterías dónde se requiere uniformidad en todo el plano vertical.



Alta eficiencia y variedad de opciones lumínicas

- Máxima eficiencia energética, de hasta 127lm/W.
- Disponible en diferentes temperaturas de color, (3000-4000K) y alta reproducción cromática (CRI90), ofrece gran variedad de ángulos de apertura para adaptarse a las necesidades de iluminación: súper spot (10°), spot (20°), medium flood (25°) y flood (35°).



Variedad de acabados y accesorios adicionales

Aros intercambiables y personalizables que permiten incorporar varios accesorios ópticos de forma integrada y adaptarse a los requerimientos lumínicos con coherencia y sentido en el espacio.

Acabados: El cuerpo disponible en dos acabados estándar: negro y blanco, incorporando un aro anti-deslumbramiento negro, disponible también en metalizado cobre, plata y blanco.

Amplia gama de accesorios lumínicos: lentes elípticas, lentes soft, rejillas antideslumbrantes honeycomb y recortadores.

Hance Downlight | Indoor



+ INFORMACIÓN TÉCNICA

Ind.



Modelos	REC 1000/2000	SEMI-REC 1000/2000	REC 3000/4000	SEMI-REC 3000/4000
Dimensiones				
Lm LED	1000 lm - 2000 lm		3000 lm - 4000 lm	
IRC	80 / 90			
Ángulos apertura				
Temp. Color	2700 / 3000 / 4000 K			
Equipo	ON/OFF - DALI			
Potencia	7 - 18 W		25 - 35 W	
Acabados	● Negro 03	○ Blanco 03		
Acabados Acc.	● Negro 03	○ Blanco 03	● Metalizado Plata	● Metalizado Cobre

Hance Downlight | Indoor



+ INFORMACIÓN TÉCNICA

Ind.



Recessed

1000 / 2000 Lm LED - 64 models

3000 / 4000 Lm LED - 48 models

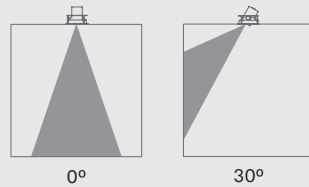
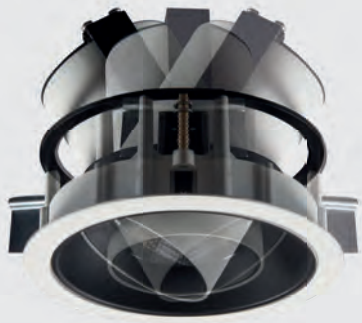

Con una rotación de 0° a 30°, para aplicaciones dónde el producto pasa desapercibido y se busca una máxima integración en el espacio.

Semi-Recessed

1000 / 2000 Lm LED - 64 models

3000 / 4000 Lm LED - 48 models

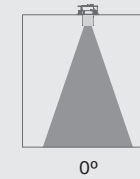
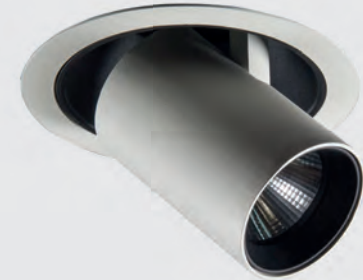
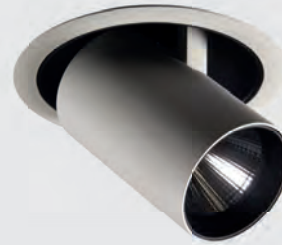

Con una rotación de 0° a 85°, para aplicaciones con mayores requerimientos de direccionamiento de la luz. Soluciona la iluminación de estanterías dónde se requiere uniformidad en todo el plano vertical.





Hance Spotlight

"Infinitas posibilidades"

Diseñado con la flexibilidad en mente, Hance Spotlight es la elección perfecta para iluminar espacios de retail y exposición. Con un rendimiento mejorado de 127lm/W, esta familia de iluminación de acento destaca por su versatilidad y aplicabilidad en diversos entornos. Estamos comprometidos con la innovación tecnológica y miramos hacia un horizonte infinito de posibilidades.

Design by Lamp

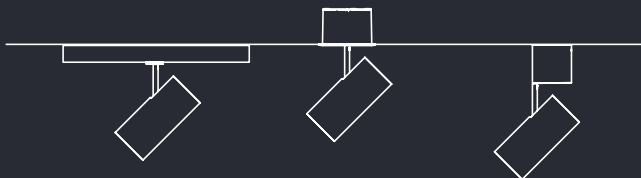



Diseño adaptable

Nuestros proyectores spotlight están disponibles en tres opciones de instalación: **carril, superficie o semi-empotrado, (rotación 355° e inclinación de 0° a 90°)** brindando versatilidad en su instalación. Además, la familia esta complementada con sus versiones downlight.

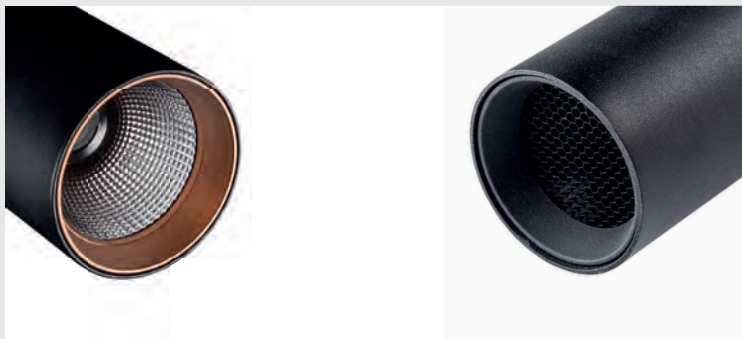

Variedad de acabados y accesorios

Acabados: El cuerpo está disponible en dos acabados estándar elegantes: negro y blanco texturizados, incorporando un aro antideslumbramiento negro, disponible también en metalizado cobre, plata y blanco.

Amplia gama de accesorios lumínicos: lentes elípticas, lentes soft, rejillas antideslumbrantes honeycomb y recortadores.

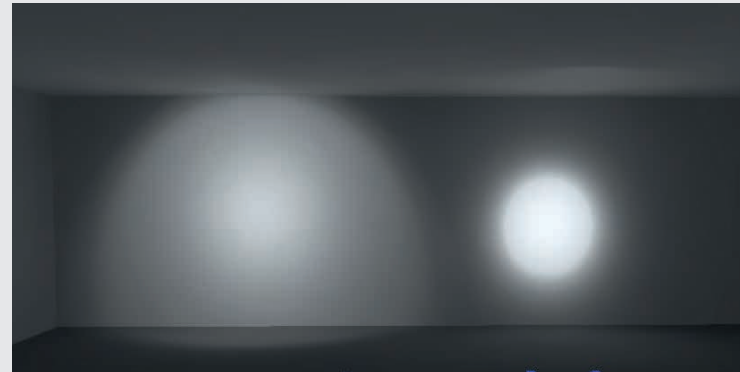

Alta eficiencia y variedad de opciones lumínicas

- Máxima eficiencia energética, de hasta 127lm/W.
- Disponible en diferentes temperaturas de color, (3000-4000K) y alta reproducción cromática (CRI80-90), ofrece gran variedad de ángulos de apertura para adaptarse a las necesidades de iluminación: súper spot (10°), spot (20°), medium flood (25°) y flood (35°).



Integración con el espacio

Modelos con instalación a carril de 48V que buscan la máxima integración en el espacio con un diseño miniaturizado y poco intrusivo con el entorno.

Hance Spotlight | Indoor



+ INFORMACIÓN TÉCNICA

Ind.



Modelos	1000	2000	3000	4000
Dimensiones Track				
Dimensiones Surface Semi-Recessed				
Lm LED	1000 lm	2000 lm	3000 lm	4000 lm
IRC	80 / 90			
Ángulos apertura	SSP 10° SP 16°-17° MFL 23°-24° FL 36°-37°	SP 16° MFL 23° FL 34°		
Temp. Color	3000 / 4000 K			
Equipo	ON/OFF - DALI			
Potencia	7 W	18 W	25 W	35 W
Acabados	● Negro 03 ○ Blanco 03			
Acabados Acc.	● Negro	○ Blanco	● Metalizado Plata	● Metalizado Cobre



Hance 1000 Lm





+ INFORMACIÓN TÉCNICA

Ind.



Hance Spotlight Family

HANCE TRACK



HANCE SURFACE

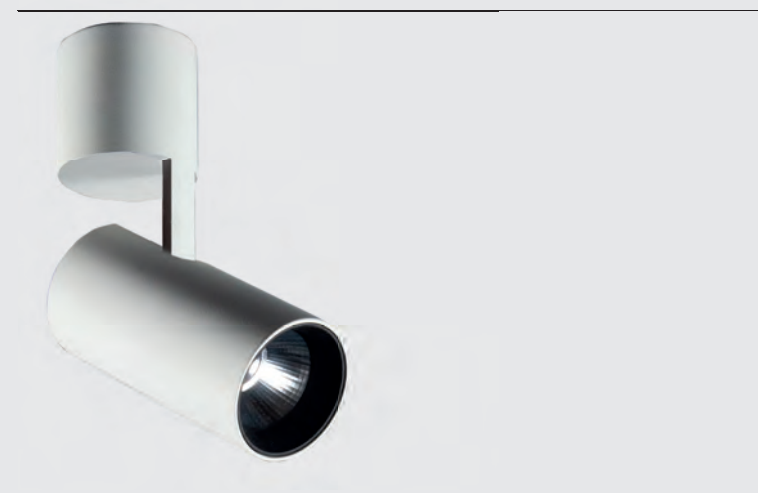

HANCE SEMI-RECESSED





+ INFORMACIÓN TÉCNICA

Ind.

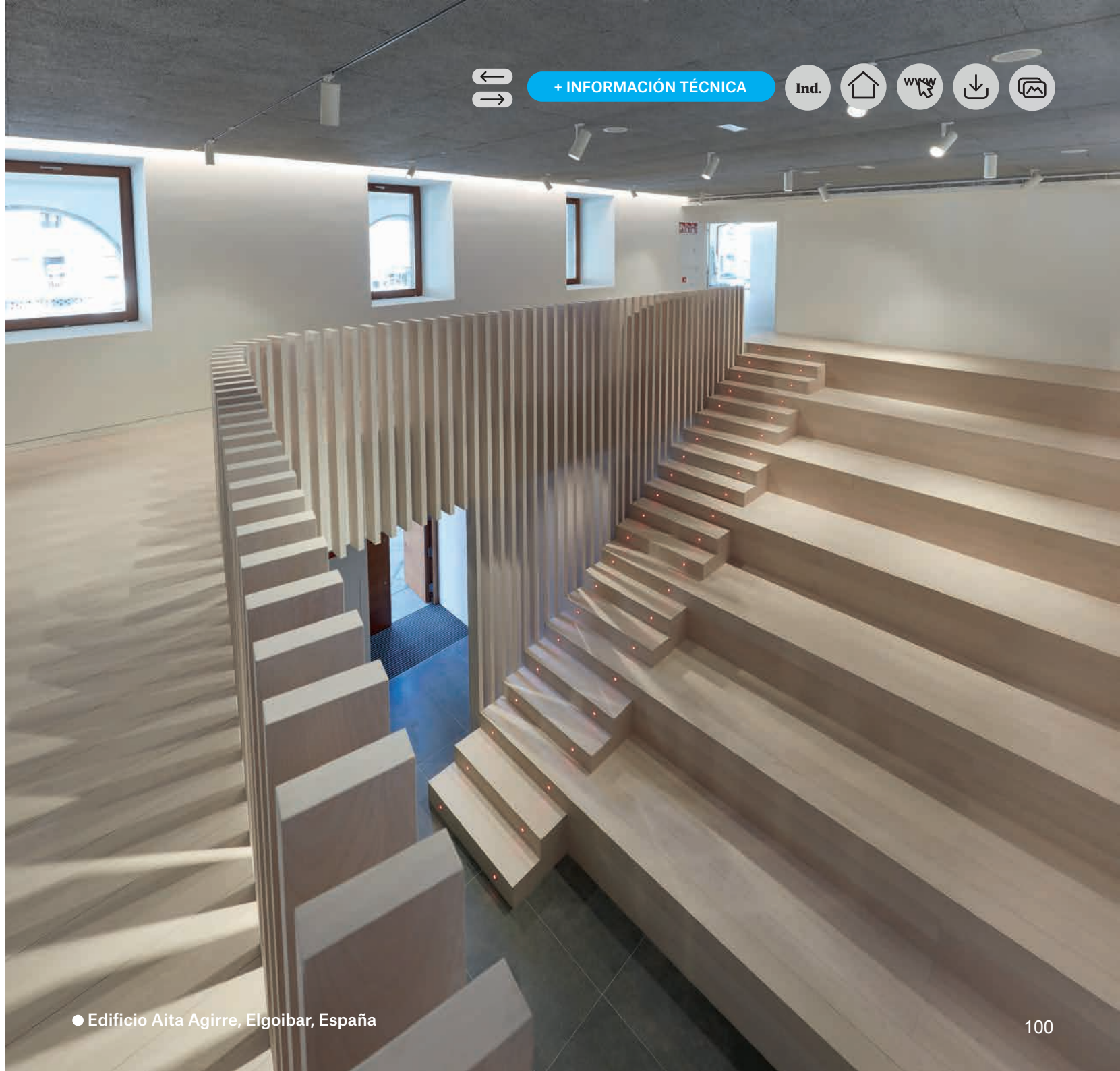

Hance 48V

“La importancia de los detalles”

La miniaturización de este proyector tiene un papel clave dentro de la familia Hance, siendo un producto de cercanía para el usuario que cuida los detalles asegurando su total integración en los espacios más exigentes a través de una amplia gama que permite jugar con sus acabados.

Design by Lamp

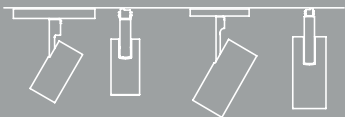



+ INFORMACIÓN TÉCNICA

Ind.



LM LED
1000 - 2000
96 models ●
48V Track

LM LED
500
36 models ●
48V Track

Aplicaciones

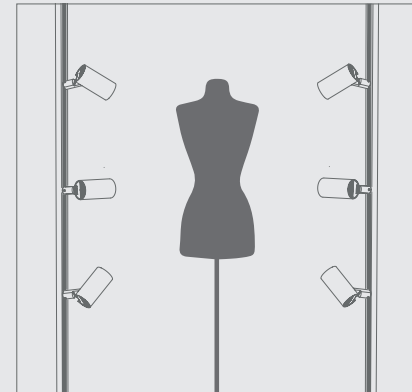

Escaparates tienda

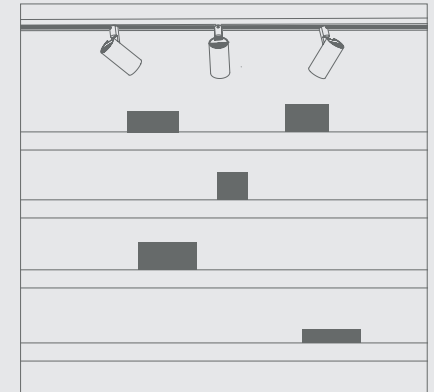

Estanterías

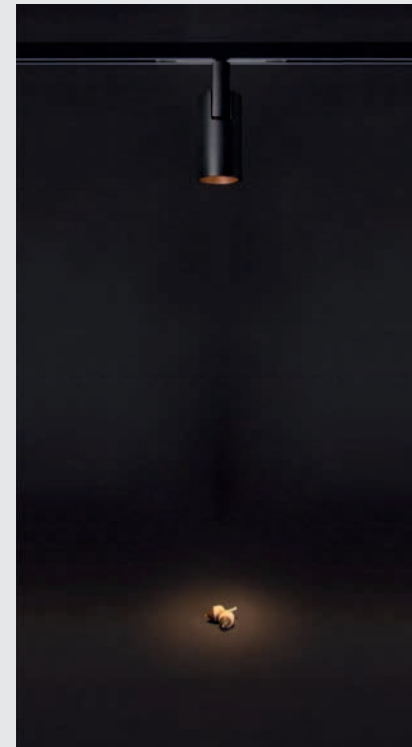



+ INFORMACIÓN TÉCNICA

Ind.



Modelos

500



1000/2000



Dimensiones

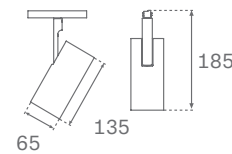
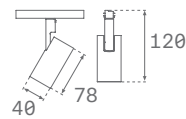

Lm LED

500 lm

1000 lm - 2000 lm

IRC

80

Ángulos apertura

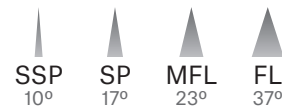

Temp. Color

2700 / 3000 / 4000 K

Equipo

ON/OFF - DALI

Potencia

5 W

8 - 18 W

Acabados

● Negro 03 ○ Blanco 03

Acabados Acc.

● Negro ○ Blanco ● Metalizado Plata ● Metalizado Cobre

Hance 48V



+ INFORMACIÓN TÉCNICA

Ind.



Lamp Worktitude for light

● Restaurante Croma by Flash, Barcelona, España

Ocult Downlight

“Versatilidad lumínica con el máximo confort”

Partiendo del confort visual como premisa de diseño, surge una tipología de downlight modular que, bajo una mínima expresión formal, ofrece una gran versatilidad lumínica, pudiendo elegir entre iluminación de acento o general, así como entre una extensa variedad de longitudes, configuraciones modulares y acabados.

Design by Lamp

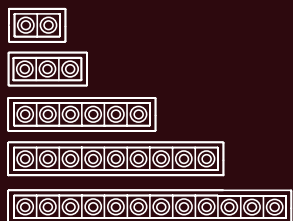

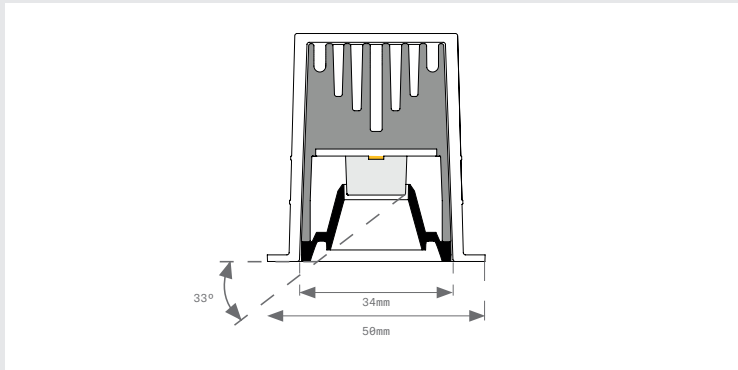

Alto confort visual

El diseño óptico se realiza mediante una lente y un cut off de 33°, y permite ofrecer un alto confort visual con un UGR <19 o <15 (para 4H,8H 70/50/20) según la óptica.

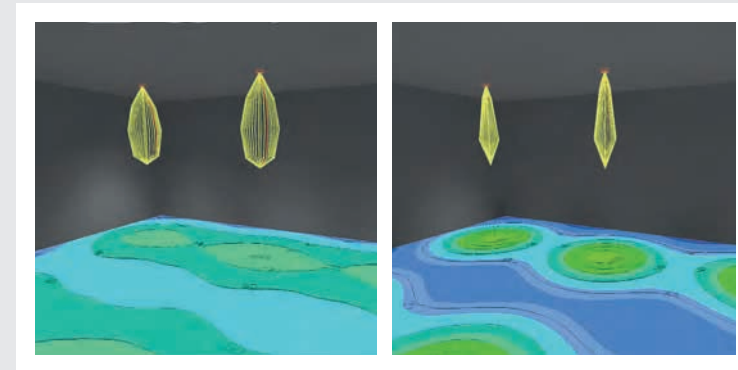

Versatilidad de aplicaciones lumínicas

Gracias a su amplio rango de flujos y aberturas: MFL (24°) y WFL (48°), es posible su utilización tanto para espacios de iluminación general donde se quiera realizar una luz uniforme, como para espacios de hospitality donde se quieran generar contrastes de luz.



Vinculación con el interiorismo

El sistema intercambiable de embellecedores frontales nos permite conectar la estética de la luz con el contexto, y ofrece soluciones trimless para un menor impacto en el espacio.

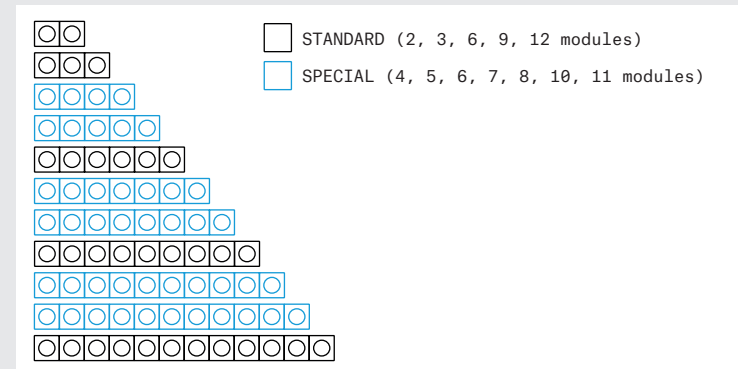

Longitud customizable

Su concepción técnica nos permite customizar su longitud para adaptarnos mejor a las necesidades específicas de cada proyecto.



+ INFORMACIÓN TÉCNICA

Ind.



Modelos	2 MODULES	3 MODULES	6 MODULES	9 MODULES	12 MODULES
Dimensiones Frame					
Dimensiones Trimless					
Lm LED	400 lm	600 lm	1200 lm	1800 lm	2400 lm
IRC	80				
Ángulos apertura					
Temp. Color	3000 / 4000 K				
Equipo	ON/OFF - DALI				
Potencia	4 W	6 W	12 W	18 W	24 W
Acabados	● Negro 03 ○ Blanco 03				
Acabados Acc.	○ Blanco 03	● Metalizado Plata	● Metalizado Cobre		



+ INFORMACIÓN TÉCNICA

Ind.



Marco de instalación



Cuerpo disipador de extrusión
Permite modularidad



PCB con HI-POWER LED

3000K - CRI80
4000K - CRI80

Ópticas



Reflector de alto confort visual

- Blanco
- Negro
- Metalizado Plata
- Metalizado Cobre

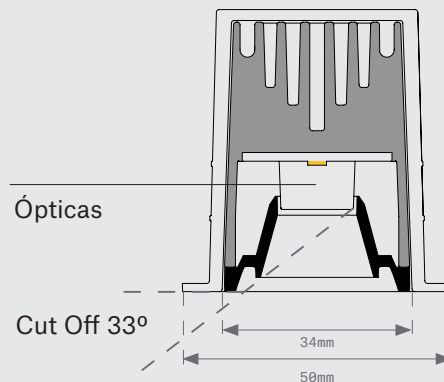



+ INFORMACIÓN TÉCNICA

Ind.



Instalación

Con marco

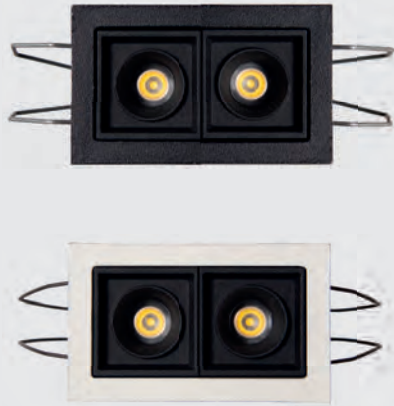

Trimless



Acabados

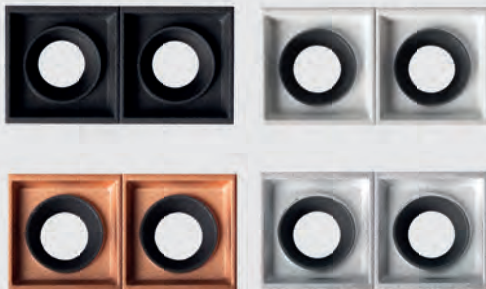

Modulación





Ocult System

“Imagina la solución, nosotros la haremos realidad”

Las múltiples necesidades que pueden surgir en un espacio versátil y polivalente resueltas de una forma tan sencilla como elegante: un sistema que permite crear iluminación de acento o iluminación general gracias a la integración de downlight modulares, luminarias suspendidas, o proyectores. Imagina la solución, nosotros la haremos realidad.

Design by Lamp

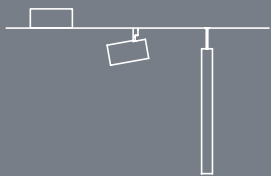



+ INFORMACIÓN TÉCNICA

Ind.



Configuración



Configurador web

1. Instalación

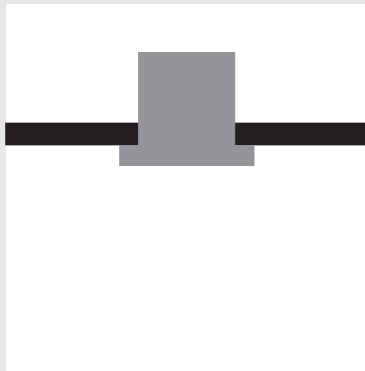

Empotrado

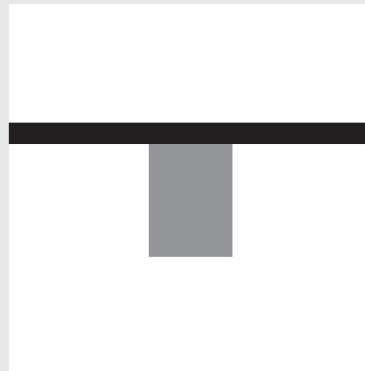

Superfici

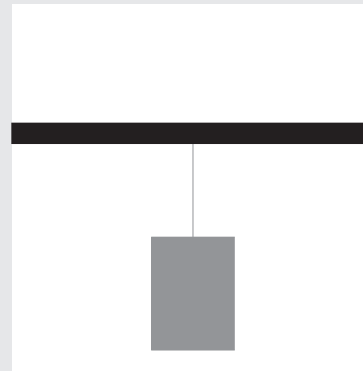

Suspendido

2. Formato



Lineal

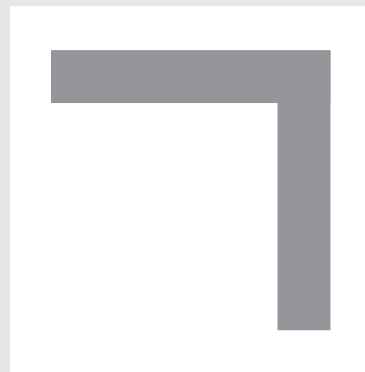

Corner

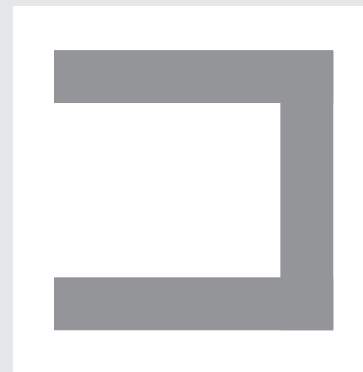

Formato U

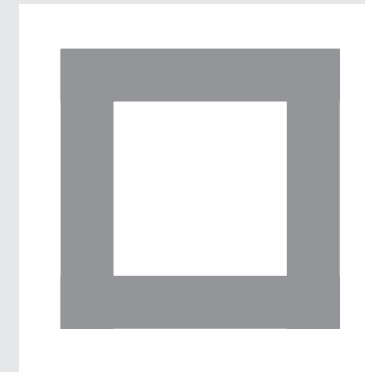

Cuadrado



Personalizado



+ INFORMACIÓN TÉCNICA

Ind.



3. Modulos Lumínicos

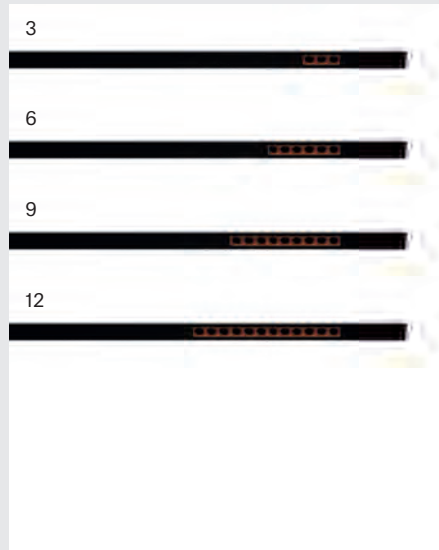

Downlight



Proyector



Pendular

4. Accesorios

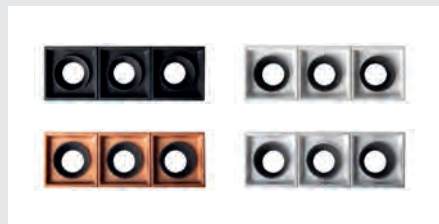

Downlight

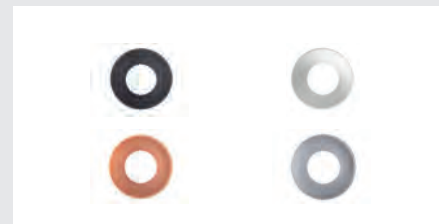

Proyector

5. Solución

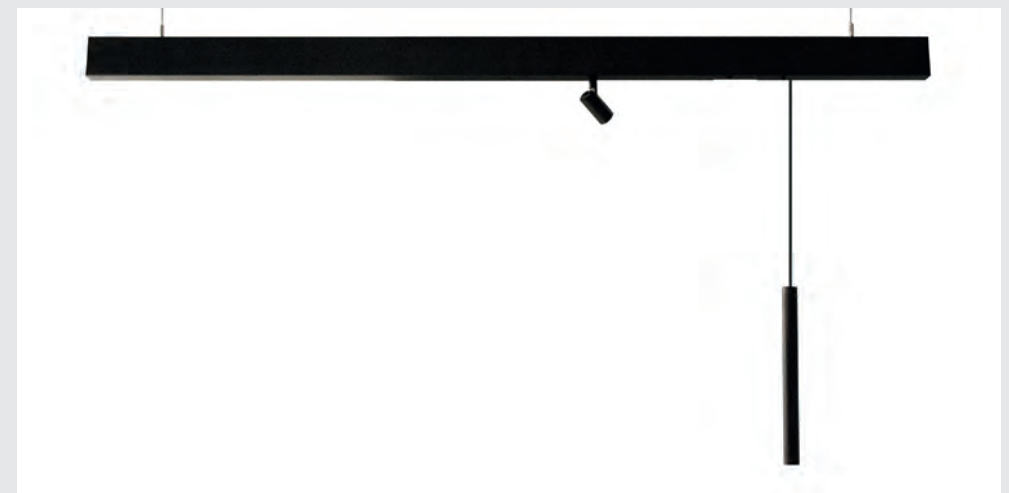



Versatilidad aplicaciones

Ofrece soluciones para planos verticales y horizontales dentro del mismo sistema, con soluciones de acentuación, luz general y suspensión.



Tapa retráctil

La doble altura de la tapa permite una mejor integración de los elementos en el perfil, y la reducción del impacto del producto dentro del espacio.



Coherencia formal

Todos los elementos del sistema se integran con su formato cilíndrico y miniaturizado dentro de una misma coherencia formal y con accesorios decorativos con distintos acabados que permiten su personalización.



+ INFORMACIÓN TÉCNICA

Ind.



Modelos

DOWNLIGHT



SPOTLIGHT 500



SPOTLIGHT 1000



PENDULAR



Dimensiones

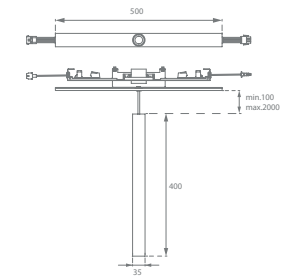
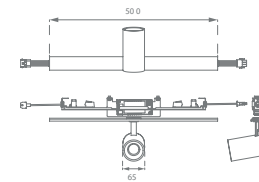
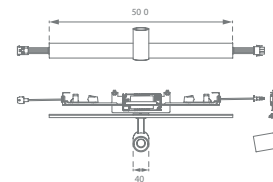
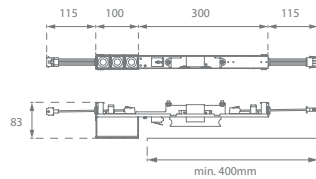

Lm LED

600 lm - 2400 lm

500 lm

500 lm - 1000 lm

500 lm

IRC

80

Ángulos apertura

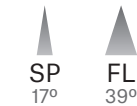
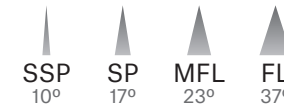

Temp. Color

3000 / 4000 K

Equipo

ON/OFF - DALI

Potencia

6 - 24 W

5 W

8 - 9 W

4 W

Acabados

● Negro 02

Acabados Acc.

● Negro 02

○ Blanco 02

● Metalizado Plata

● Metalizado Cobre

● Negro 03

○ Blanco 05

Ocult System

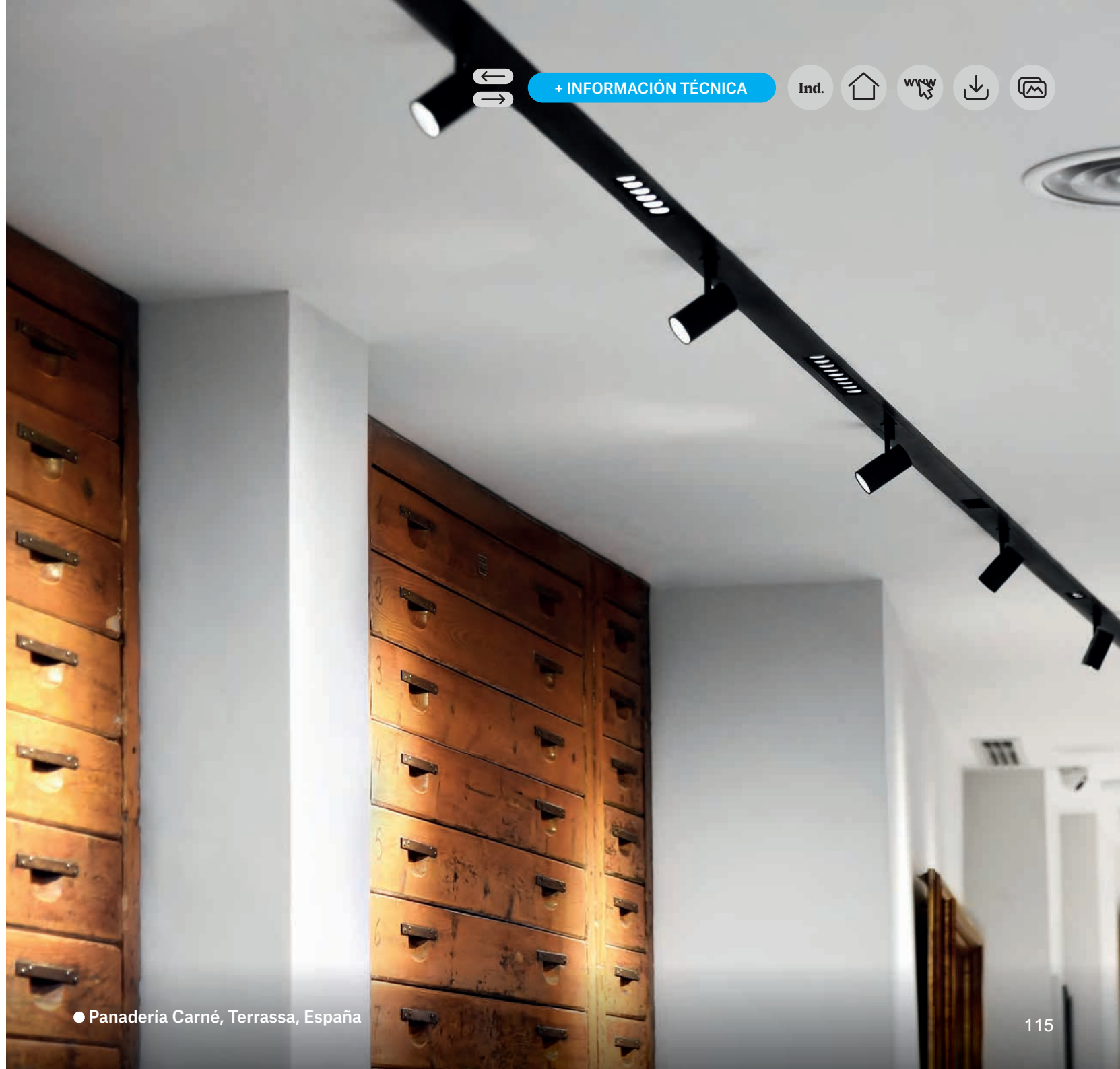

+ INFORMACIÓN TÉCNICA

Ind.





Imag

“Funcionalidad y tecnología”

A partir de un diseño neutro, Imag combina todas las mejoras tecnológicas y prestaciones de sus mejores antecesores. Se trata de un producto en constante evolución técnica.

Design by Lamp

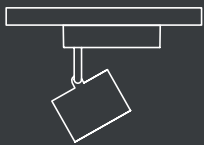



+ INFORMACIÓN TÉCNICA

Ind.



Modelos

TRACK



Dimensiones

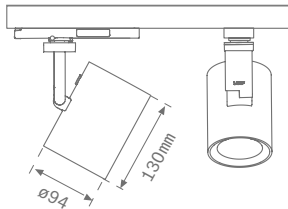

Lm LED	2000 lm - 4000 lm
IRC	90
Ángulos apertura	<p>SP 15°-20° MFL 22°-26° FL 33°-36° WFL 56°-57°</p>
Temp. Color	3000 / 4000 K
Equipo	ON/OFF
Potencia	14 - 37 W
Acabados	● Negro 05 ○ Blanco 05



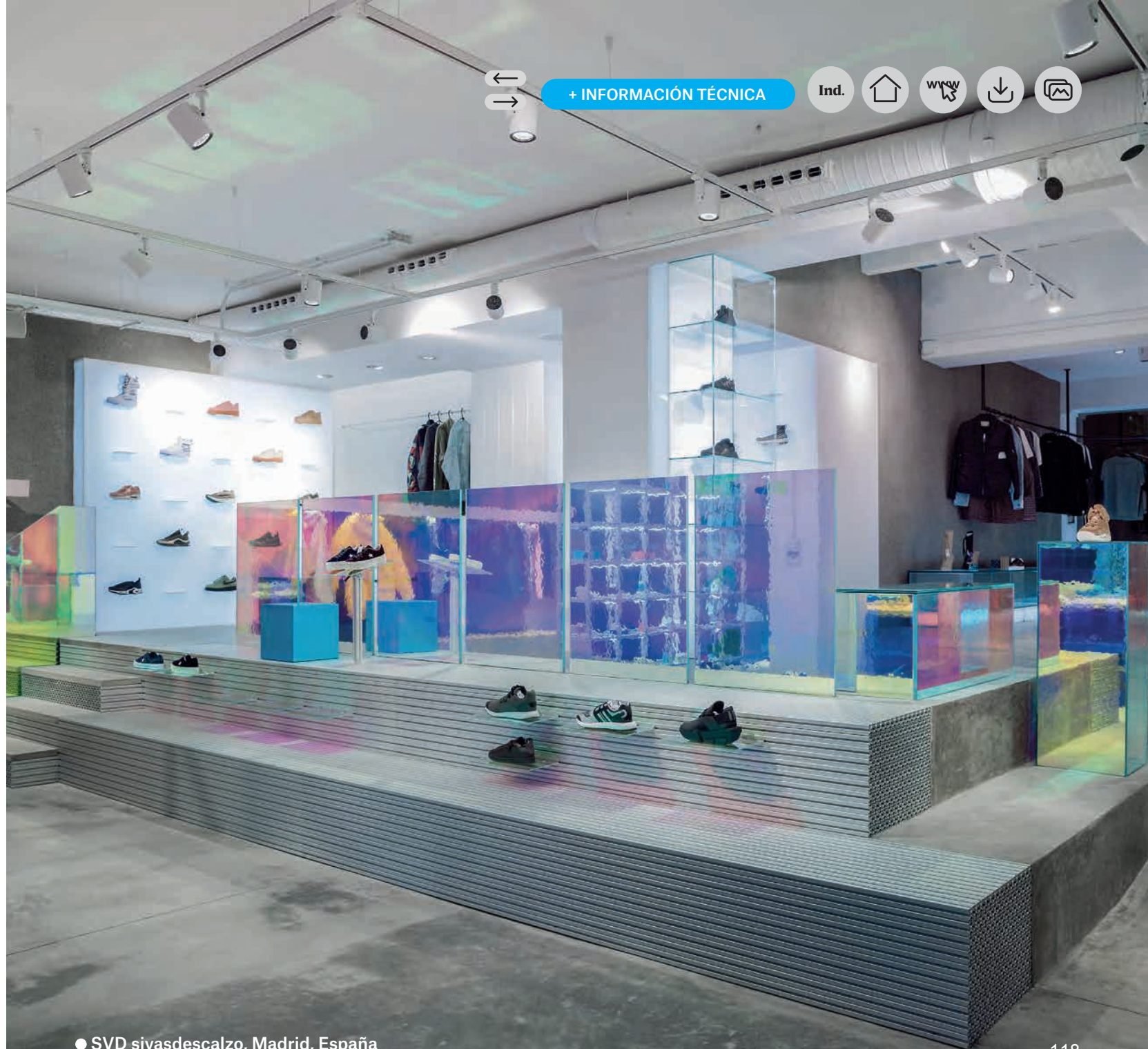

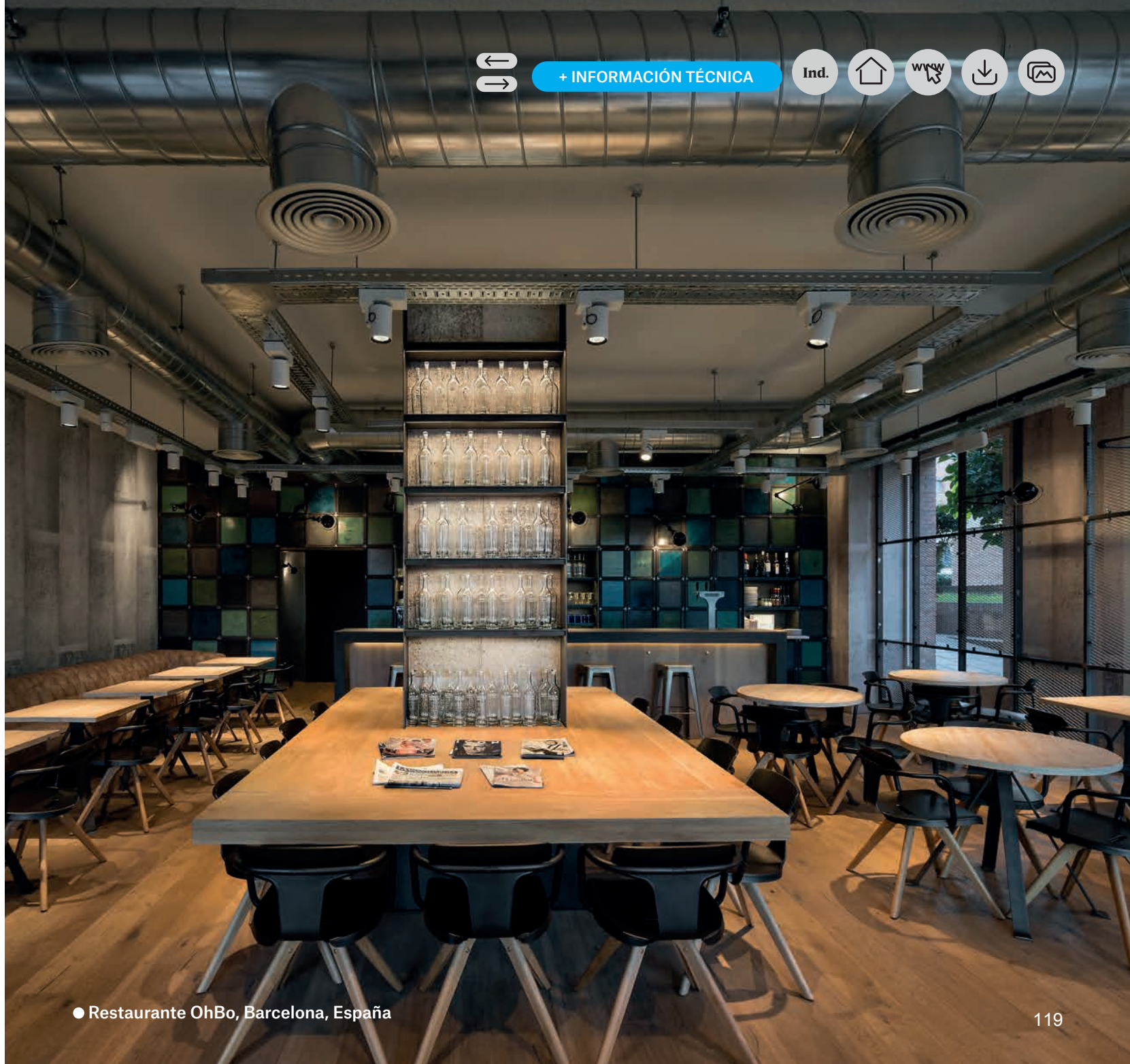

+ INFORMACIÓN TÉCNICA





Ind.

Kombic

“Versatilidad lumínica y alto confort visual bajo un diseño compacto”

Kombic renace bajo un nuevo diseño transformándose en una familia más versátil. Bajo un diseño compacto ofrece múltiples opciones de instalación y acabados, así como una extensa variedad de flujos lumínicos y prestaciones ópticas.

Design by Lamp

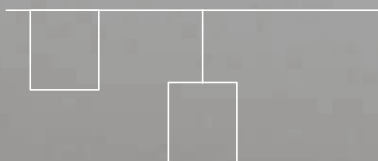



+ INFORMACIÓN TÉCNICA

Ind.



Kombic 70

Downlight



Surface



Kombic 100

Downlight



Surface



Kombic 150

Downlight



Surface



Kombic 200

Downlight



Surface



Óptica

Basic **Comfort** **Efficiency**

Opal 54° Optic WF 52° Elliptic Wall Washer (WW) RF 33° RW 52°



Óptica

Basic **Comfort** **Efficiency**

Opal 67° Optic WF 52° Elliptic Wall Washer (WW) RF 33° RW 60°

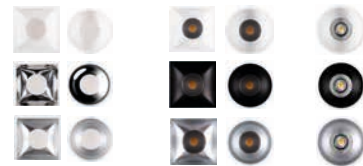

Óptica

Basic **Comfort** **Efficiency**

Opal 66° Optic WF 61° Elliptic Wall Washer (WW) RF 33° RW 60°



Óptica

Basic

Opal 66°



Acabados



Ver acabados downlight & surface

Acabados



Ver acabados downlight & surface

Acabados



Acabados





+ INFORMACIÓN TÉCNICA

Ind.

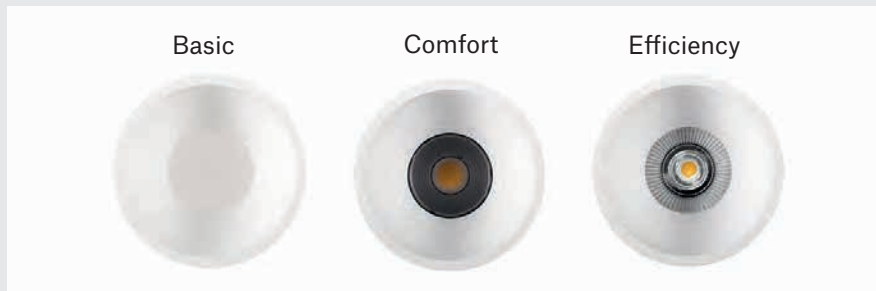

Tres versiones incorporadas en una solución única para resolver múltiples aplicaciones:

Basic: Modelo Opal, para iluminación general.

Comfort: Modelo con ópticas, UGR<16 y eficiencia de hasta 107,60 lm output/W .

Efficiency: Modelo con reflector, diferentes aperturas. UGR<19, y eficiencias de hasta 130 lm output/W.



Versatilidad de aplicaciones: posibilidad de instalación empotrada, superficie, suspendida y versión nomadic system (adaptación a carril electrificado).



Reflector fabricado en policarbonato reciclado R-PC FR WHITE™ con retardante de llama libre de bromo. Grado inflamabilidad V0 según UL94.

Declaraciones ambientales basadas en la norma UNE 15804, lo que cuantifica su **impacto en la huella de carbono** a lo largo de su ciclo de vida.

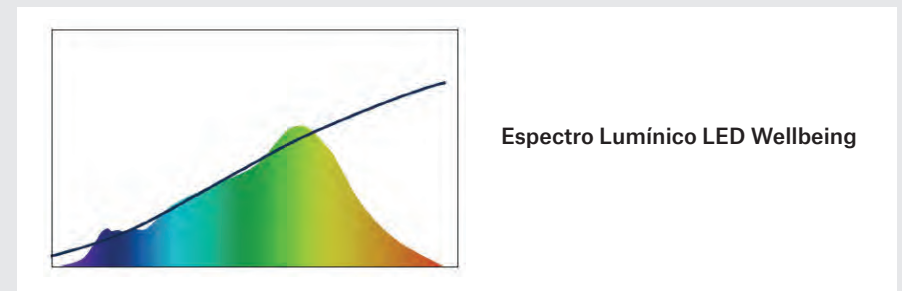

Iluminación dinámica Wellbeing, entre una gran variedad de tecnologías disponibles.



Nuevas ópticas Elíptica y Wallwasher para la familia:

Óptica Elíptica que optimiza la distribución de luz. Esta luminaria permite aumentar la distancia entre luminarias, reduciendo el efecto de luz residual en las paredes. Ideal para iluminar zonas de paso, áreas longitudinales como mostradores y espacios adyacentes a áreas de trabajo.

Disponibile para Kombic 70, 100 y 150.

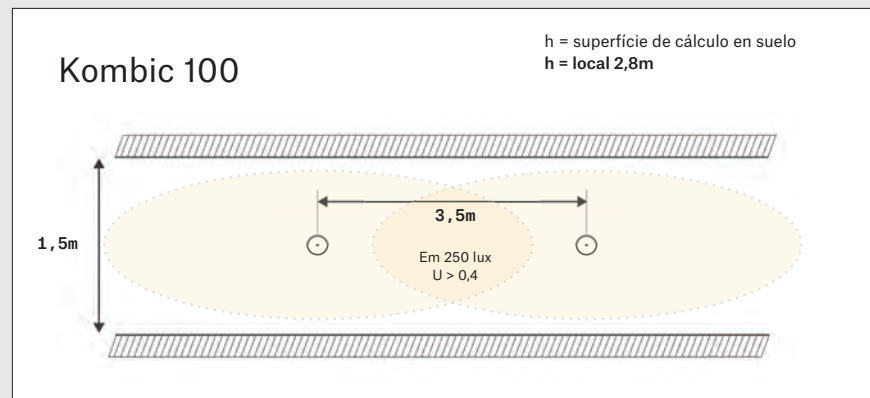
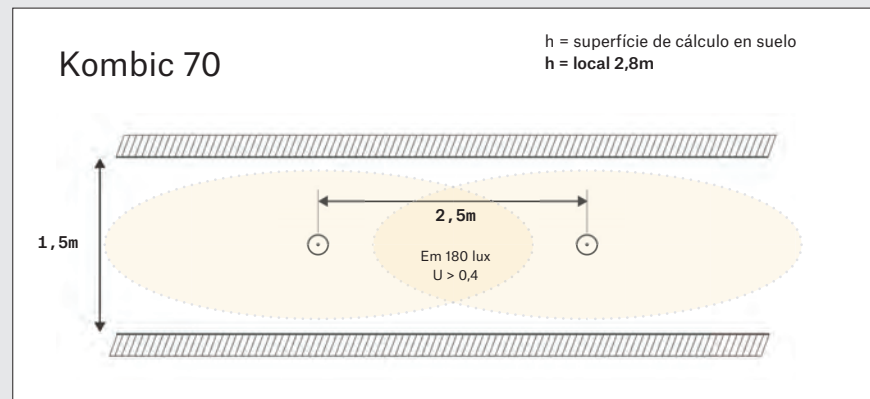

Ejemplos esquema de instalación recomendada en zonas de paso

Óptica Wallwasher para un control de la distribución lumínica hacia la superficie vertical sin zonas oscuras.

Disponibile para Kombic 70, 100 y 150.

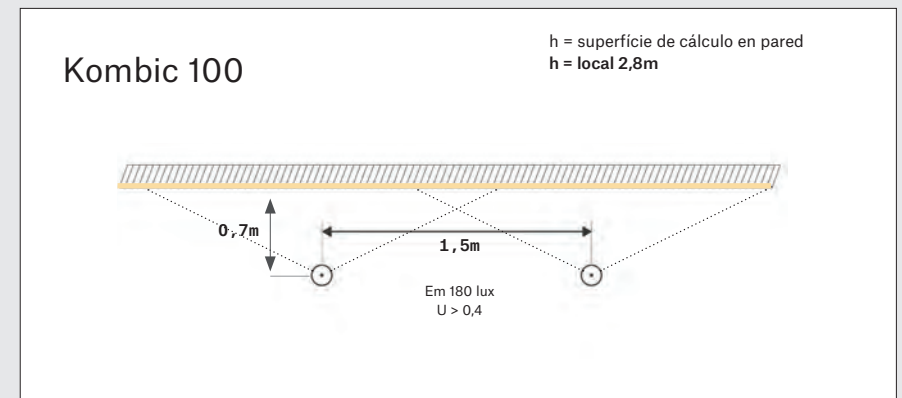
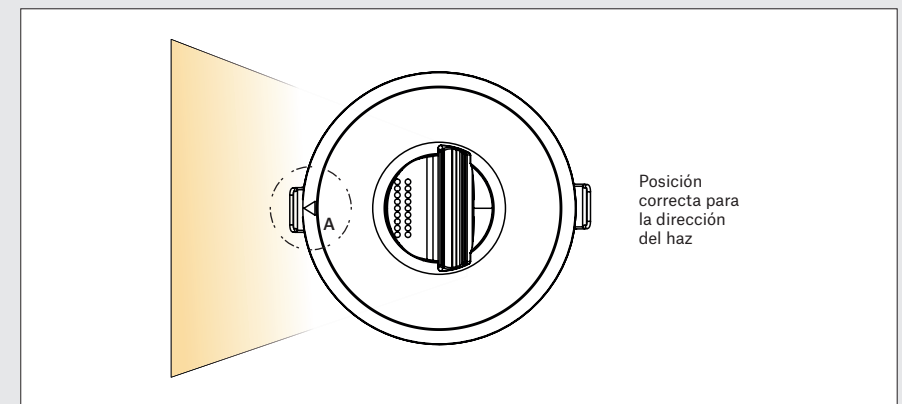

Ejemplos esquema de instalación recomendada en zonas de paso



+ INFORMACIÓN TÉCNICA

Ind.



Modelos	DOWNLIGHT 70	DOWNLIGHT 100	DOWNLIGHT 150	DOWNLIGHT 200	SURFACE 70	SURFACE 100	SURFACE 150	SURFACE 200
Dimensiones								
Lm LED	1500lm	2000-2500lm	2000-3500lm	3000-5000lm	1500lm	2000-2500lm	2000-2500lm	3000-5000lm
IP	BASIC IP43 IP44 IP65 COMFORT & EFFICIENCY IP43	BASIC IP43 IP44 IP65 COMFORT & EFFICIENCY IP43	BASIC IP43 IP44 IP65 COMFORT & EFFICIENCY IP43	BASIC IP43 IP44 IP65 COMFORT & EFFICIENCY IP43	BASIC IP20 COMFORT & EFFICIENCY IP43	BASIC IP43 IP44 IP65 COMFORT & EFFICIENCY IP43	BASIC IP43 IP44 IP65 COMFORT & EFFICIENCY IP43	BASIC IP43 IP44 IP65 COMFORT & EFFICIENCY IP43
IRC / CRI	80-90	80-90	80-90	80-90	80-90	80-90	80-90	80-90
Ángulos apertura			OPAL	OPTIC	ELLIPTIC	WALLWASHER	REFLECTOR	
Temp.color	2700-3000-4000K	2700-3000-4000K Tunable White Wellbeing	2700-3000-4000K Tunable White Wellbeing	3000-4000K	2700-3000-4000K	2700-3000-4000K Tunable White Wellbeing	2700-3000-4000K Tunable White Wellbeing	3000-4000K
Equipo	ON-OFF / DALI							
Potencia	8,4W	12-18W	12-25W	17-36W	9,5W	12-18W	12-25W	17-36W
Acabados	○ ●							



KOMBIC 70 DOWNLIGHT

Exigencia técnica y adaptabilidad lumínica en un volumen compacto

Downlight con un exigente comportamiento técnico para dar respuesta a diferentes requerimientos lumínicos, a través de un volumen miniaturizado y compacto.

Design by Lamp



+ INFORMACIÓN TÉCNICA

Ind.



Kombic 70 Downlight





Downlight con un exigente comportamiento técnico para dar respuesta a diferentes requerimientos lumínicos, a través de un volumen miniaturizado y compacto.

Principales segmentos de aplicación:

**OFFICE/
EDUCATION**
Comfort
Eficiencia

**COMMON
SPACES**
Basic
Eficiencia

**HEALTHCARE
& WELLNESS**
Basic
Comfort

Tres versiones incorporadas en una solución única para resolver múltiples aplicaciones:

BASIC
Modelo Opal,
para iluminación
general.

COMFORT
Modelo con
ópticas (52°),
UGR <16 y
eficiencia de
hasta 107,60 lm
output/W.

EFFICIENCY
Modelo con
reflector,
aperturas (52° y
33°), UGR <19,
eficiencias de
hasta 130 lm
output/W.

**Opción especial
de distribución
Spot (15°)*



+ INFORMACIÓN TÉCNICA

Ind.



MATERIALIDAD

Reducción del 96% de la huella de CO₂ en la fabricación gracias al uso de polycarbonato reciclado R-PC FR WHITE™ en el reflector.



EFICIENCIA

Hasta **130 lm output/W.**



CIRCULARIDAD

Concebido bajo criterio 3R:
Reducción de materiales: gracias a su miniaturización.
Reutilización: incorporando materiales reciclados de origen postindustrial.
Reciclable: concebido para mejorar su separabilidad y reciclabilidad al final de su ciclo de vida, y facilidad de mantenimiento.



DECLARACIONES AMBIENTALES DE PRODUCTO

En base UNE 15804. Cuantifica el impacto en la huella de carbono considerando toda la vida del producto. Facilitando la información para el ACV (Análisis de Ciclo de Vida) del edificio.



Lamp Worktitude for light



+ INFORMACIÓN TÉCNICA

Ind.



Confort y bienestar



SALUD VISUAL

Control del deslumbramiento activo a través de las versiones **COMFORT y EFFICIENCY**.

Luminarias “exenta de riesgo” RGO según la normativa de Riesgo Fotobiológico UNE 62471.



SALUD AMBIENTAL

Utilización de retardante de llama libre de bromo.

Polycarbonato R-PC FR WHITE™

Reflector fabricado en **polycarbonato reciclado R-PC FR WHITE™ con retardante de llama libre de bromo**. Grado de inflamabilidad V0 según UL94.

- Ahorro **70 Tn CO² Eq /año**
- Reducción **96 %** de la huella de CO₂ (por pieza)



+ INFORMACIÓN TÉCNICA



SOLID MATTE

White



Sand 2010-Y20R



METALLIC SHINE

Bronze



Champagne



Black

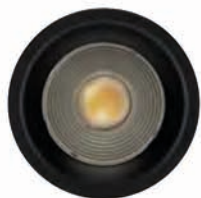

Dark Chocolate 8017

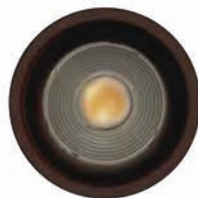

Terracotta 3009

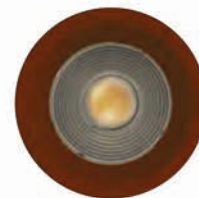

Dark Grey 7022





+ INFORMACIÓN TÉCNICA

Ind.



KOMBIC 70
Downlight



NUEVO

KOMBIC 70
Downlight

KOMBIC 70 SURFACE

Exigencia técnica y adaptabilidad lumínica en un volumen compacto

Luminaria con un exigente comportamiento técnico para dar respuesta a diferentes requerimientos lumínicos, a través de un volumen miniaturizado y compacto.

Design by Lamp



Kombic 70 Surface



+ INFORMACIÓN TÉCNICA

Ind.



Cuerpo

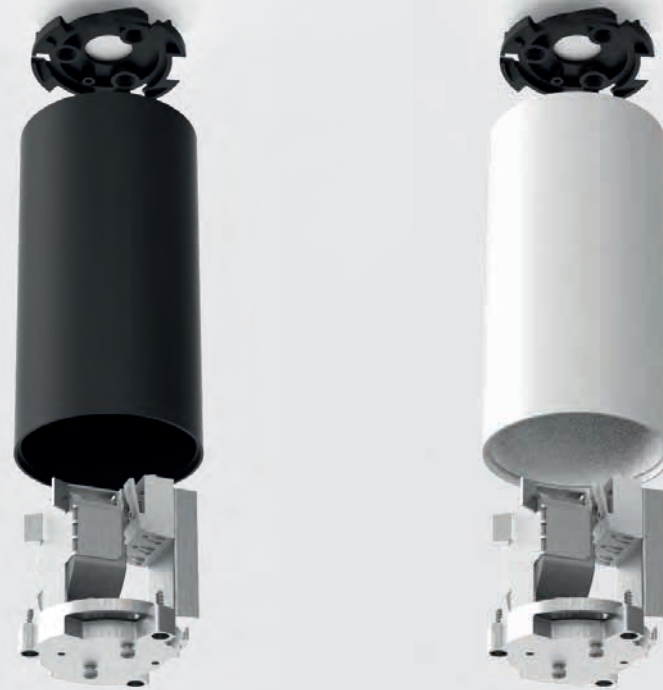

Basic
Opal 54°



Comfort
WF 52°



Efficiency
RF 33°
RW 52°

Reflector





+ INFORMACIÓN TÉCNICA

Ind.



KOMBIC 70
Short Track

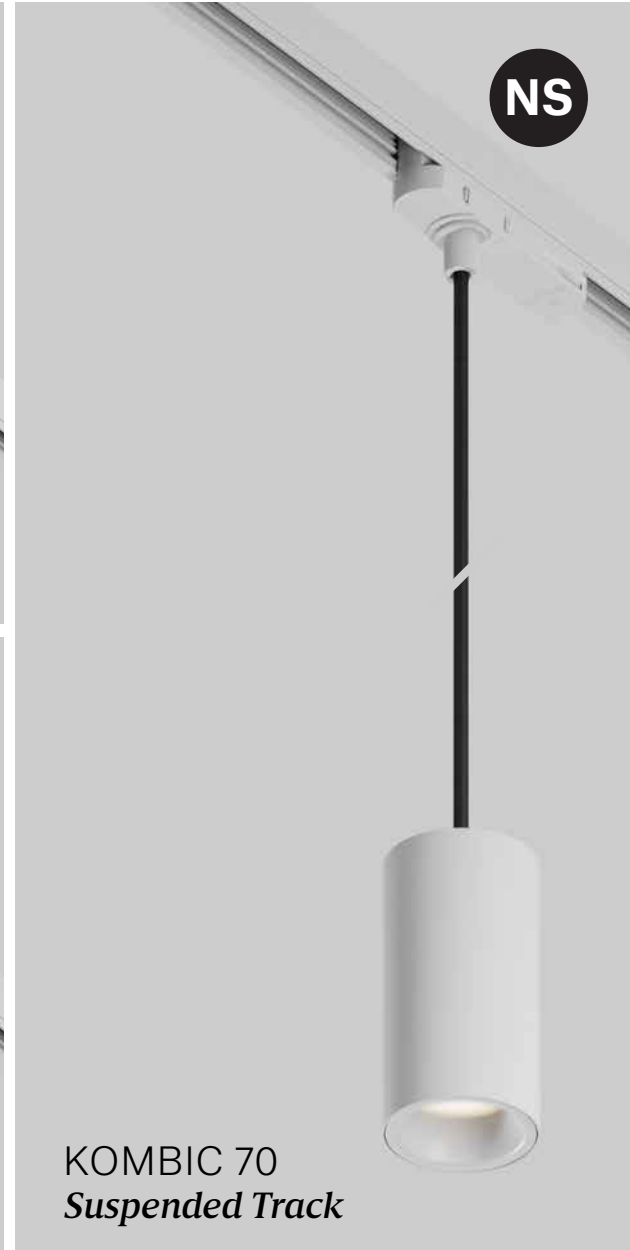

KOMBIC 70
Suspended Track



KOMBIC 70
Surface / Suspended



KOMBIC 70
Track



+ INFORMACIÓN TÉCNICA



SOLID MATE

White



Arena 2010-Y20R



SHINE - METALLIC

Bronze



Champagne



Black



Dark Chocolate 8017



Terracota 3009



Dark Gray 7022





+ INFORMACIÓN TÉCNICA

Ind.



Kombic 70

Modelos DOWNLIGHT 70



Dimensiones

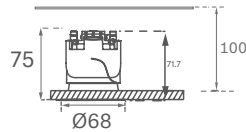

Lm LED 1500lm

IP BASIC **IP43 IP44 IP65** COMFORT & EFICIENCY **IP43**

IRC / CRI 80-90

Ángulos apertura



OPAL



OPTIC



ELLIPTIC



WALLWASHER



REFLECTOR

Temp.color 2700-3000-4000K

Equipo ON-OFF/DALI

Potencia 8,4W

Acabados

● Negro 02

○ Blanco 02

SURFACE 70

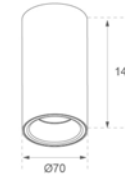

1500lm

BASIC & COMFORT **IP43** EFICIENCY **IP23**

80-90



OPAL



OPTIC



REFLECTOR

2700-3000-4000K

ON-OFF/DALI

9,5W



+ INFORMACIÓN TÉCNICA



NUEVO

KOMBIC 100
Orientable

Versatilidad en la dirección de la luz para adaptarse a diferentes necesidades de iluminación.





+ INFORMACIÓN TÉCNICA

Ind.



Kombic 100 Orientable



+20°





+ INFORMACIÓN TÉCNICA

Ind.

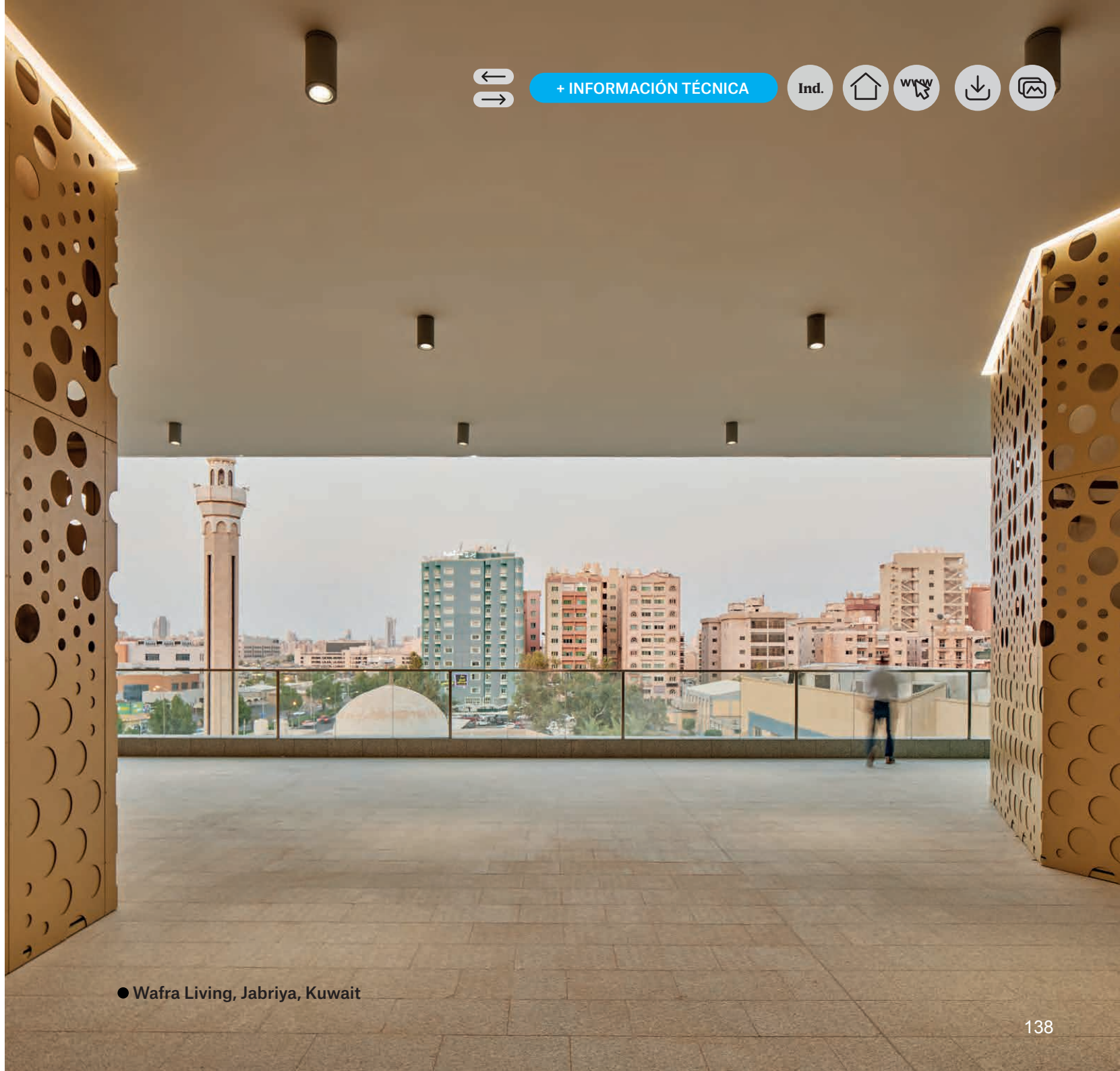

● Wafra Living, Jabriya, Kuwait

Domo 220

“Eficacia y confort visual”

La familia Domo nace por una sencilla razón, la voluntad de conseguir la máxima eficacia y confort visual en los downlights empotrados. Se trata de un producto técnico, de altas prestaciones y con un diseño muy centrado en el detalle.

Design by Lamp





+ INFORMACIÓN TÉCNICA

Ind.



Modelos

DOMO 220 G2



DOMO 220 G2 ASYMMETRIC



Dimensiones

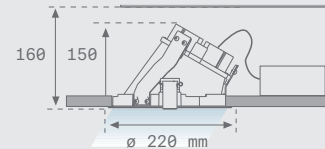
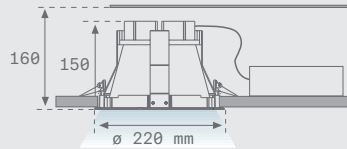

Lm LED

2000 lm - 4000 lm

IRC

80

Ángulos apertura

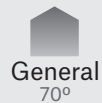

General
70°



Asym.
70°

Temp. Color

3000 / 4000 K

3000 K

Equipo

ON/OFF - DALI

Potencia

21 - 38 W

Acabados

○ Blanco 02

Acabados Acc.

● Negro 02

○ Blanco 02

● Gris 01



Reflector simétrico / asimétrico

Esta familia de downlights se compone de distintas soluciones lumínicas mediante distintos reflectores, como el simétrico y asimétrico.

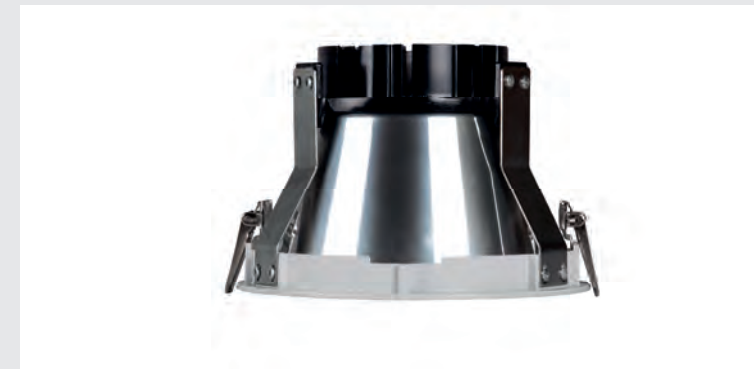

Disipador en aluminio

El disipador de la familia Domo está diseñado y dimensionado en aluminio inyectado para conseguir una correcta disipación de la temperatura y de esta forma garantizar una vida útil de los LED de al menos 50.000h.



+ INFORMACIÓN TÉCNICA

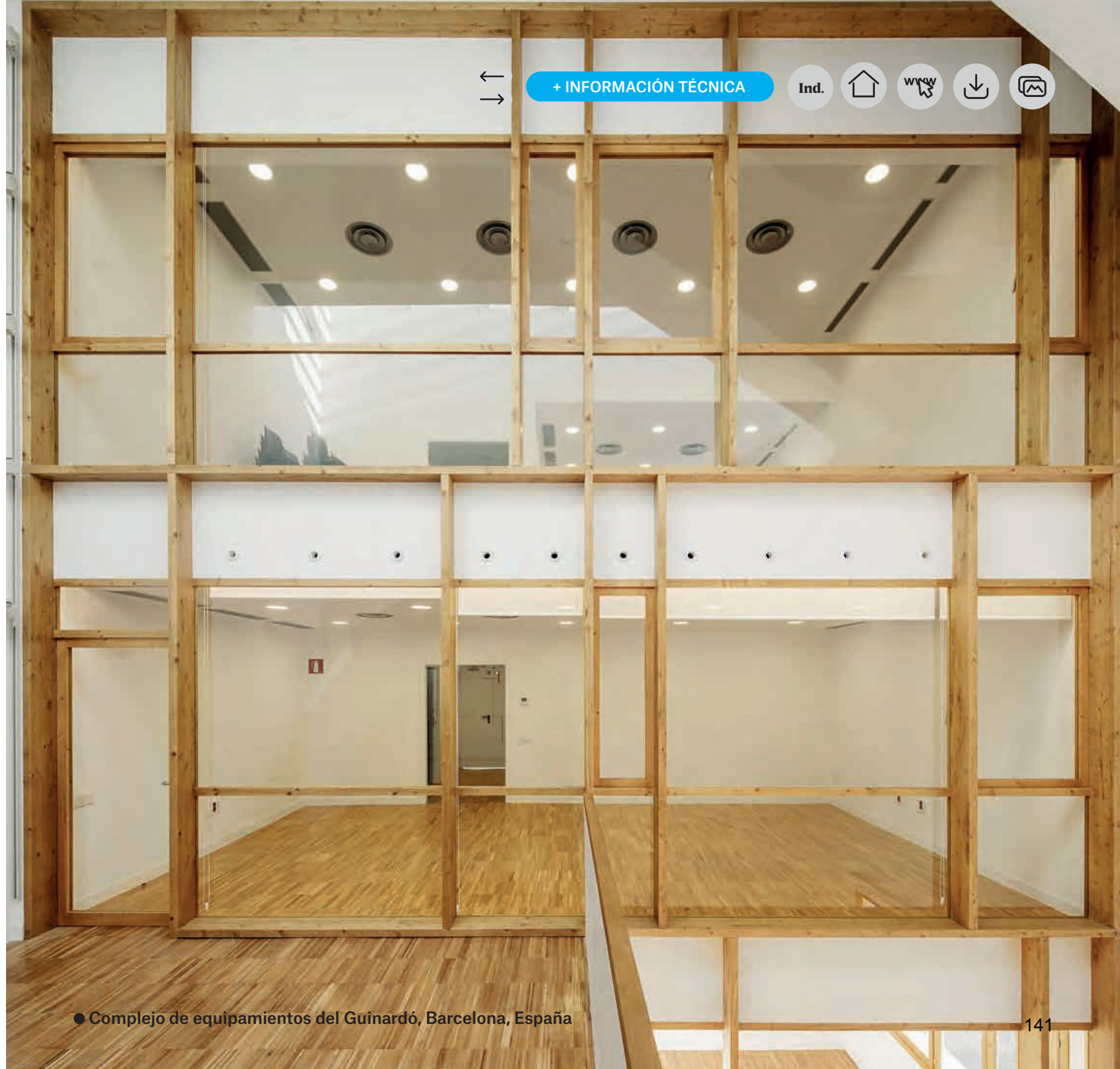

Moody

“Simplemente juega”

Una herramienta creada para jugar. Una familia en la que el concepto “Do it yourself” prevalece sobre cualquier otra cosa. Experimentar con la luz y jugar con el producto, cambiar sus partes y encontrar los diferentes roles que la luminaria puede jugar en el mismo espacio.

Design by Lamp





+ INFORMACIÓN TÉCNICA

Ind.



Integración con el entorno

Poco intrusivo con el entorno, gracias a la pequeña dimensión del aro frontal. De forma que permite la integración de un trimless pero a la vez con una fácil instalación.



Diseño del motor lumínico y disipación térmica

Diseño del motor lumínico inspirado en un objetivo fotográfico. Lejos de estar oculto, los mecanismos se muestran resaltando la belleza del diseño térmico.

Lamp Worktitude for light



Amplia gama de producto

Sistema configurable que te permite hasta 360 combinaciones (sin accesorios ópticos).



Facilidad de instalación

Instalación sin herramientas. Unión entre Core y Reflector mediante clipaje desensamblable. Fijación con el techo mediante muelles que permiten una fácil instalación y desmontaje. Es esencial el uso de corona en su agujero de empotramiento.



+ INFORMACIÓN TÉCNICA

Ind.



Modelos

ROUND



SQUARE



MINI



ASYMMETRICAL



ADJUSTABLE



Dimensiones Core 800

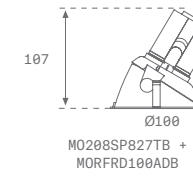
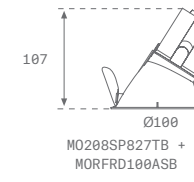
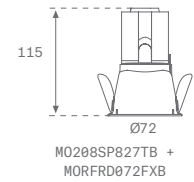
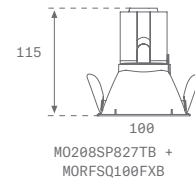
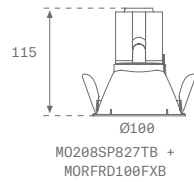

Dimensiones Core 1700

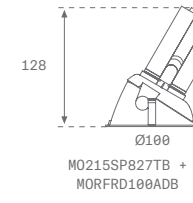
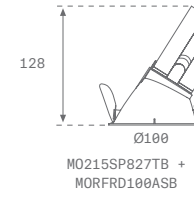
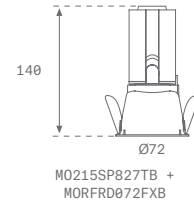
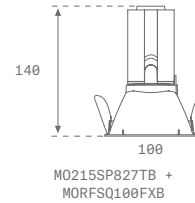
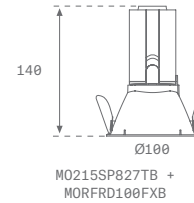

Lm LED 800 lm - 1700 lm

IRC 80 / 90

Ángulos apertura



Temp. Color 2700 / 3000 / 4000 K

Equipo ON/OFF - DALI - TRIAC

Potencia 5 - 12 W

Acabados Acc. ● Negro 03 ○ Blanco 02 ● Gris 01 ● Cobre 01



Moody 800

Disipación térmica



Chip On Board LED
2700K - CRI 90
3000K - CRI 80
4000K - CRI 80

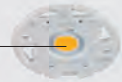

Reflector óptico

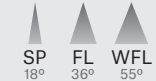

Accesorios ópticos

(max. 2 accesorios aplicables por luminaria)



Reflector embellecedor para empotrar

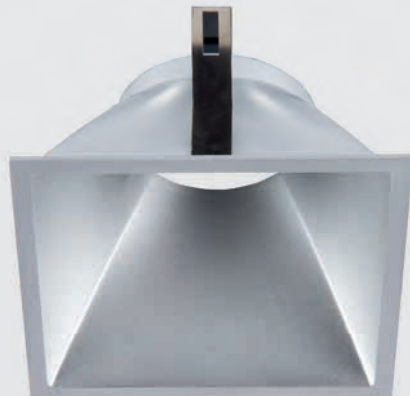

Motor lumínico

1 | Motor lumínico



2 | Accesorios ópticos



Accesorios decorativos

3 | Reflector embellecedor para empotrar



4 | Diferentes tipos de acabados





+ INFORMACIÓN TÉCNICA



● Yoga One by DIR, Rubí, España



+ INFORMACIÓN TÉCNICA

Ind.

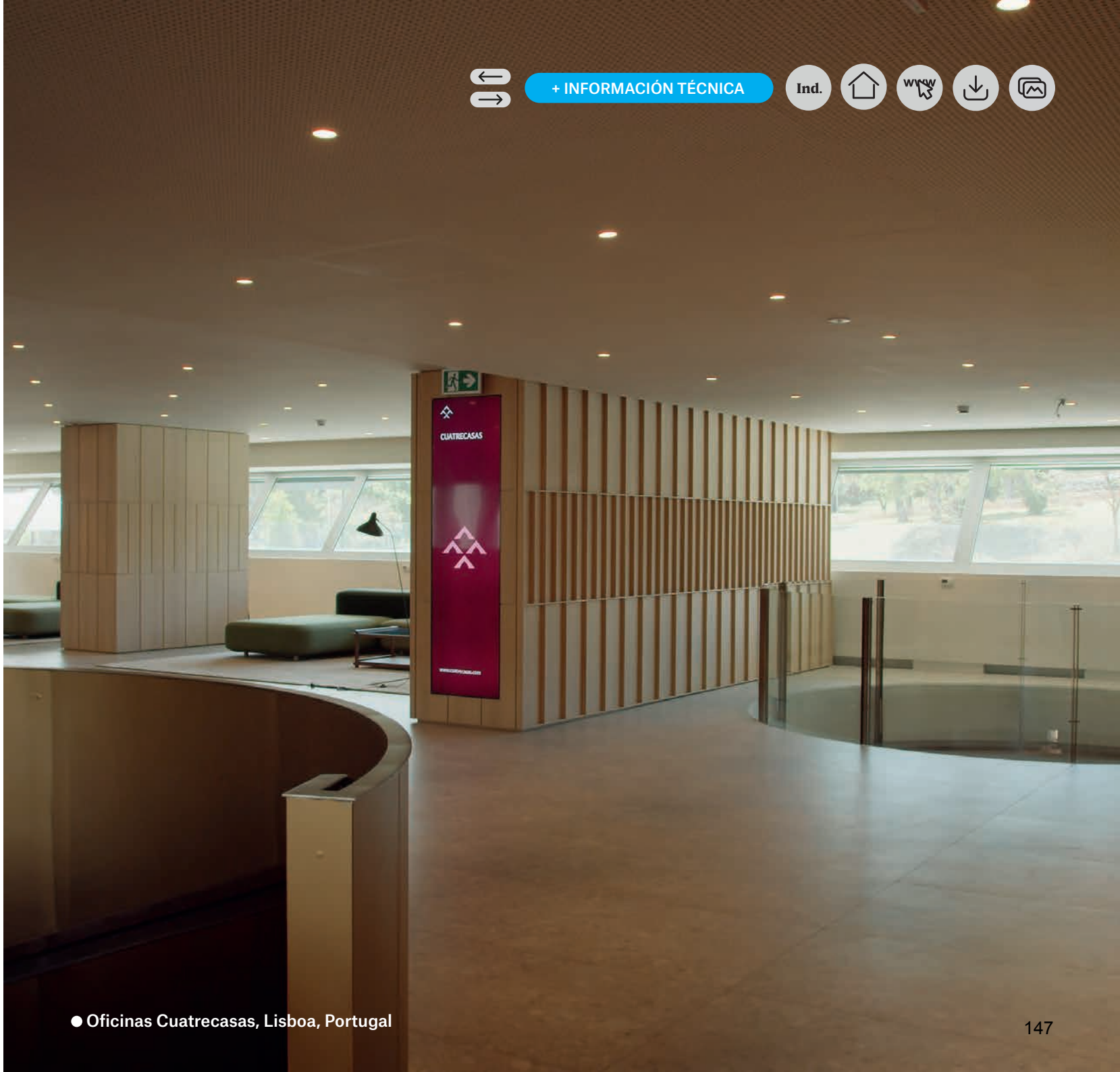



Stormbell 80

"Hacer de la oficina un lugar para sentirse como en casa"

Manteniendo la inspiración racionalista de su predecesora, Stormbell 80 mantiene los requisitos técnicos ofreciendo una iluminación de gran calidad, confort lumínico y control del deslumbramiento bajo la adopción de un lenguaje amable para los nuevos espacios en constante evolución.

A través de la miniaturización y de la propuesta de 4 modelos de campanas de diferentes formas, tamaños y materiales, esta solución genera variadas sensaciones de luz y proximidad lumínica.

Design by Artec Studio





Propuesta técnica envuelta en un lenguaje amable:

Una nueva solución de iluminación para los espacios de trabajo en constante evolución, que ofrece una iluminación técnica de gran calidad en un motor lumínico miniaturizado con un gran aporte de confort lumínico y una gran variedad tecnológica que permite la selección de tecnologías estándar en diferentes CCT (2700 -4000K) y tecnología estándar o Wellbeing para la optimización circadiana y la contribución con el bienestar de los usuarios.



Iluminación Flexible:

Múltiples posibilidades de instalación: suspendido con florón empotrado o en superficie, o bien instalación en carril para integración en Sistema Nomadic.



Criterios de ecodiseño:

Diseñado bajo un concepto de economía circular que facilita la recuperación y reutilización de las luminarias. Se introduce el uso de materiales reciclados como el fieltro de PET reciclado (procedente de botellas) o en corcho reciclado (procedente de tapones).



+ INFORMACIÓN TÉCNICA

Ind.

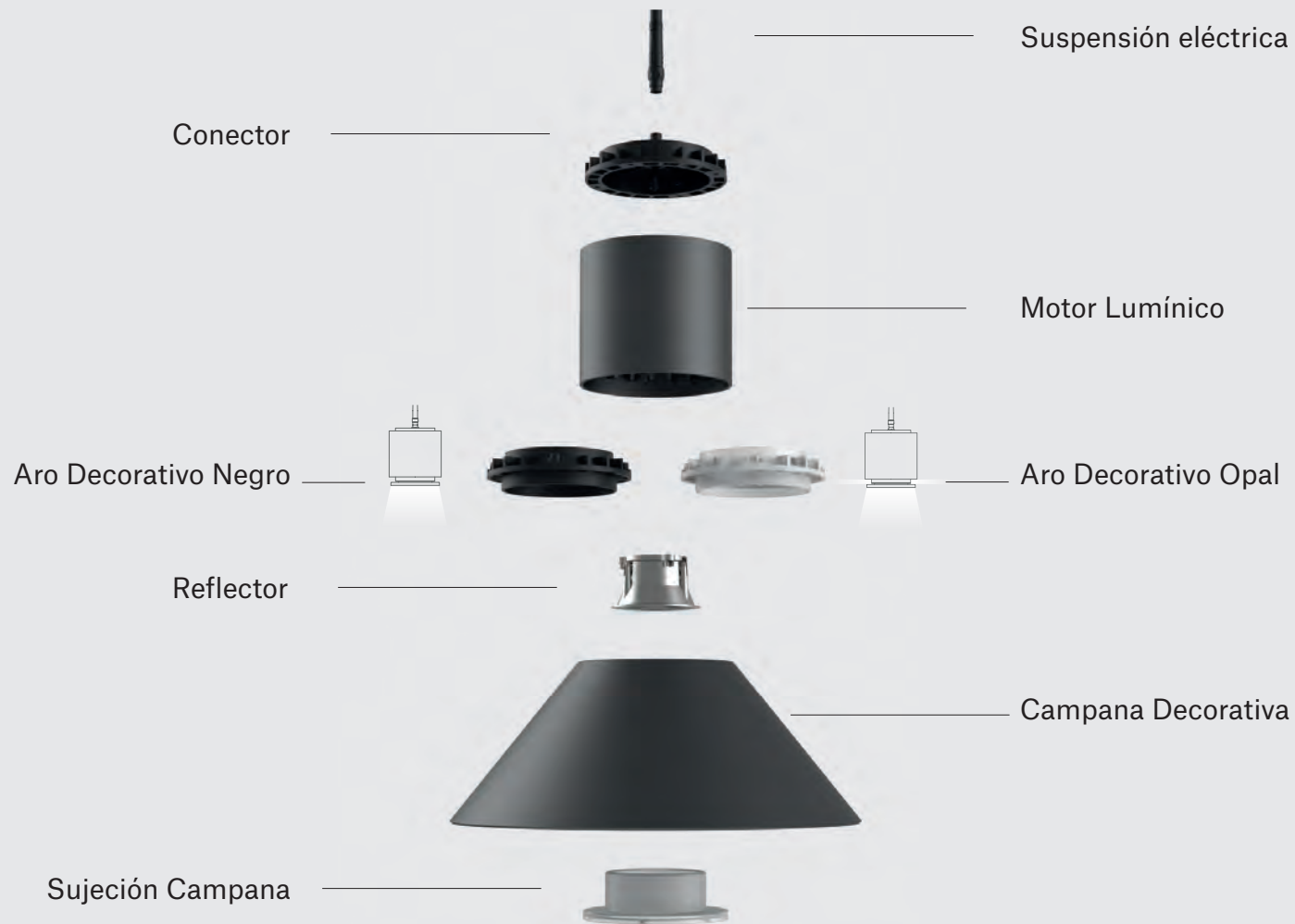

Stormbell 80 | Indoor



+ INFORMACIÓN TÉCNICA

Ind.



+

Motor Lumínico

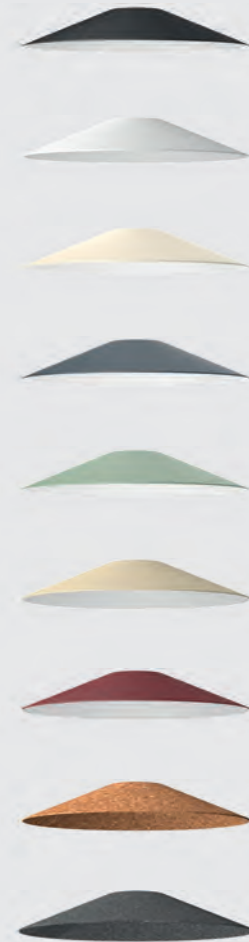

Acabados Estandar

Paleta Materiality

Materiales Recicladados

Accesorios Reflectores

SP 15° MFL 23°

SP 15° MFL 23° WFL 57°



+ INFORMACIÓN TÉCNICA

Ind.



Paleta Materiality

Recuperación de la materialidad

Experiencias reales

Reciclaje

Conocimiento + Conciencia: Consumo sostenible



1505-Y10R



7024



3010-G



2010-Y20R



3013



Promoción de la sostenibilidad y la integración social:

Diseñado bajo un concepto de economía circular que facilita la recuperación y reutilización de las luminarias.

Campanas de PET: Procedente del reciclaje de botellas

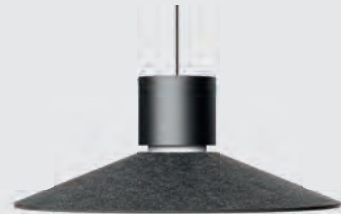

Material	Filtro Poliéster
Composición	20-60% rPET (botellas y otros envases reciclados)
Kg	0,134
Procedencia	4 botellas de agua recicladas

Campanas de Corcho reciclado: Procedente de tapones de vino y cava recogidos por personas con dificultades de integración social.



Material	Corcho Reciclado
Composición	80-90% tapones de corcho reciclados
Kg	0,227
Procedencia	40 tapones de vino reciclados



+ INFORMACIÓN TÉCNICA

Ind.



Modelos

SUSPENDED RECESSED



SUSPENDED SURFACE



NS SUSPENDED TRACK



Dimensiones

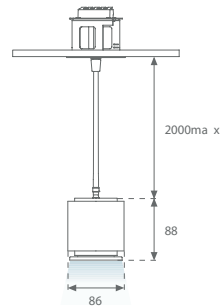

ON/OFF

DALI

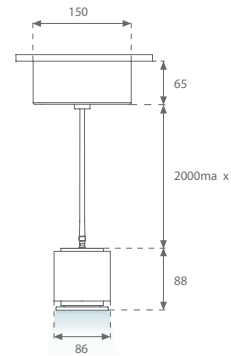
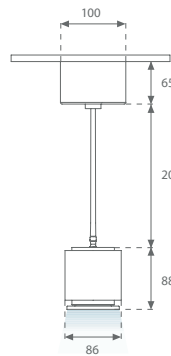

ON/OFF

DALI

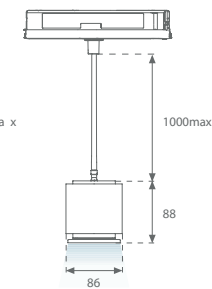
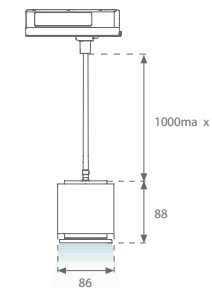

Lm LED 1500 lm

IRC 90

Ángulos apertura



Temp. Color 2700 / 3000 / 4000 K / TW / 3000 WB / 4000 WB

Equipo ON/OFF - DALI

Potencia 14W

Acabados ○ Blanco 04 ● Negro 04

Paletas Materialitty ● 1505-Y10R ● 7024 ● 3010-G ● 2010-Y20R ● 3013

Stormbell 80

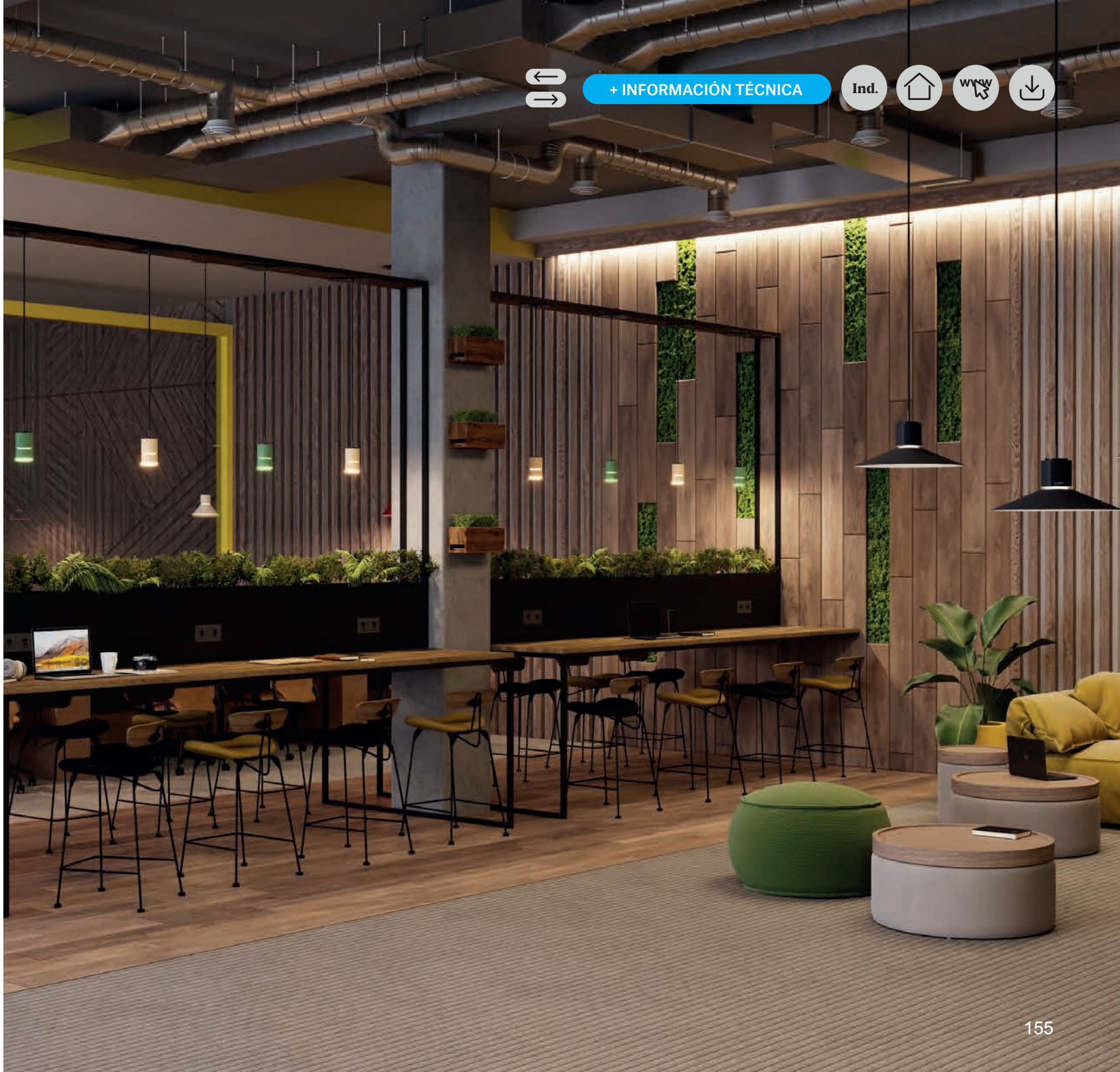

+ INFORMACIÓN TÉCNICA



Stormbell

“Una campana de diseño atemporal”

Un diseño atemporal con una clara inspiración racionalista. La interacción entre las tipologías de iluminación y accesorios le permite crear diferentes ambientes y ser perfecta para aplicaciones de hospitality y retail.

Design by Artec Studio

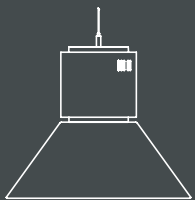



+ INFORMACIÓN TÉCNICA

Ind.



Geometrias puras y diseño atemporal

Su diseño surge como resultado de la combinación de geometrias puras. Inspirado en el diseño atemporal de la escuela Bauhaus (referencia de diseño).



La forma expresa la función

Sus formas hablan de la disipación térmica necesaria para la correcta gestión térmica del LED.



Stormbell Deco

Modelo con efecto de luz difusa en la unión del Core con el reflector. Los reflectores/difusores, están fabricados en policarbonato especial para LED, en tres tipos de acabados: blanco, negro y opal.

Lamp Worktitude for light



Sistema configurable

Sistema configurable que te permite escoger la mejor combinación para cada espacio. Con 144 combinaciones distintas.



+ INFORMACIÓN TÉCNICA

Ind.



Modelos

STORMBELL



STORMBELL DECO



Dimensiones

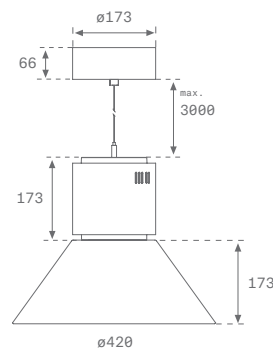
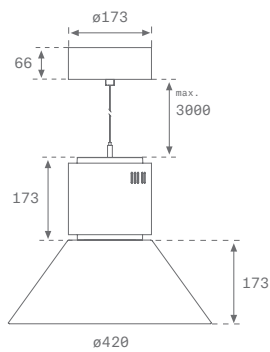

Lm LED

IRC 80

Ángulos apertura

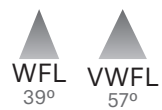

Temp. Color 3000 / 4000 K

Equipo ON/OFF

Potencia

Acabados Blanco 04 Blanco 04 Negro 04



+ INFORMACIÓN TÉCNICA

Ind.





+ INFORMACIÓN TÉCNICA

Ind.

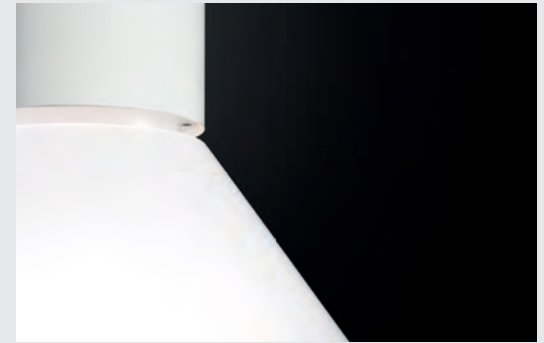



+ INFORMACIÓN TÉCNICA





+ INFORMACIÓN TÉCNICA

Ind.



Mun

“Luz para ver y luz para contemplar”

Entendemos la luz como una herramienta para cubrir aspectos técnicos y funcionales, pero también podemos utilizarla como una herramienta para generar entornos. Luz para ver y luz para contemplar. ¿Por qué no aportar las dos visiones en una misma familia?

Design by Lamp

Amplitud de familia

Mun Light cuenta con un diseño que permite una luminaria con una mínima altura de alzado de 43mm, proporcionando una superficie lumínica uniforme en todos los diámetros disponibles para que se puedan combinar entre ellos: 350mm, 450mm y 600mm. Instalación disponible en superficie y suspendida mediante accesorio.

Mun Dark es un producto versátil de iluminación indirecta que permite realizar diferentes composiciones en el espacio aportando iluminación ambiental. Disponible en diámetros de 120mm, 180mm y 300mm para instalar en superficie a pared o en composiciones.

Confort y bienestar

Exenta de riesgo fotobiológico UNE 62471.

Flicker-free: Cumplimiento con métodos IEEE estándar 1789 -2015 LED y según NEMA 77-2017 (.Pst LM<1.0 y SVM <0,6).

Dos posibilidades de flujos luminosos: LO (Low output) y MO (Medium Output).

Difusor Prismático para control del deslumbramiento activo: UGR<19 (LO y MO).

Temperatura de Color: 3000K 4000K.

Excelente reproducción cromática CRI90.

Luminancia en superficie luminosa equivalente en todos los modelos para poderse combinar entre sí.

Ecodesign criteria

Materialidad: cuerpo fabricado en extrusión de aluminio reciclado.

Eficiencia: de hasta 141lm/W.



MUN DARK



MUN LIGHT

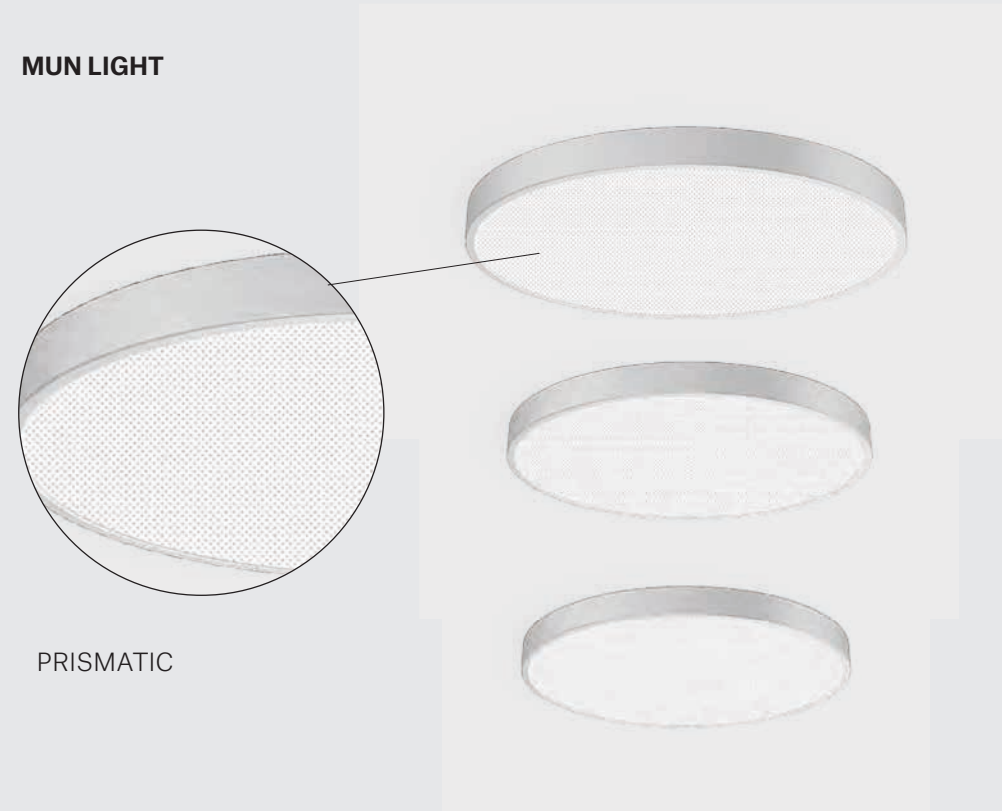



+ INFORMACIÓN TÉCNICA

Ind.



Modelos

MUN LIGHT



MUN DARK



Dimensiones

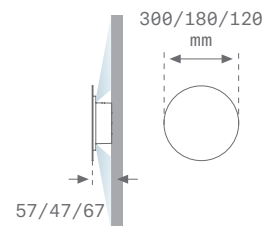
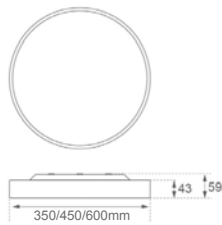

Lm LED

1000 lm - 1700 lm

100 lm - 300 lm

IRC

90

80

Ángulos apertura



Temp. Color

3000 / 4000 K

Equipo

ON/OFF

Potencia

8 - 60 W

1 - 3 W

Acabados

○ Blanco 05

● Negro 05



+ INFORMACIÓN TÉCNICA

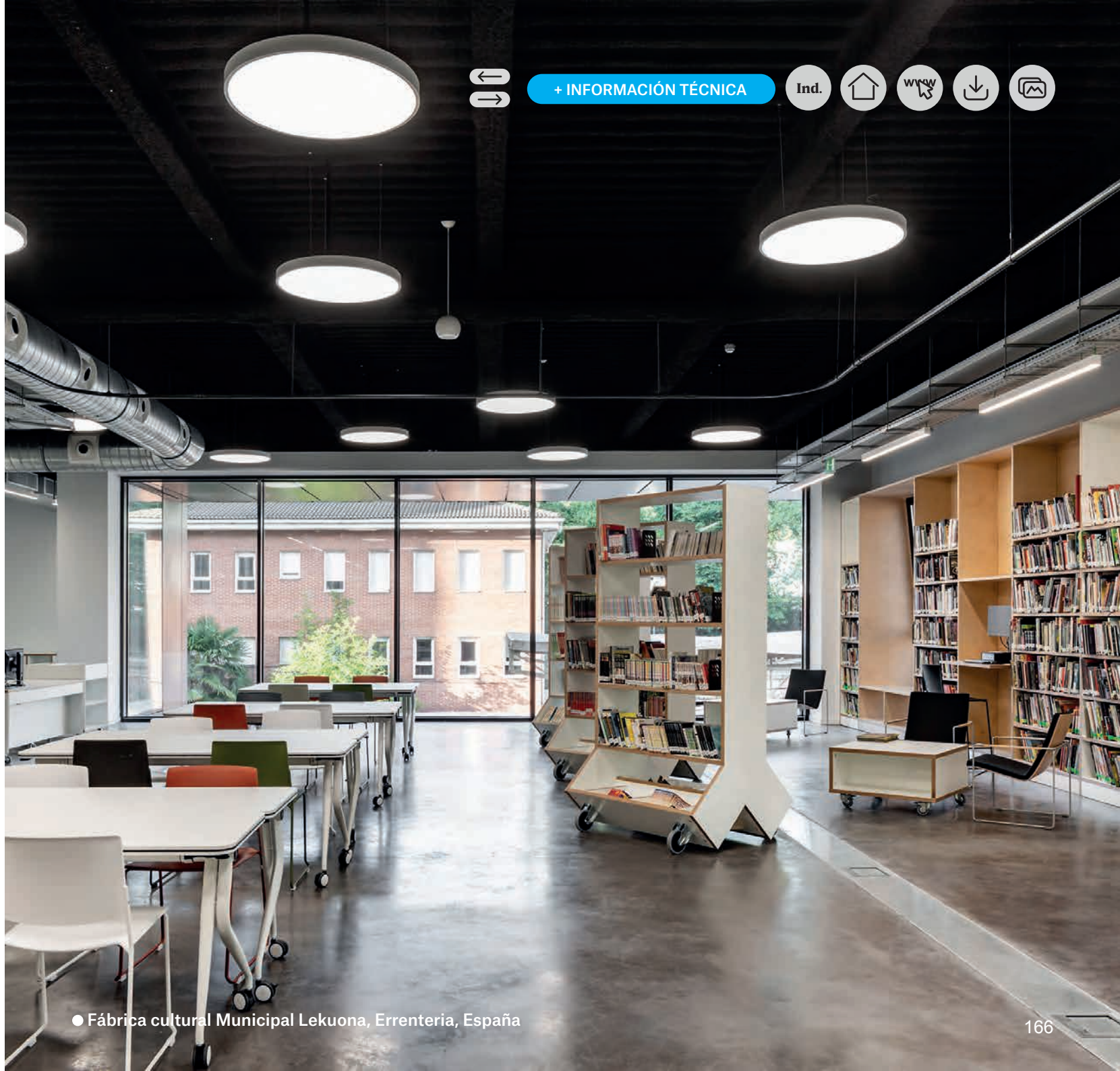



+ INFORMACIÓN TÉCNICA

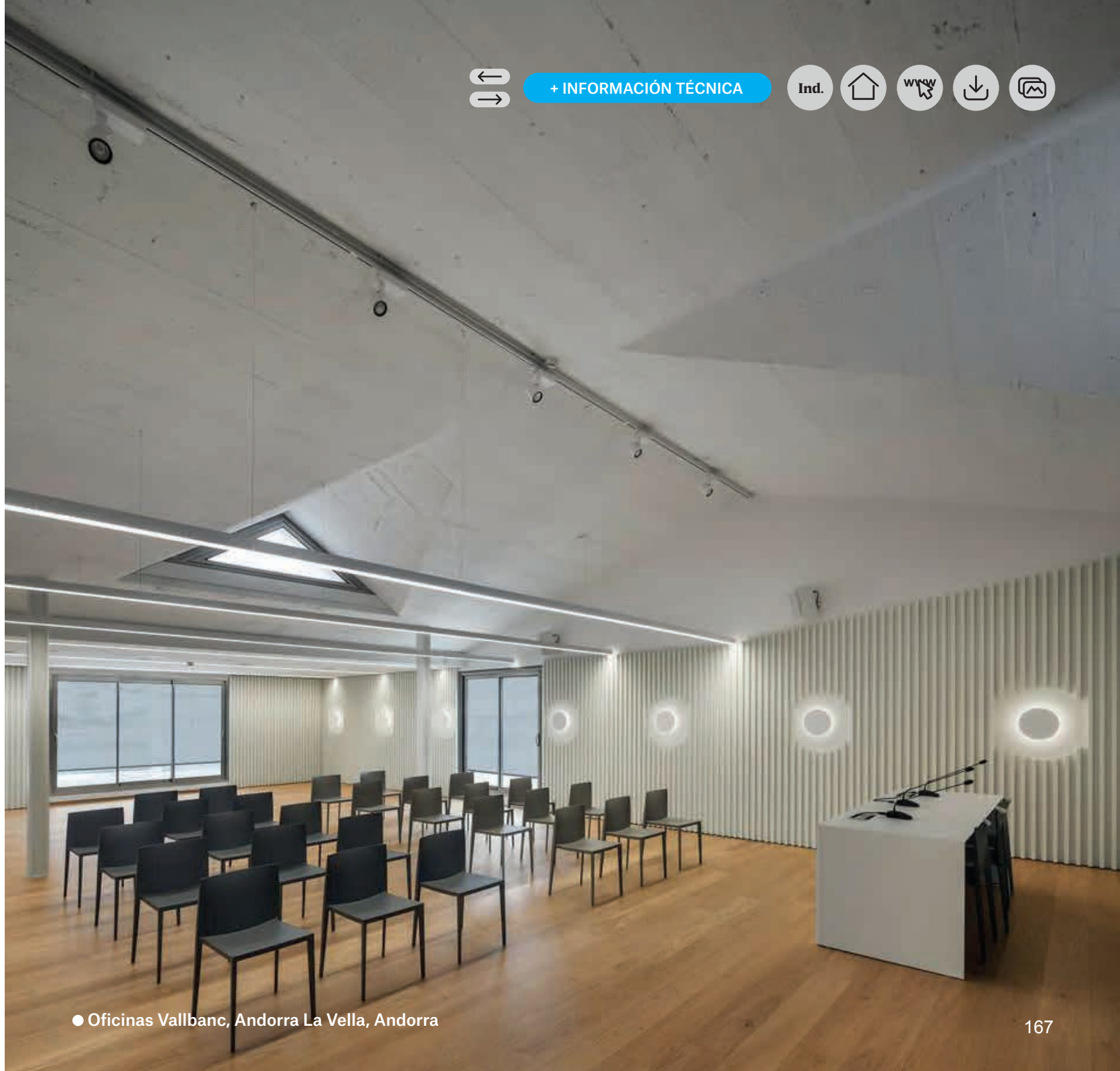



Ambient G2

"La técnica de la luz ambiental para modelar el espacio"

Solución lineal de iluminación adosada a pared, que responde a unas altas exigencias técnicas, maximizando la expresión volumétrica del espacio.

Design by Lamp

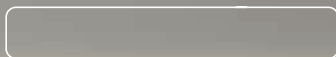



Confort visual y bienestar

Exenta de Riesgo Fotobiológico: Group 0” según standard recomendado en la norma UNE 62471.

Control de parpadeo (Flicker-Free): Cumplimiento con métodos IEEE estándar 1789 -2015 LED y según NEMA 77-2017 (.Pst LM<1.0 y SVM <0,6).

Distribuciones Directas e Indirectas: Mejorando el balance visual y la iluminancia vertical.

Múltiples distribuciones lumínicas adaptadas a las necesidades de los usuarios (Opal, Asimétrica, Grazer).

CCT 3000K y 4000K, Tecnología LED dinámica con adaptación de temperatura de color (2700-6500K).

Ecodesign criteria

Materiales: Reducción de la huella de CO2 en la fabricación gracias al uso de aluminio reciclado.

Aluminio reciclado: Fabricado en aluminio de extrusión reciclado en una tasa de de 80% con sello ASI.

Eficiencia: hasta 142 lm Out/W

Circularidad: Diseñada bajo el criterio de ecodiseño:

Reducir: más compacto, menos materiales.

Reutilizar: incorporando materiales de origen reciclado y reciclable.

Reparar: Extendemos la vida útil del producto gracias a un producto modular, extendiendo su fase de uso (B6).

Reciclar: Producto desensamblable para evaluar su valorización al final del ciclo de vida.



Tres versiones ópticas combinables entre sí

GENERAL LIGHTING: Distribución Opal para general una comfortable luz ambiental, aumentando el confort visual y contribuyendo al aporte de iluminación cilíndrica.

EFFICIENT LIGHTING: Óptica asimétrica para maximizar el efecto lumínico en planos horizontals (Techos y suelos), iluminados desde el perímetros.

ACCENT LIGHTING: Óptica "grazer" para enfatizar los paramentos verticales y resaltar texturas.

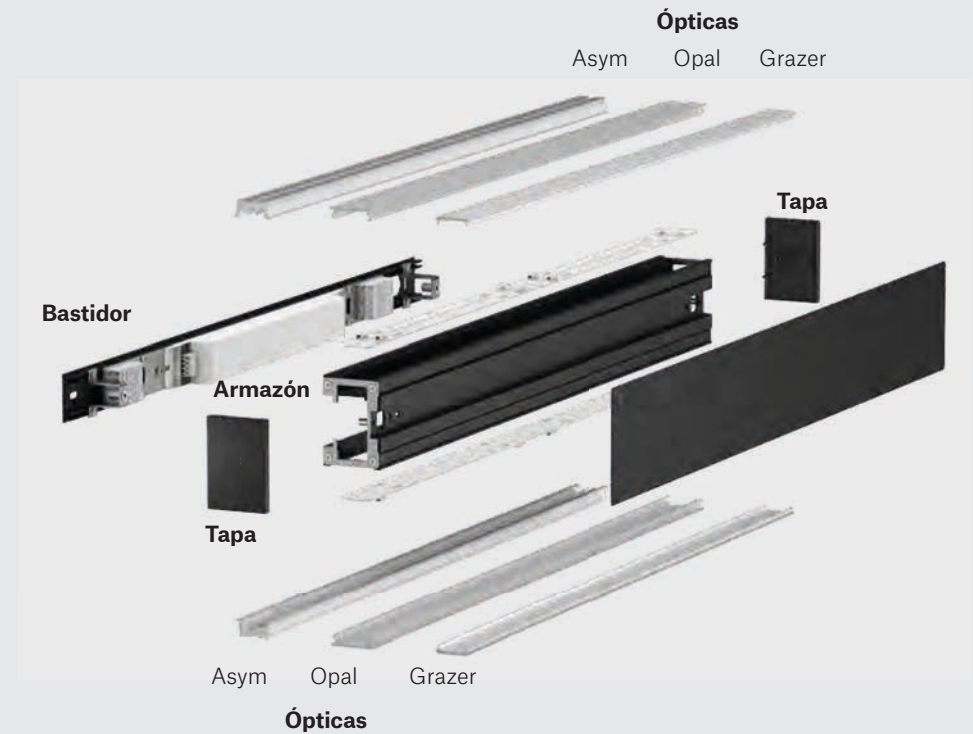
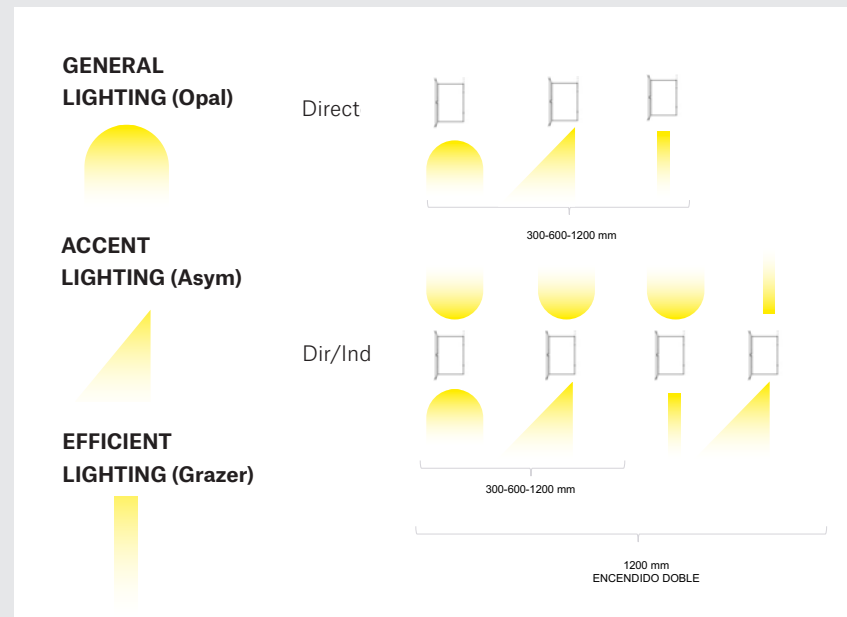

Aplicación y funcionalidad

Instalación individual y en Línea Continua: Bastidor preinstalado a pared para absorber irregularidades de la superficie y facilitar la instalación de líneas continuas.

Diversidad de aplicaciones: Encendido individual y doble, para un control preciso en función de la aplicación lumínica.

Acabados luminaria:

- BLANCO / NEGRO.
- Paletas FOUNDATION y RETROPIA.

Acabados accesorio frontal:

- BLANCO / NEGRO.
- ANODIZADOS: Oro, bronce, champán, azul y negro*.
- RAW: la materialidad más honesta*.

**Acabado solo disponible para accesorio frontal.
Luminaria disponible solo en blanco o negro.*

RETROPIA



FOUNDATION



+ INFORMACIÓN TÉCNICA

Ind.





+ INFORMACIÓN TÉCNICA

Ind.



ACABADOS ACCESORIO FRONTAL:

NEGRO

BLANCO

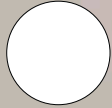

Anodizado
NEGRO



Anodizado
BRONCE



Anodizado
AZUL



Anodizado
CHAMPÁN

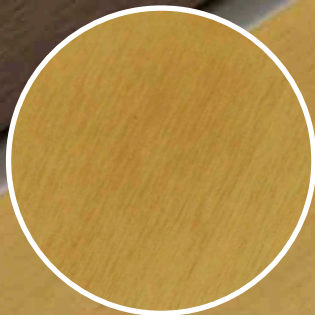

Anodizado
DORADO













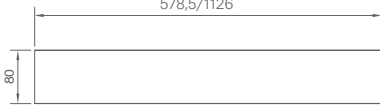

RAW



+ INFORMACIÓN TÉCNICA

Ind.



Modelos	INDIVIDUAL Direct Direct/Indirect Double Switch	CONTINUA Direct Direct/Indirect Double Switch			
					
Dimensiones	300-600-1200mm	600-1200mm			
					
					
LM LED	2500lm/m				
IRC	80				
Ángulos apertura	Opal 	Asimétrico 	Grazer 		
Temp. Color	3000K	4000K	TW		
Equipo	ON/OFF	DALI			
Potencia	Direct 6W 10W 19W	Direct / Indirect 10W 19W 35W	Double Switch 35W		
Acabados	Black 02 	White 02 	Retropia 	Foundation 	Anodized (acc.) 
	*Acabado solo disponible para accesorio frontal.				

FIL SYSTEM

Design by Lamp





Confort visual

Las soluciones lumínicas integradas cumplen con altos requisitos:



Control del deslumbramiento activo:
opal confort.

Luminarias “exenta de riesgo”
RGO según la normativa de Riesgo Fotobiológico UNE 62471.

Modelos de **alto confort visual con gran ángulo de apantallamiento, reflectores negro y utilización de ópticas ultra confort.**

Concepto modular y versatil

Diferentes tipologías de luminarias, distribuciones lumínicas y temperaturas de color para **integrar en un solo sistema las diferentes aplicaciones requeridas por el proyecto**, ya sean iluminación general o de acentuación.



Sostenibilidad

Diseñado bajo un concepto de economía circular que facilita la recuperación y reutilización de las luminarias.
Fabricado en aluminio de extrusion reciclado.

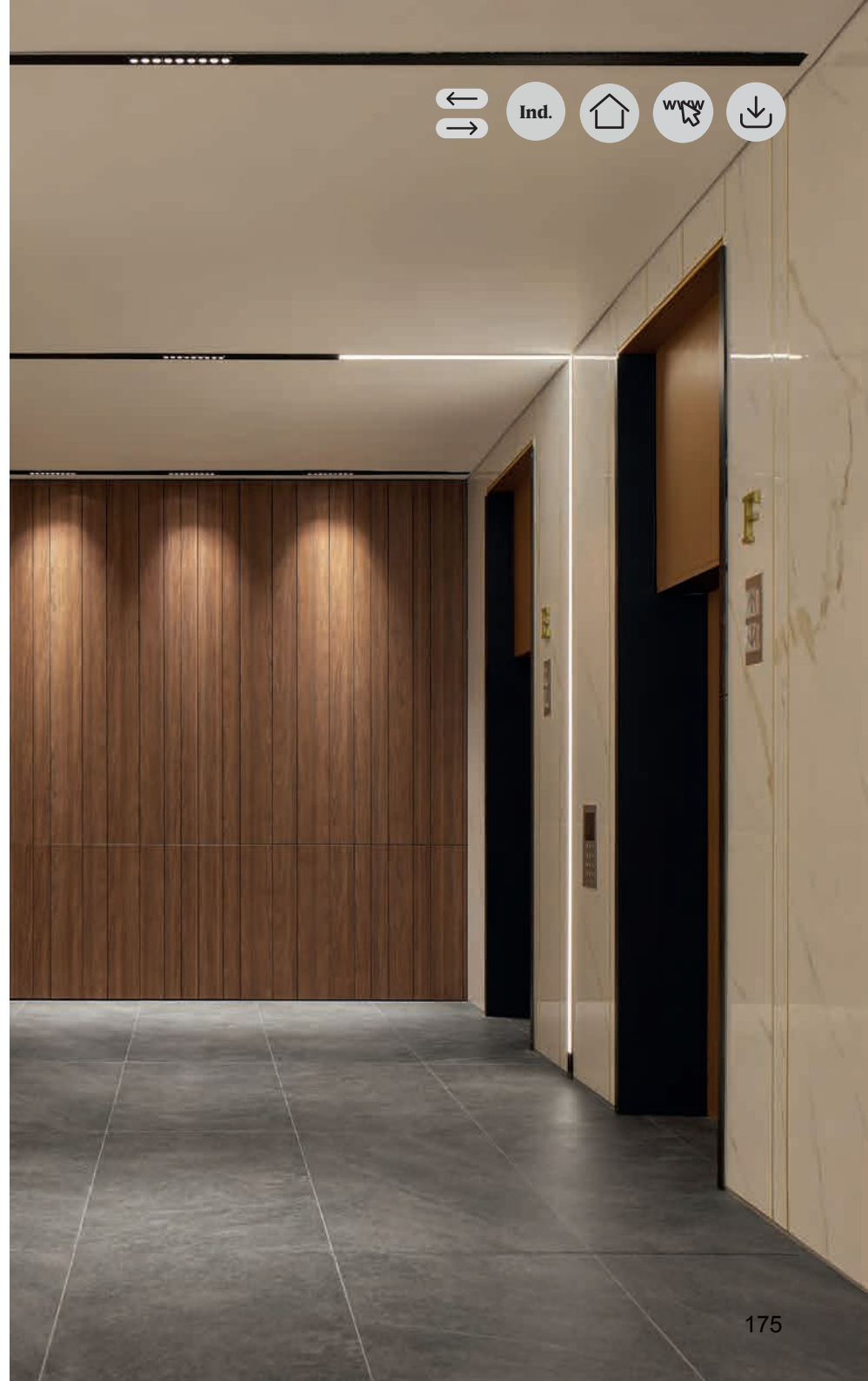

Configurador Fil 45

Es un sistema **configurable y combinable que se adapta** a las necesidades de cualquier proyecto.

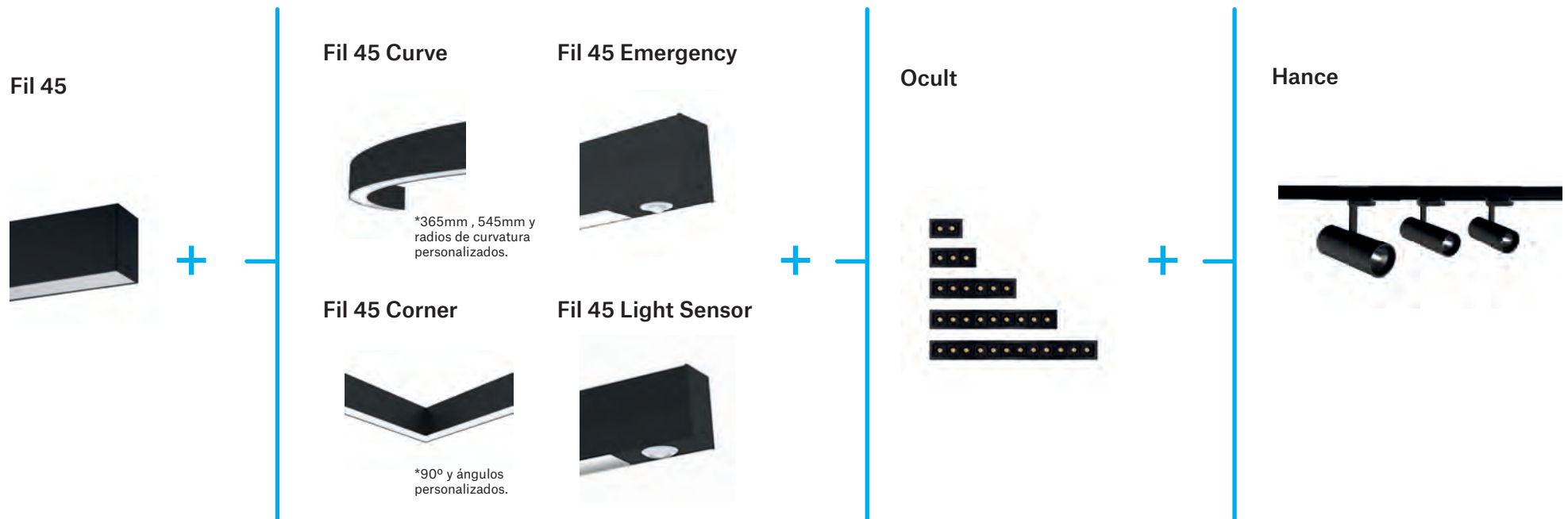

Fil 45 Emergency

Las emergencias Fil 45 ofrecen una solución completamente integrada en las luminarias para aportar seguridad, acorde a normativa, de fácil instalación y mantenimiento.

Es una solución **confiable y que garantiza la seguridad de los usuarios.**



Fil 45 Emergency

SISTEMA DE EMERGENCIA INTEGRADO

Todo integrado en una **única solución luminica**. Garantiza la disponibilidad de iluminación de emergencia en caso de cortes de luz, lo que aumenta la **seguridad de los usuarios y permite una evacuación segura en situaciones de emergencia**. **Indicador de estado integrado** para confirmación de funcionamiento. Tecnología estándar.

VERSATILIDAD Y FLEXIBILIDAD

Disponibilidad de 3h de autonomía que aseguran un funcionamiento ininterrumpido durante situaciones de emergencia, según necesidades.

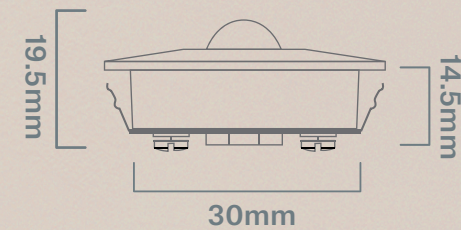
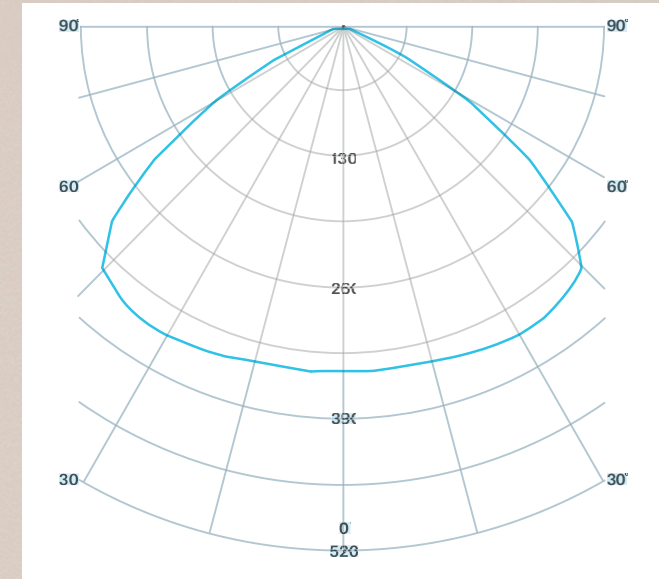

Fil 45 Light Sensor

El complemento de sensor de luminosidad y presencia integrado en la familia de luminarias Fil 45 de Lamp ofrece ventajas en términos de **ahorro energético, confort visual, comodidad y cumplimiento normativo.**



Fil 45 Light Sensor



AHORRO ENERGÉTICO

El complemento de sensor de luminosidad y presencia permite que la luminaria Fil 45 **ajuste automáticamente su nivel de iluminación en función de la cantidad de luz natural disponible en el entorno**. Esto garantiza un uso eficiente de la energía al evitar el encendido innecesario de luces cuando hay suficiente luz natural.



CONFORT VISUAL

Al adaptarse a las condiciones de luz ambiental, la luminaria Fil 45 proporciona un **ambiente cómodo y sin deslumbramientos**, lo que contribuye al bienestar visual de los usuarios.



INTERACCIÓN EFICIENTE

Permite un encendido automático de la luminaria según se detecte presencia en la sala. Así como el apagado automático cuando no haya presencia, también permite la **configuración personalizada** de un apagado gradual, permitiendo reducir el flujo durante unos minutos, antes de proceder al apagado completo, según especificación.



Fil 45 Curve

Fil 45 Curve complementa la familia Fil 45 ofreciendo dos radios de curvatura para una **mayor versatilidad en la iluminación de espacios.**

Fil 45 Curve



RADIOS DE CURVATURA

365mm
545mm



FLEXIBILIDAD DE INSTALACIÓN

Disponible en perfil de superficie y con opción a **suspensión**, facilitando su integración en diferentes configuraciones y diseños de iluminación.

COMPATIBILIDAD Y VERSATILIDAD

Combinable con otros productos de la **Fil 45** como rectas, corners de 90° e incluso ángulos personalizados. Esto permite una optimización creativa en los proyectos de iluminación y una mayor **flexibilidad en el diseño**.

PERSONALIZACIÓN

Posibilidad de **fabricación de radios de curvatura personalizados** para satisfacer requisitos específicos de iluminación. Nuestro equipo está capacitado para **diseñar formas, tamaños y tecnologías de iluminación personalizadas**.

Radio min. personalizado: 365mm

Radio máx. personalizado: a consultar



+ INFORMACIÓN TÉCNICA

Ind.



Fil 45 Curve

Modelos

OPAL



OPAL COMFORT



Dimensiones

SURFACE

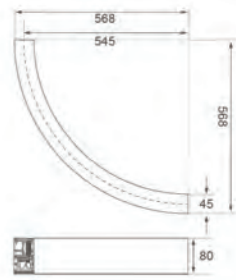
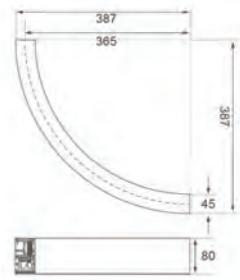

Lm LED

Radios curvatura

365 mm

545 mm

IRC

80 / 90

Ángulos apertura



Opal



Opal
Comfort

Temp. Color

3000 / 4000 K

Equipo

ON/OFF - DALI

Acabados Acc.

● Negro 02

○ Blanco 02

● Gris 01



+ INFORMACIÓN TÉCNICA

Ind.



Realizaciones de proyectos

Fil 45



+

Fil 45 Curve



*365mm ,
545mm y radios
de curvatura
personalizados.

Fil 45 Corner



*90° y ángulos
personalizados.

Fil + Fil Curve / Corner



Rivana Business Park Torre Norte (Oficinas Tigo), Colombia



RCI Sofasa, Colombia

Realizaciones de proyectos

Fil 45



+

Ocult



Fil + Ocult



Centro Empresarial Central Point, Colombia

Realizaciones de proyectos

Fil 45



Hance



Fil + Hance



Preescolar Sagrado Corazón Montemayor, Colombia



FIL

“Versatilidad lumínica y alto confort visual”

FIL combina una familia versátil, bajo un diseño que ofrece múltiples opciones de instalación y acabados, así como una extensa variedad de flujos lumínicos y prestaciones ópticas.

Design by Lamp

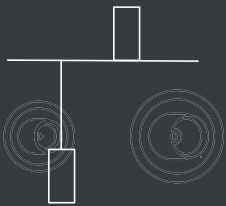



+ INFORMACIÓN TÉCNICA

Ind.



Fil 35

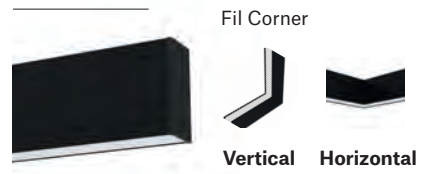

Fil 45



Fil 50



Fil 70

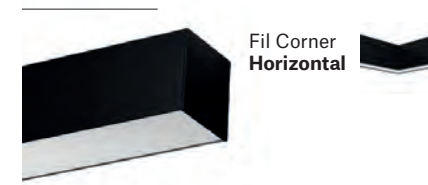

Fil 120

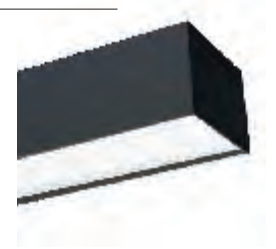

Instalación

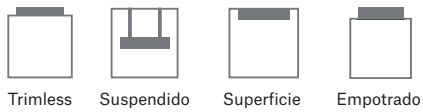

Óptica



Distribución



Dimensiones disponibles

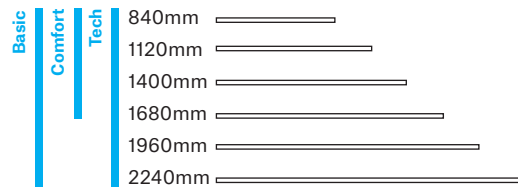

1123mm

1683mm

1162mm

1740mm

Acabados



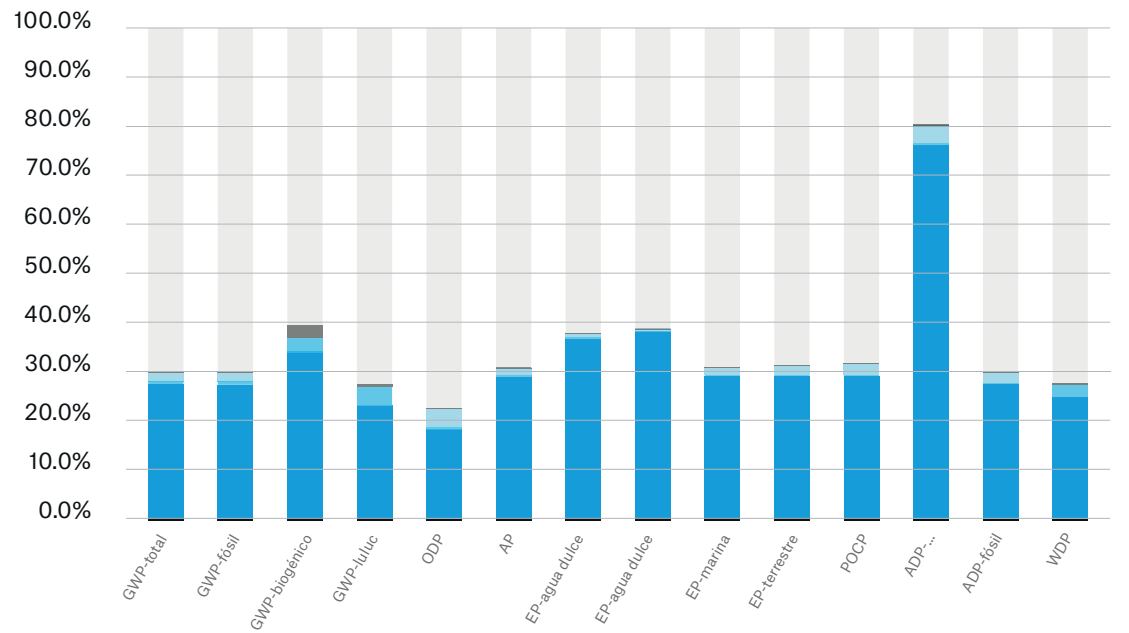
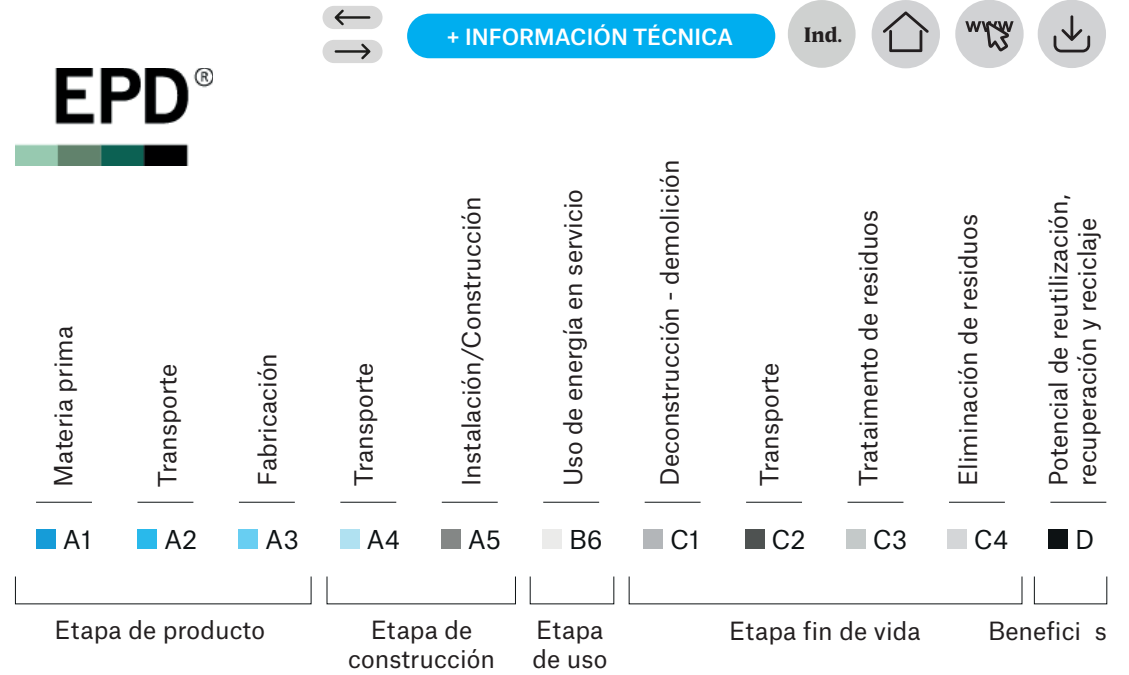

TECH ULTRACOMFORT

Design by Lamp

FIL 35 & FIL 45





Fil 35



Confort y bienestar



SALUD VISUAL

UGR 12

Control del deslumbramiento activo a través de la óptica **TECH ULTRACOMFORT**.

Flicker free.



MATERIALIDAD

Reducción del 40% de la huella de CO₂ en la fabricación gracias al uso de aluminio reciclado.



EFICIENCIA

Hasta **99 lm output/W**.



CIRCULARIDAD

Concebido bajo criterio 3R:

Reducción de materiales: gracias a su miniaturización.

Reutilización: incorporando materiales reciclados de origen postindustrial.

Reciclable: concebido para mejorar su separabilidad y reciclabilidad al final de su ciclo de vida, y facilidad de mantenimiento.



DECLARACIONES AMBIENTALES DE PRODUCTO

En base UNE 15804.

Cuantifica el impacto en la huella de carbono considerando toda la vida del producto. Facilitando la información para el ACV (Análisis de Ciclo de Vida) del edificio.



+ INFORMACIÓN TÉCNICA

Ind.





Fil 45



Confort y bienestar



SALUD VISUAL

UGR <16

+ INFORMACIÓN TÉCNICA

Ind.



Control del deslumbramiento activo a través de la óptica **TECH ULTRACOMFORT**.

Flicker free.

Efecto Dark Light: es inferior a 200cd/lm² por encima de un ángulo de visión de 60°. Crea una iluminación discreta que respeta la comodidad del usuario y no causa deslumbramiento.



EFICIENCIA

Hasta **105 lm output/W**.



CIRCULARIDAD

Concebido bajo criterio 3R:

Reducción de materiales: gracias a su miniaturización.

Reutilización: incorporando materiales reciclados de origen postindustrial.

Reciclable: concebido para mejorar su separabilidad y reciclabilidad al final de su ciclo de vida, y facilidad de mantenimiento.



DECLARACIONES AMBIENTALES DE PRODUCTO

En base UNE 15804.

Cuantifica el impacto en la huella de carbono considerando toda la vida del producto. Facilitando la información para el ACV (Análisis de Ciclo de Vida) del edificio.

Fil 35

*“La reinención conceptual de un clásico:
expresión lumínica”*

La miniaturización de esta familia mantiene su linealidad, trasladando esta solución lumínica a espacios sumamente exigentes desde un punto de vista formal, logrando una total integración en ellos. Fil 35 es la estructura que integra la máxima tecnología en el mínimo volumen.

Design by Lamp

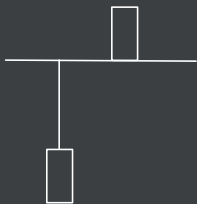



Miniaturización

La miniaturización de esta familia de productos permite dar una solución lumínica para espacios altamente exigentes en términos de requisitos de formalidad, respetando y permitiendo una buena integración con su entorno. Fil 35 es la estructura que se ajusta a la tecnología máxima dentro del volumen mínimo.

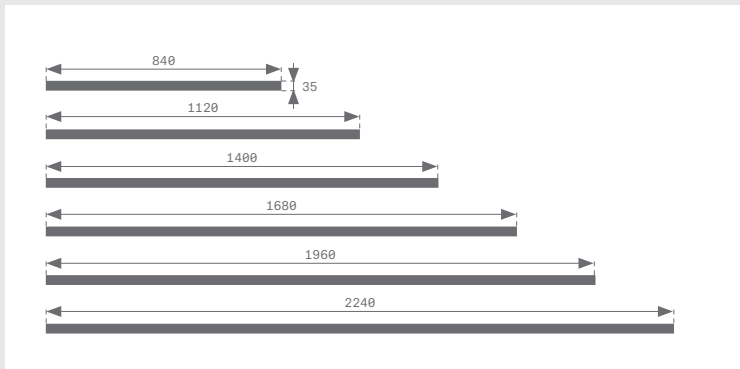

Gran variedad de longitudes

Es una familia de luminarias lineales con una amplia gama de longitudes, disponibles seis dimensiones estandarizadas y posibilidad de customizar longitudes especiales. Gracias a la miniaturización de las dimensiones de su perfil permite una alta integración del producto en el espacio.

Lamp Worktitude for light



Codos horizontales y verticales para configuraciones 3D

Está disponible para instalaciones de superficie, empotradas y empotradas sin molduras, y con acabados en negro, blanco o gris mate. También hay corners de 90° diseñados para poder instalarse tanto en dirección horizontal como en vertical, permitiendo realizar configuraciones 3D.

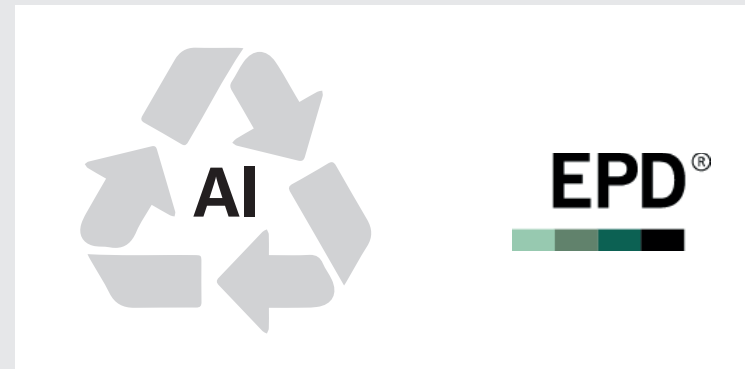

#Worktitude For Life

Fabricado en aluminio de extrusión reciclado en una tasa de 80-85%, reduciendo así la huella de carbono y el impacto ambiental.



+ INFORMACIÓN TÉCNICA

Ind.



Modelos	OPAL		OPAL COMFORT		TECH		DIRECT / INDIRECT		
Dimensiones	SURFACE		RECESSED		TRIMLESS		DIRECT / INDIRECT		
Lm LED	1200 lm	1470 lm	1600 lm	2000 lm	2400 lm	2650 lm	2800 lm	3200 lm	
Longitudes	840 mm	1120 mm	1400 mm	1680 mm	1960 mm	2240mm			
IRC	80 / 90								
Ángulos apertura	Opal		Opal Comfort		Tech		Dir / Ind		
Temp. Color	3000 / 4000 K								
Equipo	ON/OFF - DALI								
Potencia	8 W	11 W	12 W	14 W	16 W	18 W	19 W	22 W	32 W
Acabados Acc.	● Negro 02		○ Blanco 02		● Gris 01				



Fil 45

*“La evolución funcional de un clásico:
vocación de dar respuestas”*

Manteniendo la atemporalidad de la familia, Fil se amplía reduciendo sus dimensiones e incrementando sus posibilidades. La vocación de Fil 45 es aportar una iluminación general de calidad capaz de adaptarse a cualquier espacio y dar respuesta a las altas exigencias lumínicas que un proyecto pueda requerir.

Design by Lamp

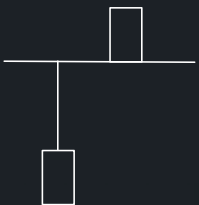



+ INFORMACIÓN TÉCNICA

Ind.



Variedad de distribuciones lumínicas

Posibilidad de elegir entre difusor Opal, Opal Comfort y Tech Ultracomfort según los requerimientos lumínicos de cada aplicación. **La opción Tech Ultracomfort**, además ofrece dos distribuciones lumínicas, mediante un reflector negro de policarbonato con una óptica simétrica (TE) o asimétrica (TA).



Comfort visual

Dos soluciones con distribuciones lumínicas optimizadas para aportar comfort visual:

- **Opal Comfort**, manteniendo una estética opalina uniforme, incorpora de una lámina técnica, aportando un mayor control lumínico (UGR<16)
- **Tech UltraComfort**, óptica combinada para ofrecer un control del deslumbramiento activo (UGR<15).
Efecto Dark light: satisface los requisitos del límite de oscuridad (emisión inferior a 200cd/lm por encima de un ángulo de visión de 60°).
Alta eficiencia lumínica real (105lm/W).



Iluminación funcional y ambiental integrada

Iluminación directa e indirecta integrada en una misma luminaria: doble efecto lumínico para la instalación en suspensión. Diseño pensado para espacios en los que se quiera resaltar los techos o conseguir una menor fatiga visual, como en espacios de trabajo y oficinas, **evitando los altos contrastes y deslumbramientos.**



#WorktitudeForLife, evaluación del impacto ambiental

Fabricado en aluminio de extrusión reciclado en una tasa de 80-85%, reduciendo así la huella de carbono y el impacto ambiental. La familia Fil ha sido diseñada teniendo en cuenta en ACV (Análisis de Ciclo de Vida), y cuenta con EPD.

Descarga:



+ INFORMACIÓN TÉCNICA

Ind.

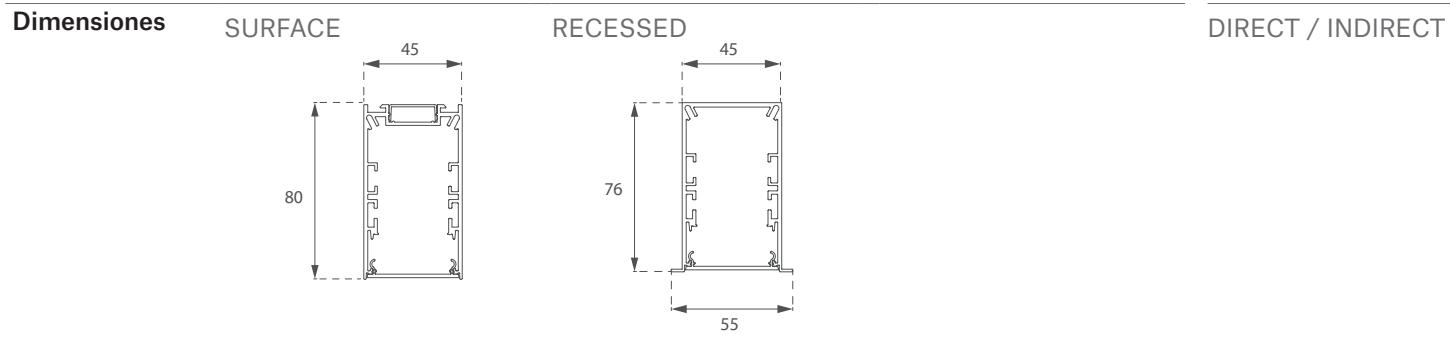

Lm LED	1450 lm	2600 lm	3250 lm	3900 lm	4550 lm	3200 lm
	4650 lm	6200 lm	7750 lm	9300 lm	10850 lm	12400 lm
Longitudes	840 mm	1120 mm	1400 mm	1680 mm	1960 mm	2240mm

IRC 80 / 90

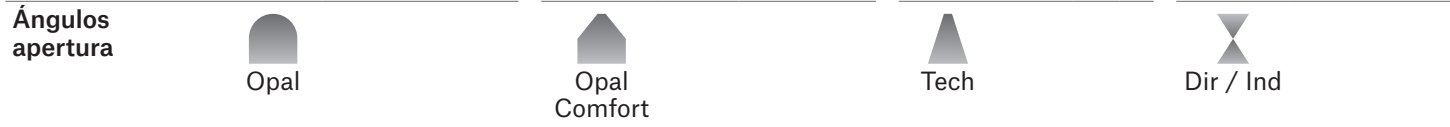

Temp. Color 3000 / 4000 K / TW / WB

Equipo ON/OFF - DALI

Potencia	12 W	16 W	19 W	23 W	27 W	31 W
	27 W	36 W	45 W	54 W	63 W	72 W

Acabados Acc. ● Negro 02 ○ Blanco 02 ● Gris 01



+ INFORMACIÓN TÉCNICA

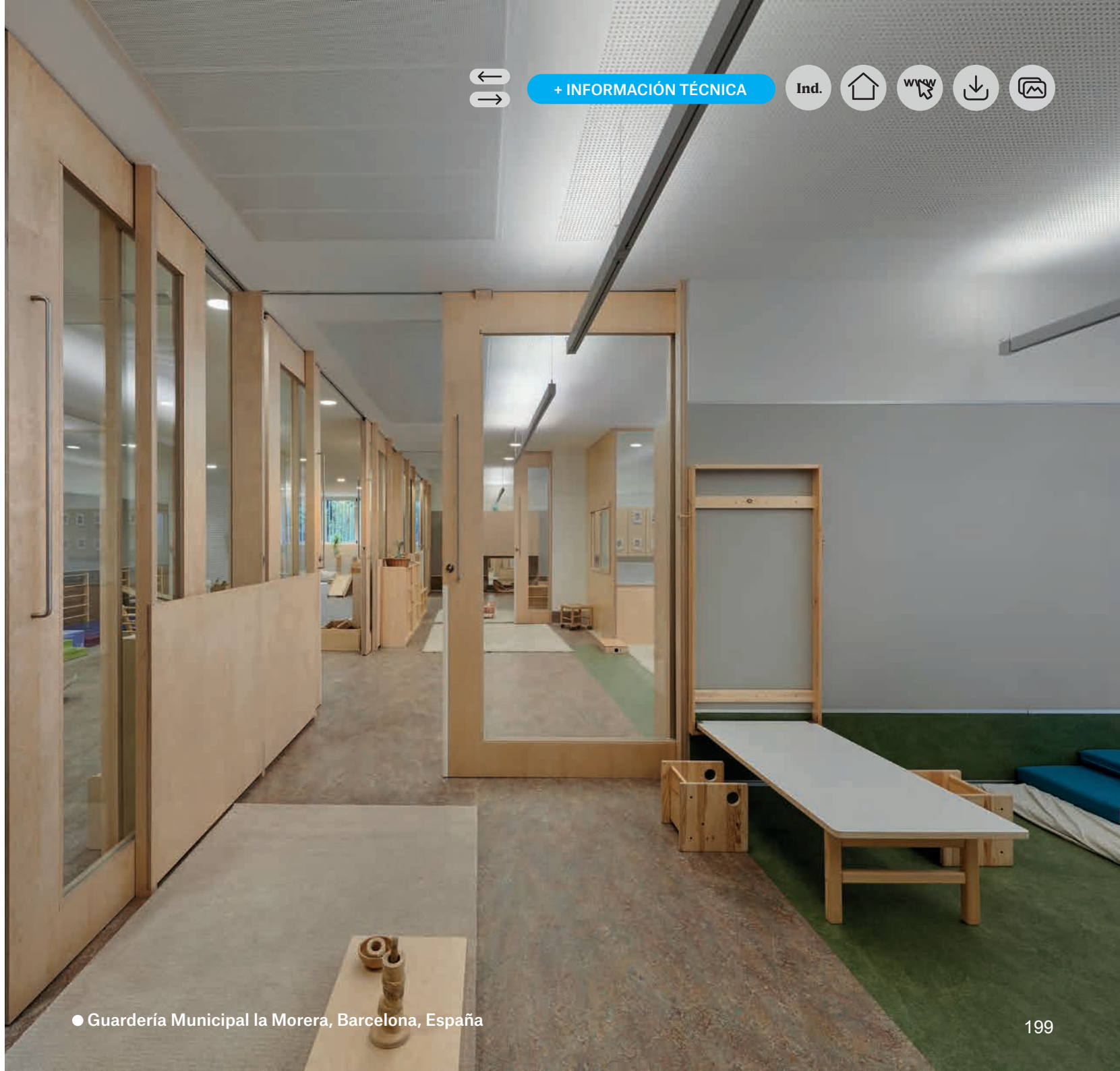



+ INFORMACIÓN TÉCNICA

Ind.

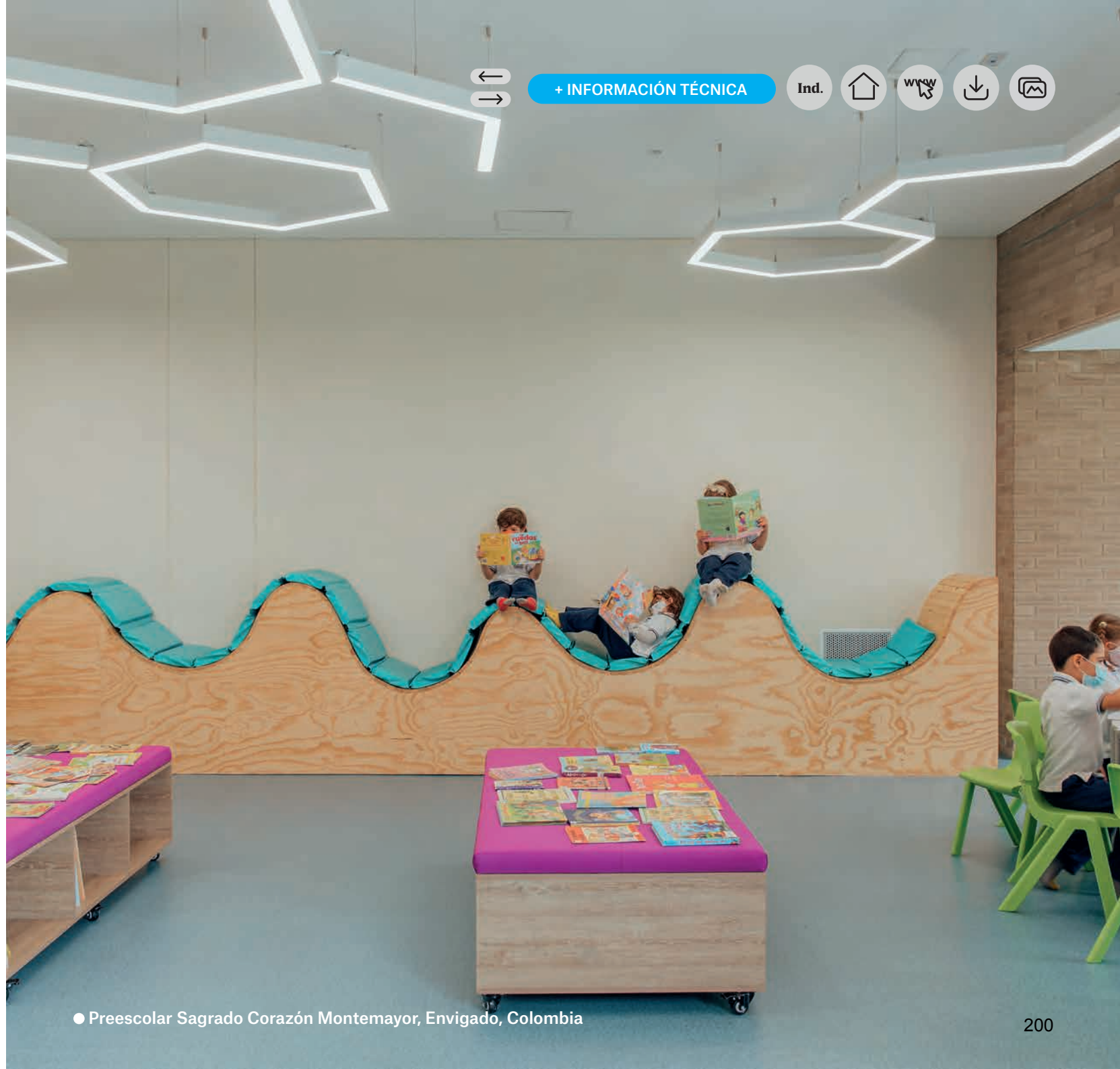



Fil 50

“Integración en cualquier espacio interior”

Fil 50 es una familia de estructuras caracterizada por su diseño neutro, minimalista y atemporal. Estas cualidades y su amplitud de gama te permitirán, sin duda, una infinidad de aplicaciones en todo tipo de espacios interiores.

Design by Lamp

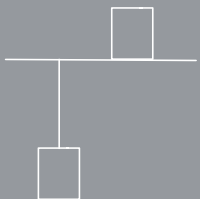

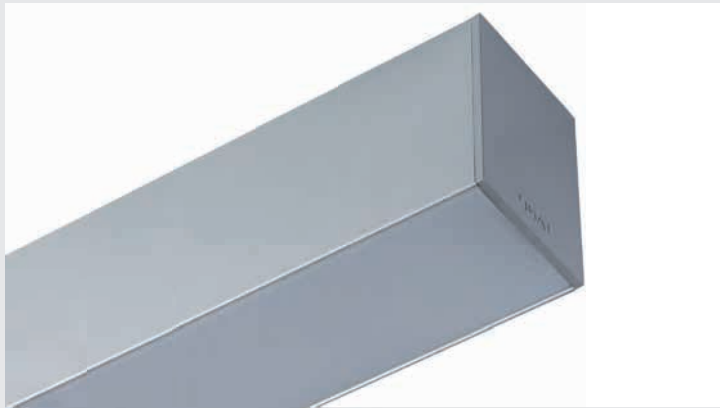

Versatilidad en espacios

Familia de estructuras caracterizada por su diseño neutro, minimalista y atemporal. Estas cualidades y su amplitud de gama te permitirán, sin duda, una infinidad de aplicaciones en todo tipo de espacios interiores.

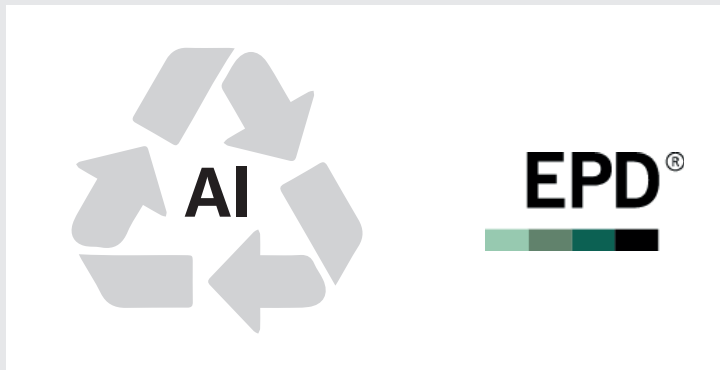

#Worktitude For Life

Fabricado en aluminio de extrusión reciclado en una tasa de 80-85%, reduciendo así la huella de carbono y el impacto ambiental.

Geometrías configurables

Sistema lineal que permite configurar lineales continuos a través de uniones y también realizar geometrías especiales mediante corners de 90°. Disponibilidad bajo pedido de diferentes ángulos no inferiores de 60°.

Slim para techos técnicos

Fil 50 dispone de una opción Slim para insertar las luminarias entre lamas o bien en sustitución de una de ellas, para una iluminación general de máxima calidad. Se adapta en cuanto a confort, tecnología e instalación. Instalación mediante accesorio para ubicar las luminarias entre 2 lamas, dependiendo de la distancia a mantener entre lama y luminaria.

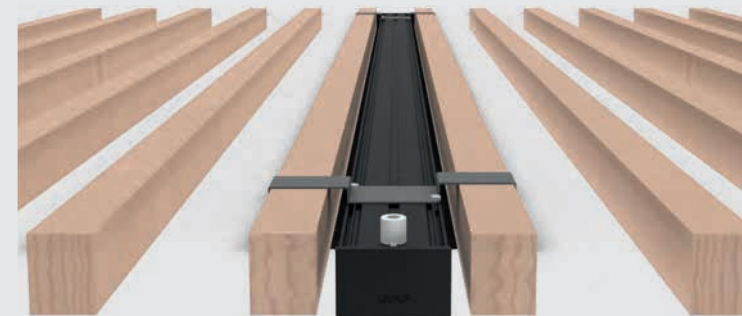



+ INFORMACIÓN TÉCNICA

Ind.

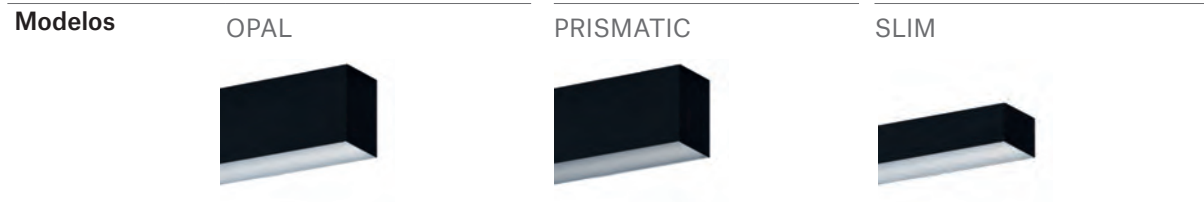

Dimensiones

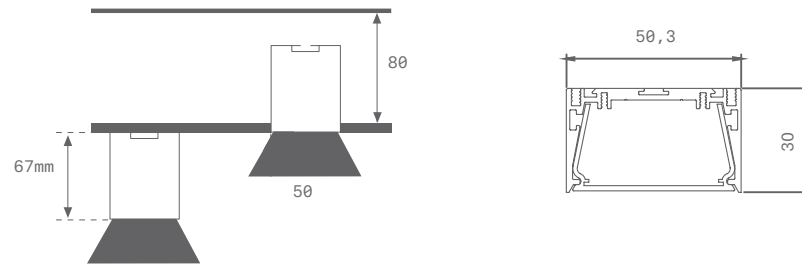

Longitudes	1123 mm	1683 mm
Lm LED	3000 lm 6000 lm	4600 lm 9200 lm
IRC	80	
Ángulos apertura	 Opal	 Prismatic
Temp. Color	3000 / 4000 K	
Equipo	ON/OFF - DALI	
Potencia	21 W 40 W	31 W 59 W
Acabados	<input type="radio"/> Blanco 02	<input checked="" type="radio"/> Gris 01

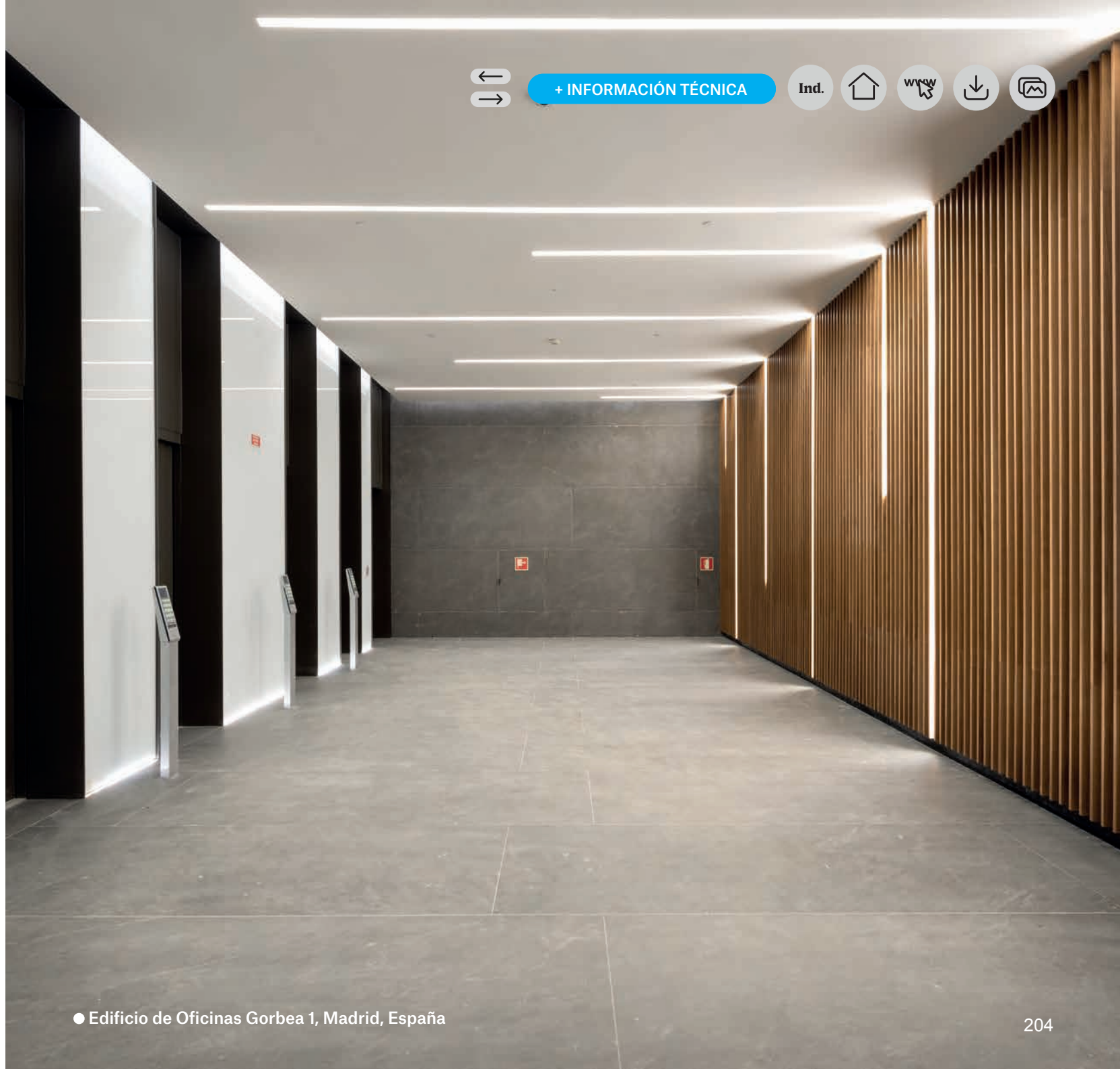

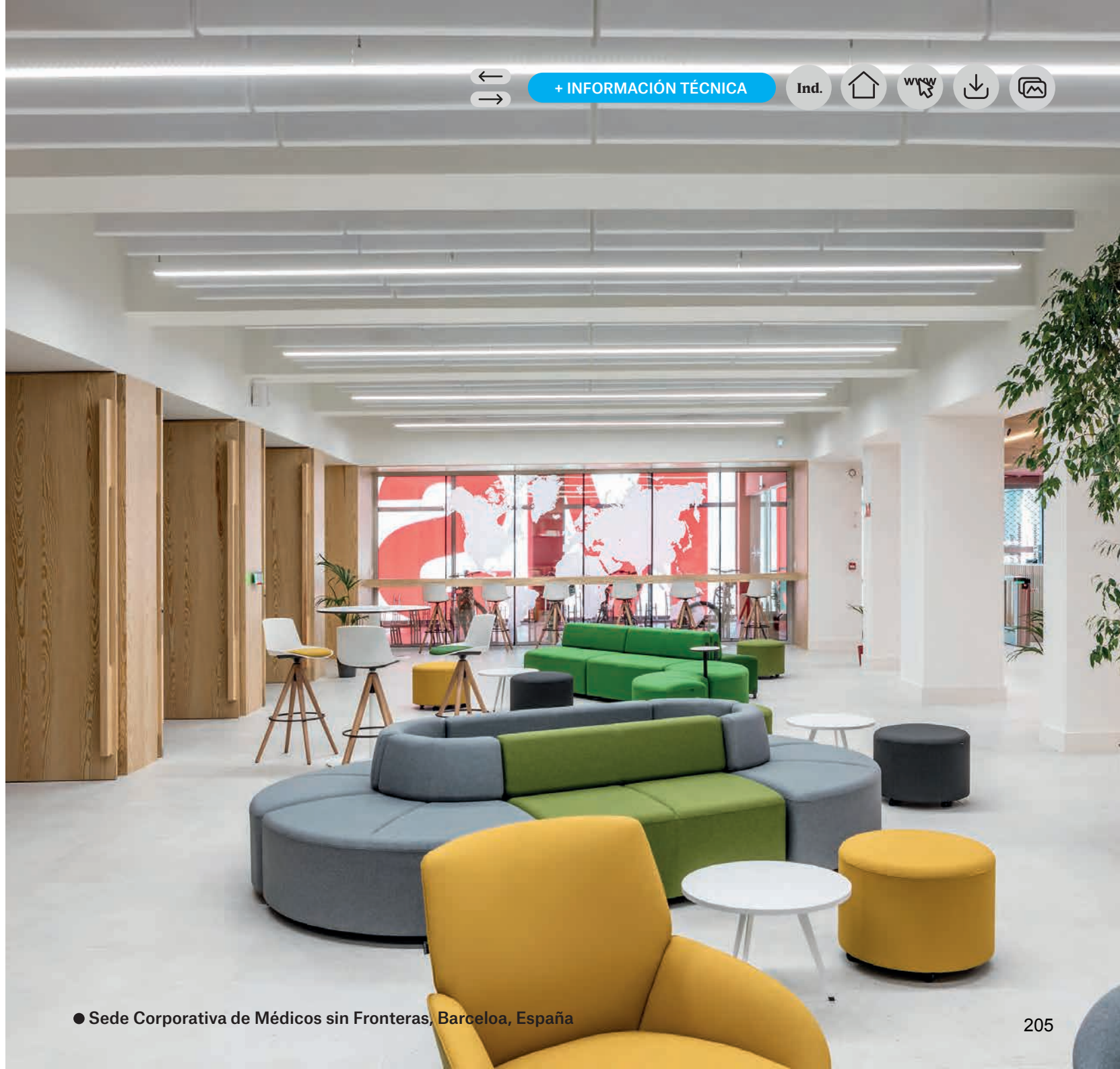



Ind.

Fil 70

“Versatilidad expresada como estructura”

Cuando una luminaria se adapta a cualquier espacio has conseguido atribuir a ese producto una de las características que le darán más valor: la polivalencia. Con un diseño minimalista Fil 70 cubre una amplia gama de aplicaciones con propuestas de luz directa e indirecta, modelos de bajo deslumbramiento, distribuciones asimétricas y distintas posibilidades de instalación.

Design by Lamp

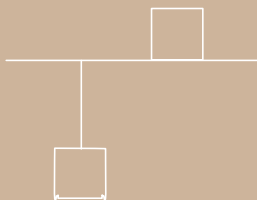



+ INFORMACIÓN TÉCNICA

Ind.



Control lumínico

La gama Fil 70 tiene un amplio abanico de soluciones ópticas, como por ejemplo la versión tech y la distribución asimétrica de la luz.



Geometrías configurables

Sistema lineal que permite configurar lineales continuos a través de uniones y también realizar geometrías especiales mediante corners en forma de L a 90°.

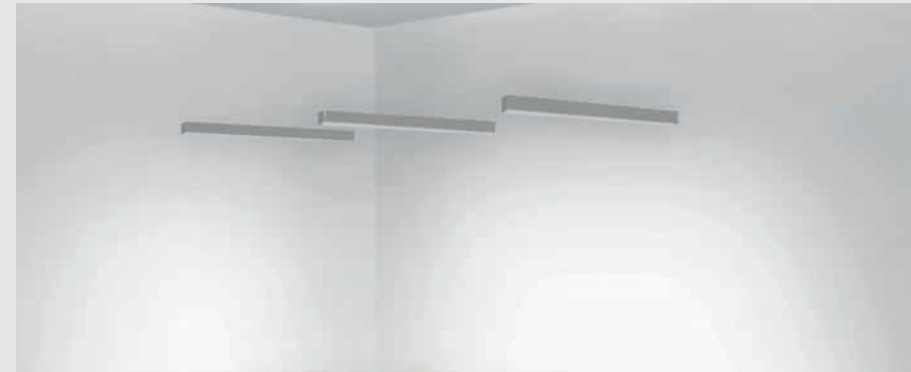

Iluminación funcional y ambiental

Iluminación directa e indirecta integrada en una misma luminaria consiguiendo un doble efecto lumínico para la instalación de Fil en suspensión. Diseño pensado para espacios en los que se quiera resaltar los techos o conseguir una menor fatiga visual, como por ejemplo en espacios de trabajo y oficinas, evitando los altos contrastes y deslumbramientos.

Riesgo Fotobiológico



Nuestra familia Fil está clasificada dentro del "Grupo 0" de riesgo fotobiológico, y por tanto está totalmente exenta de riesgo. La aplicación de este tipo de productos es sumamente importante en determinadas aplicaciones, donde los usuarios están mucho tiempo expuestos a la iluminación artificial, o en espacios dónde los usuarios principales poseen una alta sensibilidad a la luz.

#Worktitude For Life



Fabricado en aluminio de extrusión reciclado en una tasa de 80-85%, reduciendo así la huella de carbono y el impacto ambiental.



+ INFORMACIÓN TÉCNICA

Ind.



Modelos	OPAL		PRISMATIC		DIRECT / INDIRECT		TECH / TECH ASYMMETRIC			
Dimensiones	SURFACE		RECESSED		SURFACE		SURFACE		RECESSED	
Longitudes	1162 mm		1743 mm				1000 mm		2000 mm	
Lm LED	2600 lm 4400 lm		3900 lm 6600 lm				1600 lm 3200 lm		3200 lm 6400 lm	
IRC	80									
Ángulos apertura										
	Opal		Prismatic		Opal		Tech		Tech Asym.	
Temp. Color	3000 / 4000 K									
Equipo	ON/OFF - DALI									
Potencia	17 W 28 W		25 W 41 W				12 W 21 W		25 W 42 W	
Acabados	○ Blanco 02		● Gris 01							



+ INFORMACIÓN TÉCNICA

Ind.

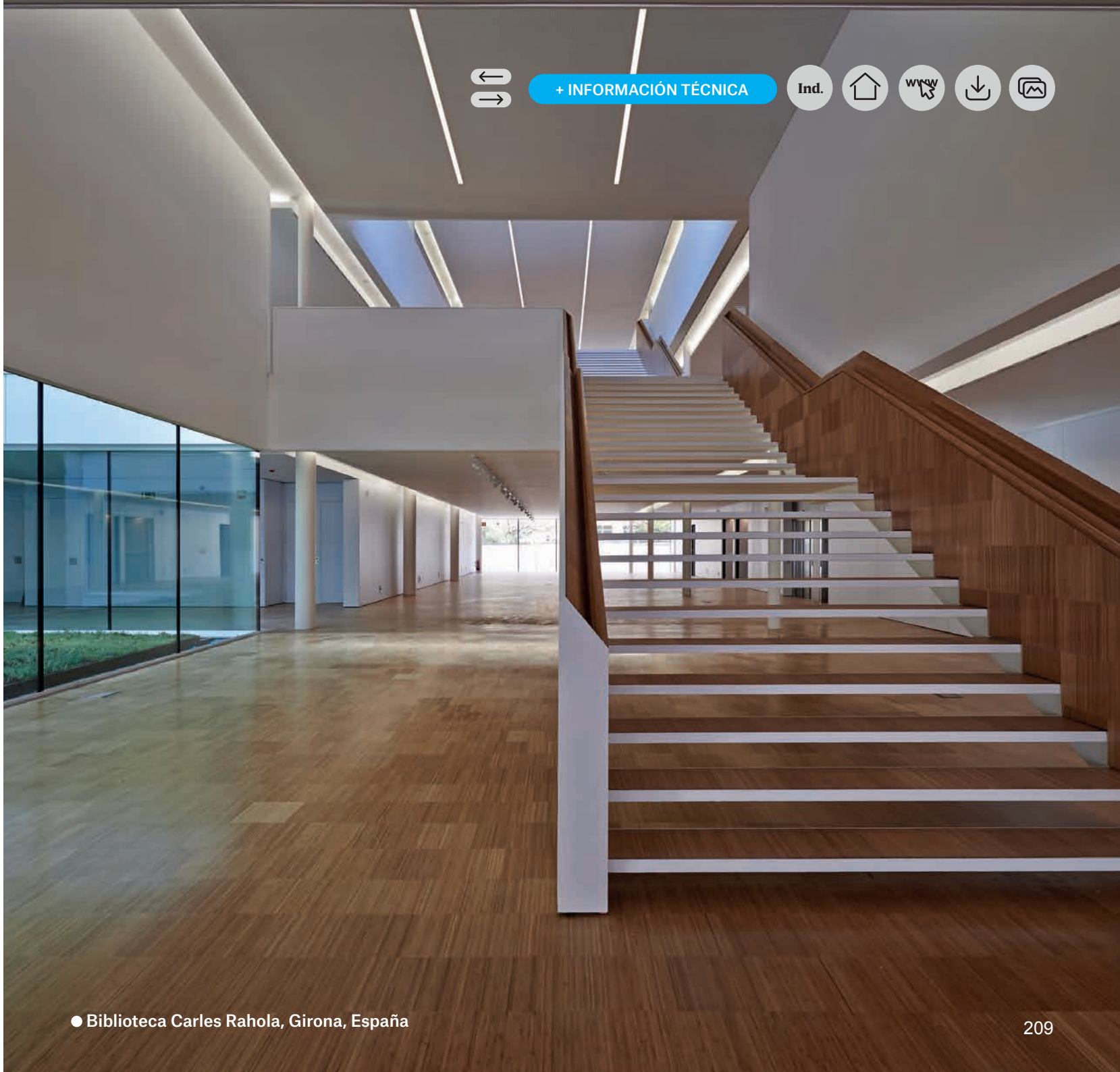



+ INFORMACIÓN TÉCNICA

Ind.

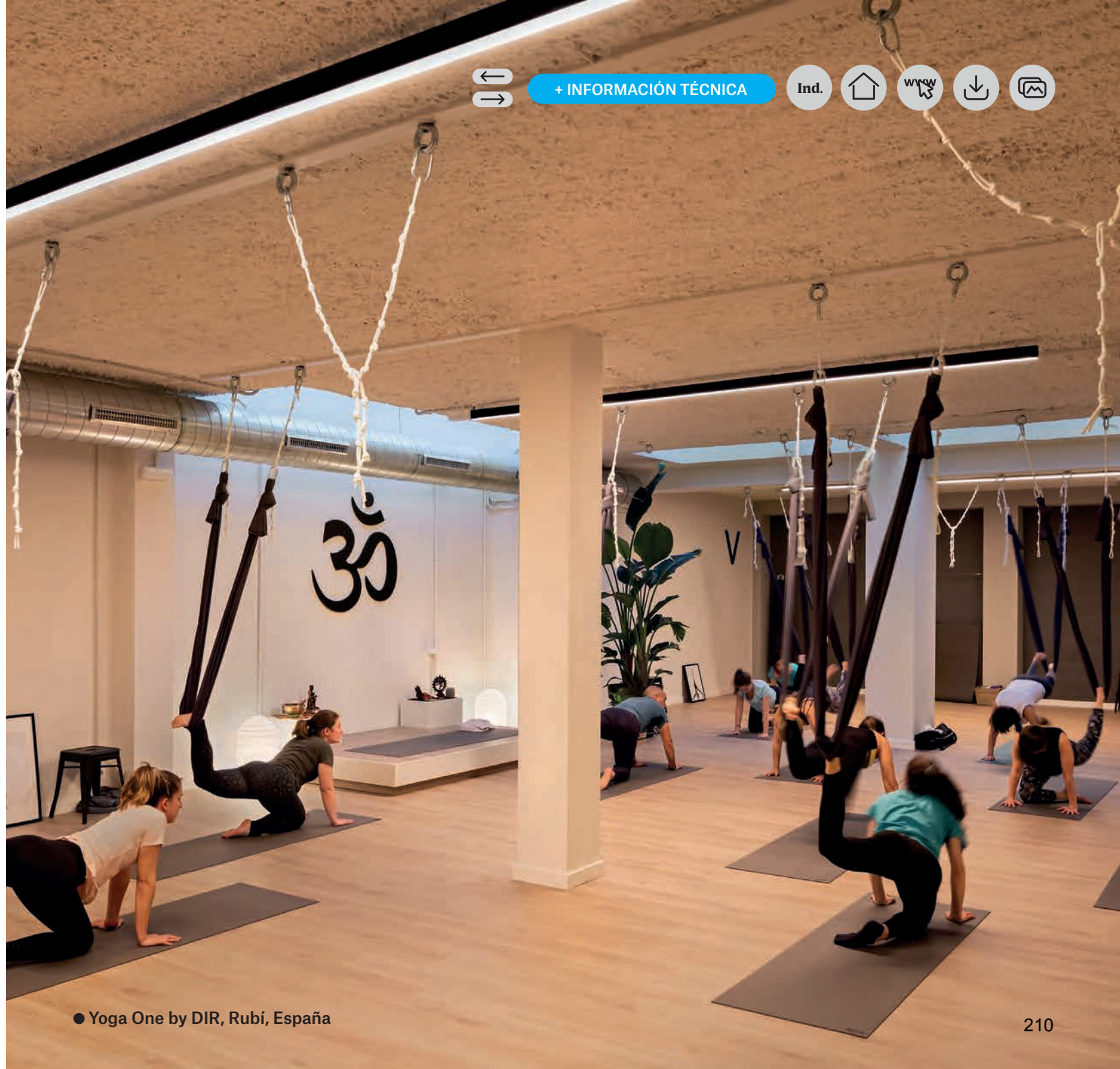



Lamptub 60

“La luminaria más adaptable a los espacios en constante evolución”

La expresión renovada de un clásico que se adapta a las necesidades de espacios exigentes en constante evolución, gracias a su versatilidad lumínica y a sus múltiples opciones de instalación.

Design by Lamp





+ INFORMACIÓN TÉCNICA

Ind.



Confort visual Lamptub 60 Tech

Luminaria clasificada como "exenta de riesgo" RG0 según la normativa de Riesgo Fotobiológico UNE 62471. Difusor opal y opal confort. Disponible en modelos con difusor opal confort para un control de la distribución lumínica y deslumbramiento inferior UGR19. Versiones de máximo confort visual disponible en modelos de bajo flujo lumínico (versiones LO) con UGR inferior a 15.



Versatilidad

Diferentes distribuciones lumínicas, directa y directa e indirecta. Temperaturas de color disponibles: 2700K, 3000K y 4000K con CRI 90 o Blanco dinámico (2700-6500K).



Iluminación flexible

Múltiples posibilidades de instalación: track superficie o suspendido para integración en Sistema NOMADIC, suspendido con fión empotrado o en superficie

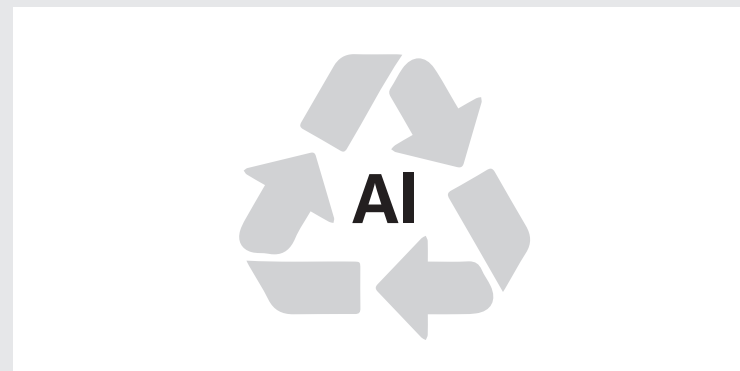

Sostenibilidad

Diseñado bajo un concepto de economía circular que facilita la recuperación y reutilización de las luminarias. Fabricado en aluminio de extrusión reciclado.

Lamptub 60 | Indoor



+ INFORMACIÓN TÉCNICA

Ind.



Modelos	SUS. DIR. REC	SUSP. DIR. SUR	TECH	SUS. DIR/IND. REC	TRACK DIR. SUR	TRACK DIR. SUS	TRACK DIR/IND. SUS		
Dimensiones	DIRECT	DIRECT / INDIRECT		DIRECT	DIRECT / INDIRECT				
Longitudes	840mm	1120mm	1680mm						
Lm LED	1500lm	2600lm	3000lm						
IRC	90								
Ángulos apertura	Opal	Opal Comfort	Tech	Dir/Ind Opal	Dir/Ind Opal Comfort	Opal	Opal Comfort	Dir/Ind Opal	Dir/Ind Opal Comfort
Temp. Color	2700 / 3000 / 4000 K/TW				2700 / 3000 / 4000 K				
Equipo	ON/OFF - DALI								
Potencia									
Acabados	○ Blanco ● Negro								
Paletas Wellbeing	● 4050-R90	○ 1505-Y10R	● 7024	● 4030-B50G	● 7001				
Paletas Be Social	● 4050-R90	● 1050-B10G	● 7502-R	● 7502-R	● 2011				

TECH ULTRACOMFORT

Design by Lamp

LAMPTUB 60





Lamptub 60



+ INFORMACIÓN TÉCNICA

Ind.



Confort y bienestar



SALUD VISUAL

UGR 12

Control del deslumbramiento activo a través de la óptica **TECH ULTRACOMFORT**.

Flicker free.



MATERIALIDAD

Reducción del 40% de la huella de CO₂ en la fabricación gracias al uso de aluminio reciclado.



EFICIENCIA

Hasta **99 lm output/W**.



CIRCULARIDAD

Concebido bajo criterio 3R:

Reducción de materiales: gracias a su miniaturización.

Reutilización: incorporando materiales reciclados de origen postindustrial.

Reciclable: concebido para mejorar su separabilidad y reciclabilidad al final de su ciclo de vida, y facilidad de mantenimiento.



DECLARACIONES AMBIENTALES DE PRODUCTO

En base UNE 15804.

Cuantifica el impacto en la huella de carbono considerando toda la vida del producto. Facilitando la información para el ACV (Análisis de Ciclo de Vida) del edificio.

Lamptub 60



+ INFORMACIÓN TÉCNICA

Ind.



NS Nomadic System

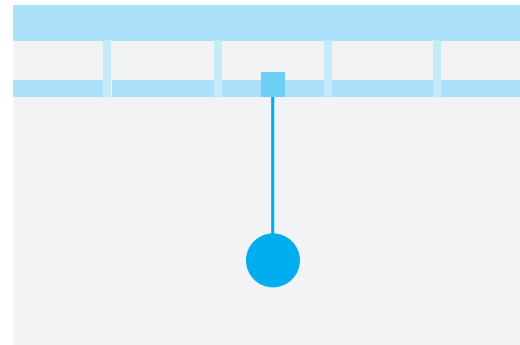

Espacios con instalaciones ocultas (falso techo continuo).

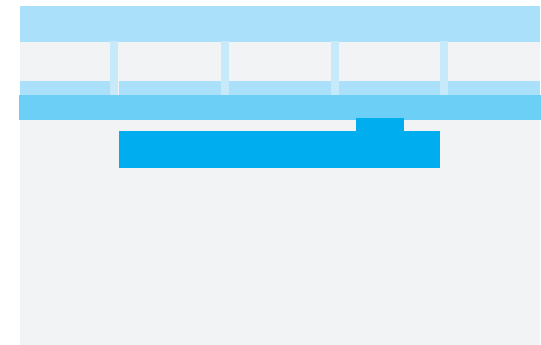

Espacios con instalaciones ocultas (bandeja metálica registrable).

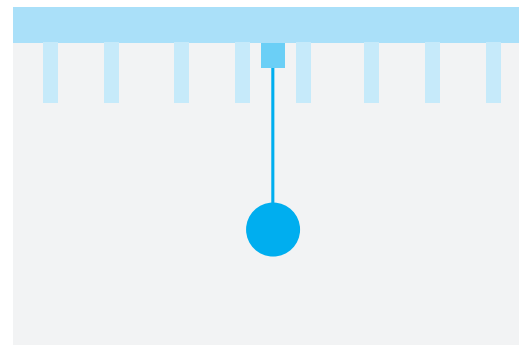

Espacios con instalaciones vistas (falso techo de lamas).

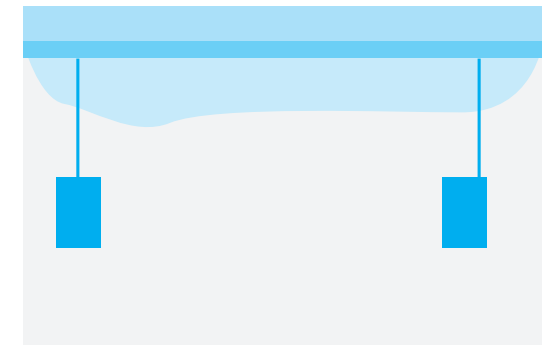

Espacios con instalaciones vistas (techos multiformato).





+ INFORMACIÓN TÉCNICA

Ind.



Modelos	SUS. DIR. REC	SUSP. DIR. SUR	TECH	SUS. DIR/IND. REC	TRACK DIR. SUR	TRACK DIR. SUS	TRACK DIR/IND. SUS		
Dimensiones	DIRECT			DIRECT / INDIRECT		DIRECT / INDIRECT			
Longitudes	840mm	1120mm	1680mm						
Lm LED	1500lm	2600lm	3000lm						
IRC	90								
Ángulos apertura									
Temp. Color	2700 / 3000 / 4000 K/TW				2700 / 3000 / 4000 K				
Equipo	ON/OFF - DALI								
Potencia	10 W	12 W	17 W						
Acabados	○ Blanco ● Negro								
Paletas Wellbeing	● 4050-R90	○ 1505-Y10R	● 7024	● 4030-B50G	● 7001				
Paletas Be Social	● 4050-R90	● 1050-B10G	● 7502-R	● 7502-R	● 2011				

Lamptub 60



+ INFORMACIÓN TÉCNICA





Lamptub 80

“Un clásico de Lamp reinventado”

Si buscáramos entre los productos más representativos de Lamp sin duda encontraríamos a Lamptub, un producto que nació hace más de 25 años. Este producto de iluminación general, ha pasado de ser un básico a un clásico, adaptado a las nuevas tecnologías.

Design by Lamp



Lamptub 80

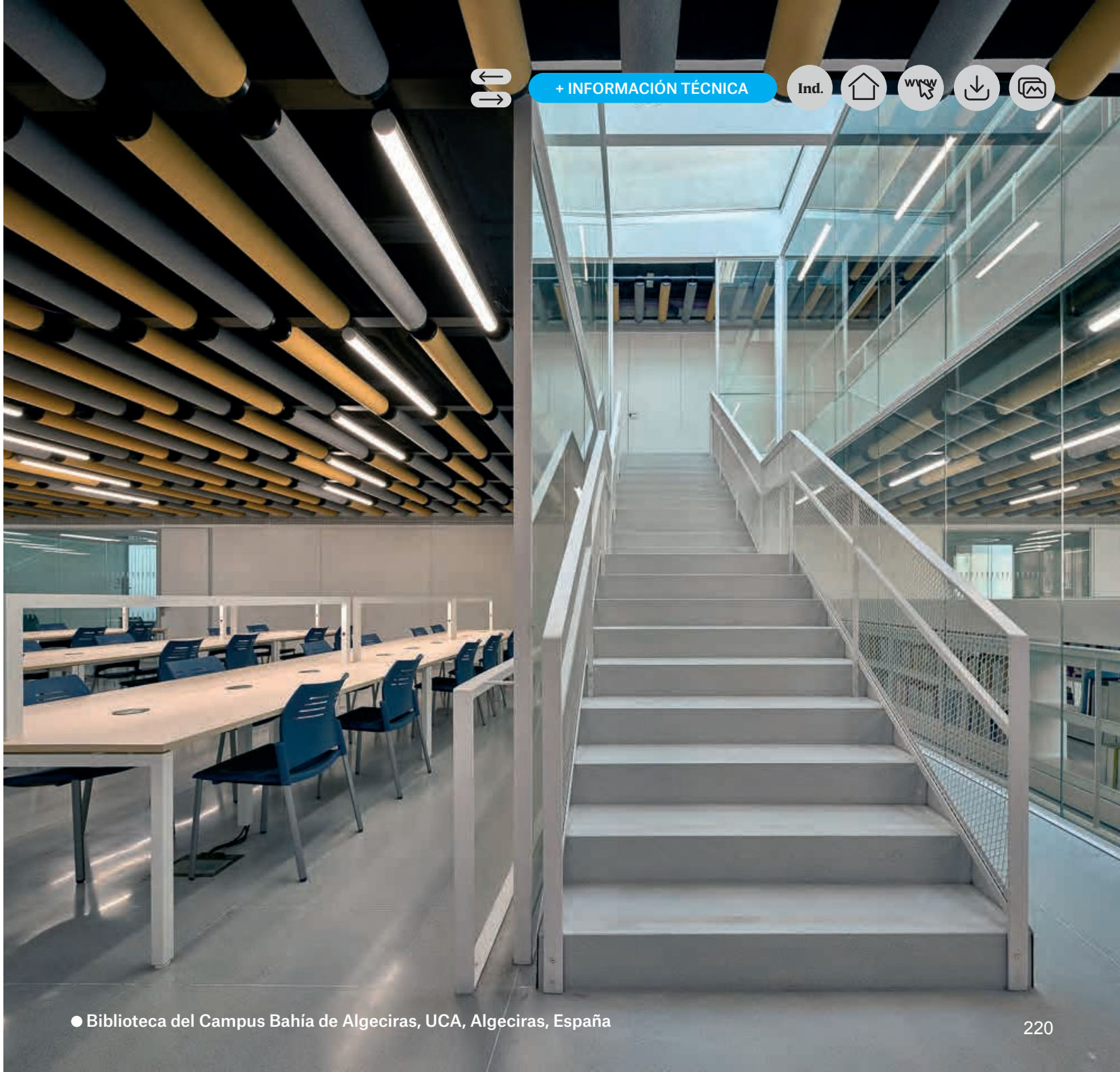

+ INFORMACIÓN TÉCNICA



Health Solutions: Clinic & Clinic Gas

Familia de cabezales de hospital de diseño neutro y minimalista ideal para integrarse en el espacio cediendo todo el protagonismo a la luz.

Clinic y Clinic Gas son luminarias personalizables según las necesidades de cada proyecto, con posibilidad de iluminación directa, indirecta y de exploración, así como con gran variedad de mecanismos que quedan siempre integrados en la parte superior o inferior del perfil de tal manera que quedan ocultos. El modelo Clinic Gas, además nos permite alojar las tomas de gases medicinales en un canal independiente, hecho que nos proporciona gran accesibilidad y usabilidad. Esta familia de cabezales está pensada tanto para hospitales y mutuas, como residencias y centros de salud.

Design by Lamp





+ INFORMACIÓN TÉCNICA

Ind.

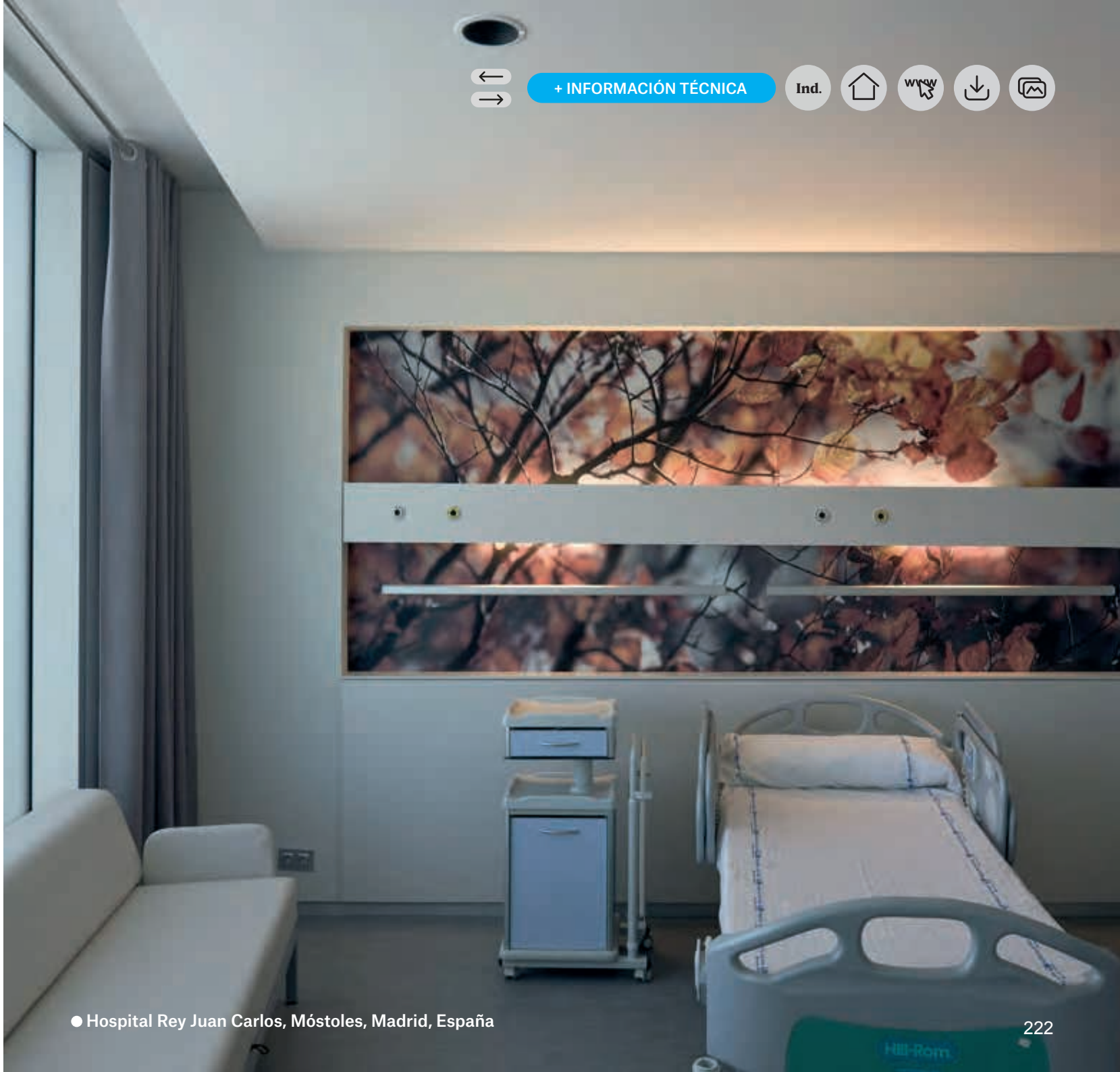

Transport Solutions

Pensadas específicamente para instalarse en zonas acondicionadas al tránsito peatonal tales como estaciones de transporte público.

Fabricadas en extrusión de aluminio, son estructuras robustas pero flexibles, con posibilidad de integrar emergencias, altavoces y conducciones eléctricas de baja tensión, separadas entre ellas por distintas canalizaciones en el interior de la luminaria.

Al igual que para las luminarias desarrolladas para el metro de Santiago de Chile, Barcelona y Toulouse, se pueden realizar luminarias similares según las necesidades del proyecto.

Design by Lamp

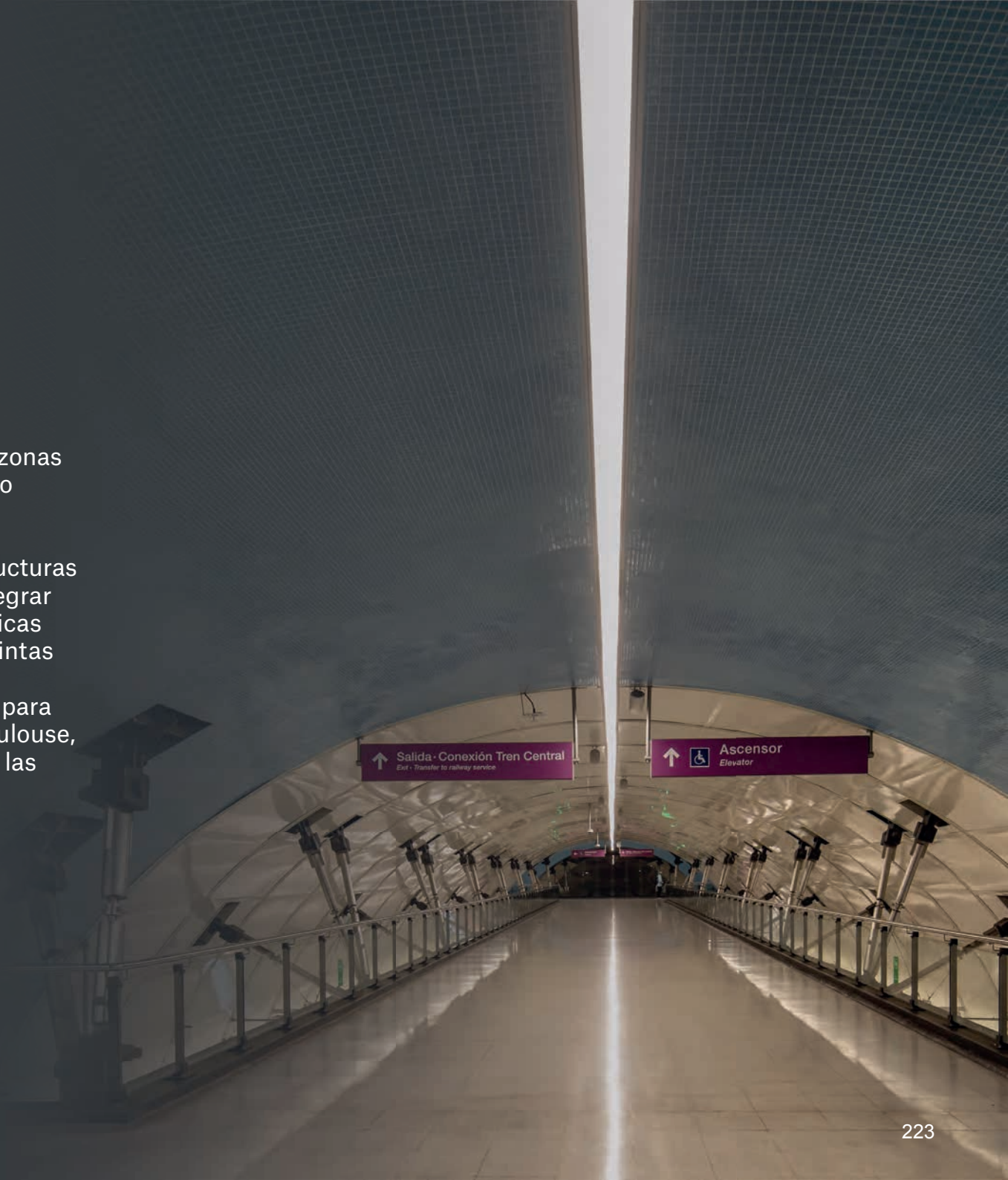
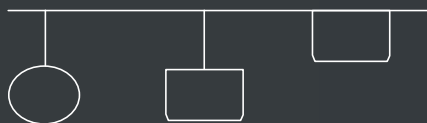

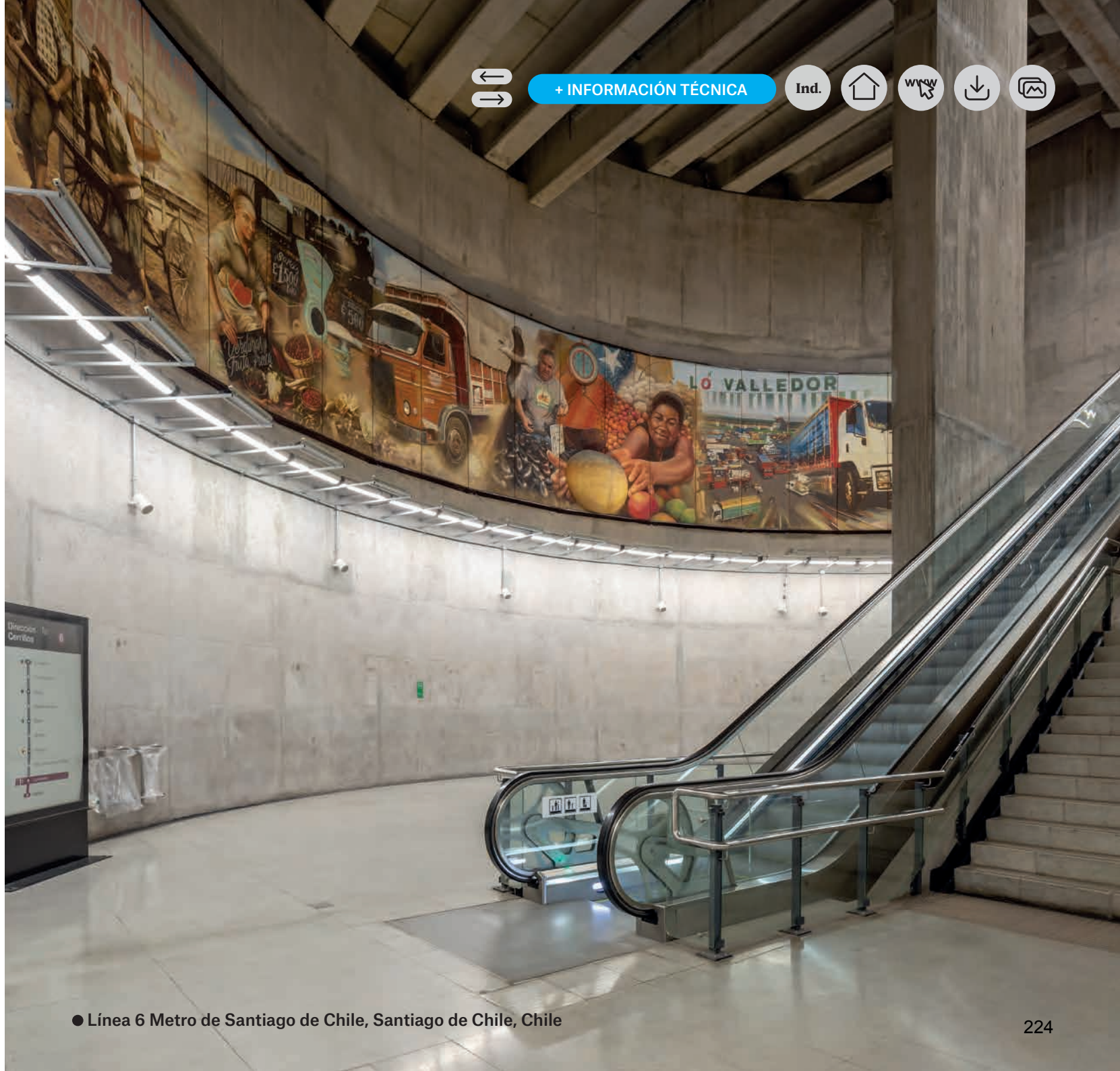

+ INFORMACIÓN TÉCNICA



Seti

“Más que una escultura”

Más que una baliza de exterior, Seti es un sistema de iluminación que se desarrolla verticalmente y que está conceptualizado con el objetivo de cubrir infinidad de posibilidades constructivas y formatos de iluminación.

Design by Antoni Arola

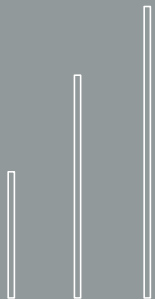



Elegancia formal

Dimensiones reducidas a la mínima expresión, diseño esbelto con una sección de 39mm x 120mm.

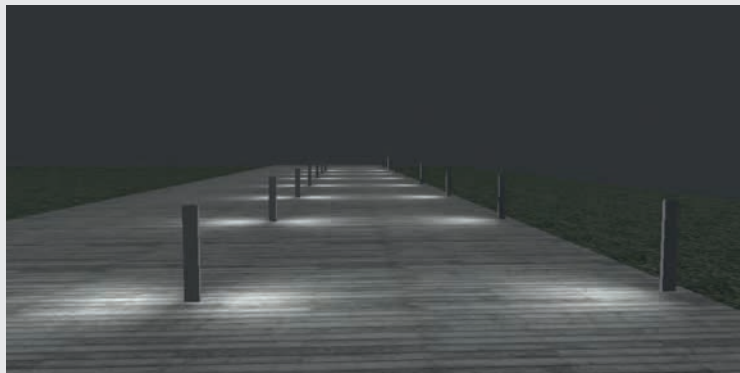

Versatilidad de los efectos lumínicos

Dos aplicaciones lumínicas

Individual: ilumina el plano horizontal de forma unidireccional.

Doble: ilumina el plano horizontal de forma bidireccional.

Dos opciones de óptica

Spot: ilumina en la superficie horizontal con un alto contraste en la superficie iluminada y la no iluminada

Soft: toma presencia el producto y genera una luz más difuminada en la superficie horizontal.

Lamp Worktitude for light

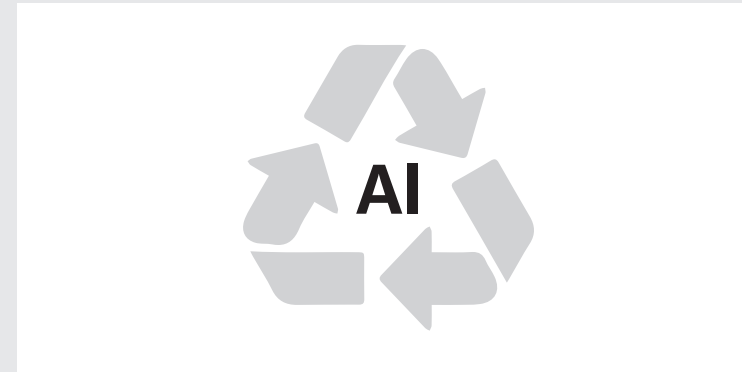

#Worktitude For Life

Fabricado en aluminio de extrusión reciclado en una tasa de 80-85%, reduciendo así la huella de carbono y el impacto ambiental.



Variedad de acabados

Diferentes acabados y combinaciones con blanco-negro, y antracito-negro. Acabado del producto diferente en la parte interna y externa, que genera una diferenciación en la percepción de los distintos planos. Posibilidad de personalizar el color.



+ INFORMACIÓN TÉCNICA

Ind.

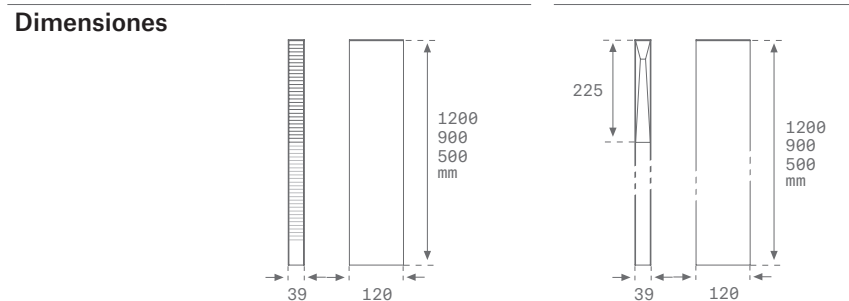

Lm LED 200 lm - 1000 lm

IRC 80



Temp. Color 3000 K

Equipo ON/OFF

Potencia 3 - 9 W

Acabados ● Antracita 01 ● Negro 03

Seti

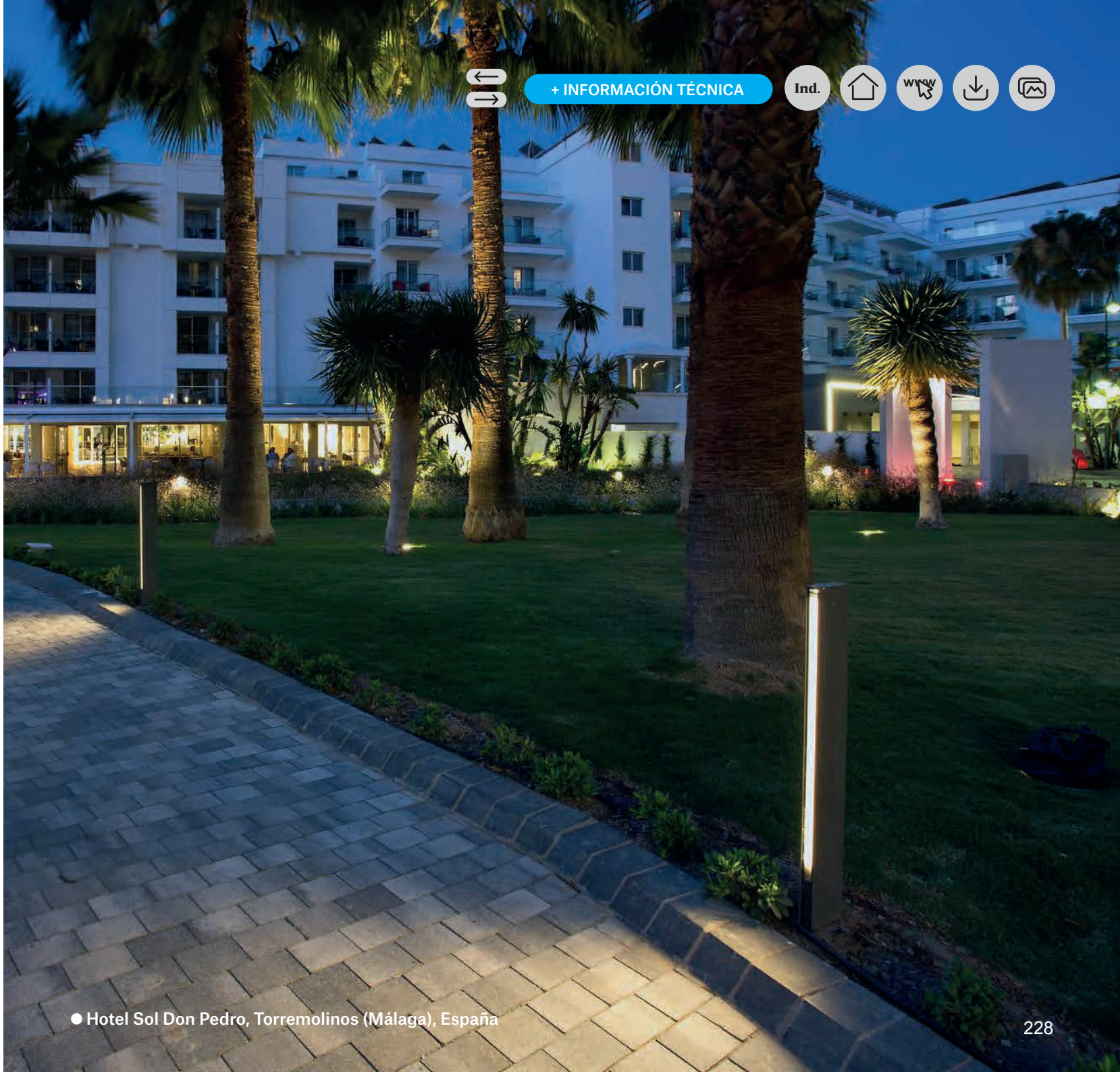

+ INFORMACIÓN TÉCNICA



B-Side

“Tecnologías disruptivas en diseño de producto”

Un concepto basado en la idea de que el propio objeto recoge la luz que genera, potenciando así el carácter del producto como elemento de señalización. El LED permite generar un diseño ligero y adaptado a la función, aportando valor estético y funcional.

Design by Lamp





+ INFORMACIÓN TÉCNICA

Ind.



Versatilidad de efectos lumínicos

La familia B-side permite la posibilidad de tener una baliza con iluminación bidireccional rasante a nivel del suelo, y también a distintas alturas para bañar las zonas exteriores de paso o recorridos. Además, existe la versión con efecto lumínico 360°.



Antivandálico y anticorrosivo

Su construcción robusta (IK10 e IP65) le otorga seguridad y solidez para espacios públicos, ya que su estructura permanece intacta ante cualquier golpe o ataque ajeno, lo que hace de B-Side LED una excelente solución antivandálica para iluminar parques públicos, jardines y diferentes zonas urbanas. fabricada en extrusión e inyección de aluminio, y lacado en polyester color gris texturizado. Su base lleva un tratamiento anticorrosivo, que le permite instalarse en cualquier tipo de superficie

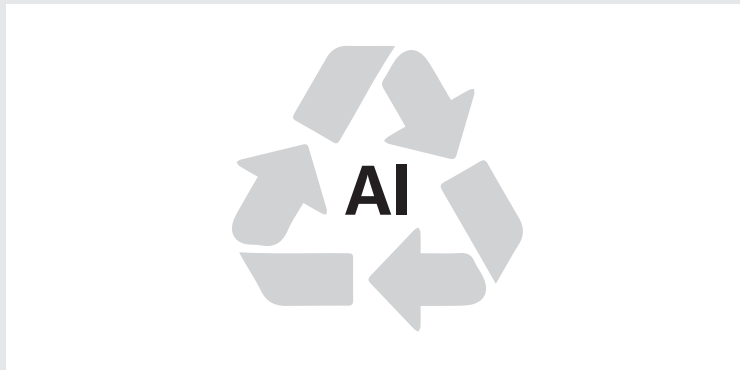

#Worktitude For Life

Fabricado en aluminio de extrusión reciclado en una tasa de 80-85%, reduciendo así la huella de carbono y el impacto ambiental.



Eficiencia mejorada

La segunda generación de balizas B-SIDE ha logrado un incremento del 45% en la eficiencia inicial. Los modelos B-Side 360° y 180° suponen una solución lumínica para zonas de paso exteriores, altamente eficiente, llegando hasta 65lm/W. Una iluminación excepcionalmente uniforme en tus espacios exteriores, al tiempo que reduces el consumo energético.



+ INFORMACIÓN TÉCNICA

Ind.



Modelos	B-SIDE	B-SIDE 360°	
			
Dimensiones			
Lm LED	93 lm - 171 lm	1200 lm - 1500 lm	
IRC	80		
Ángulos apertura	 Spot	 180°	 360°
Temp. Color	3000 - 4000 K		
Equipo	ON/OFF		
Potencia	2 - 4,8 W	6 - 9 W	
Acabados	● Antracita 01	● Gris 03	



+ INFORMACIÓN TÉCNICA

Ind.

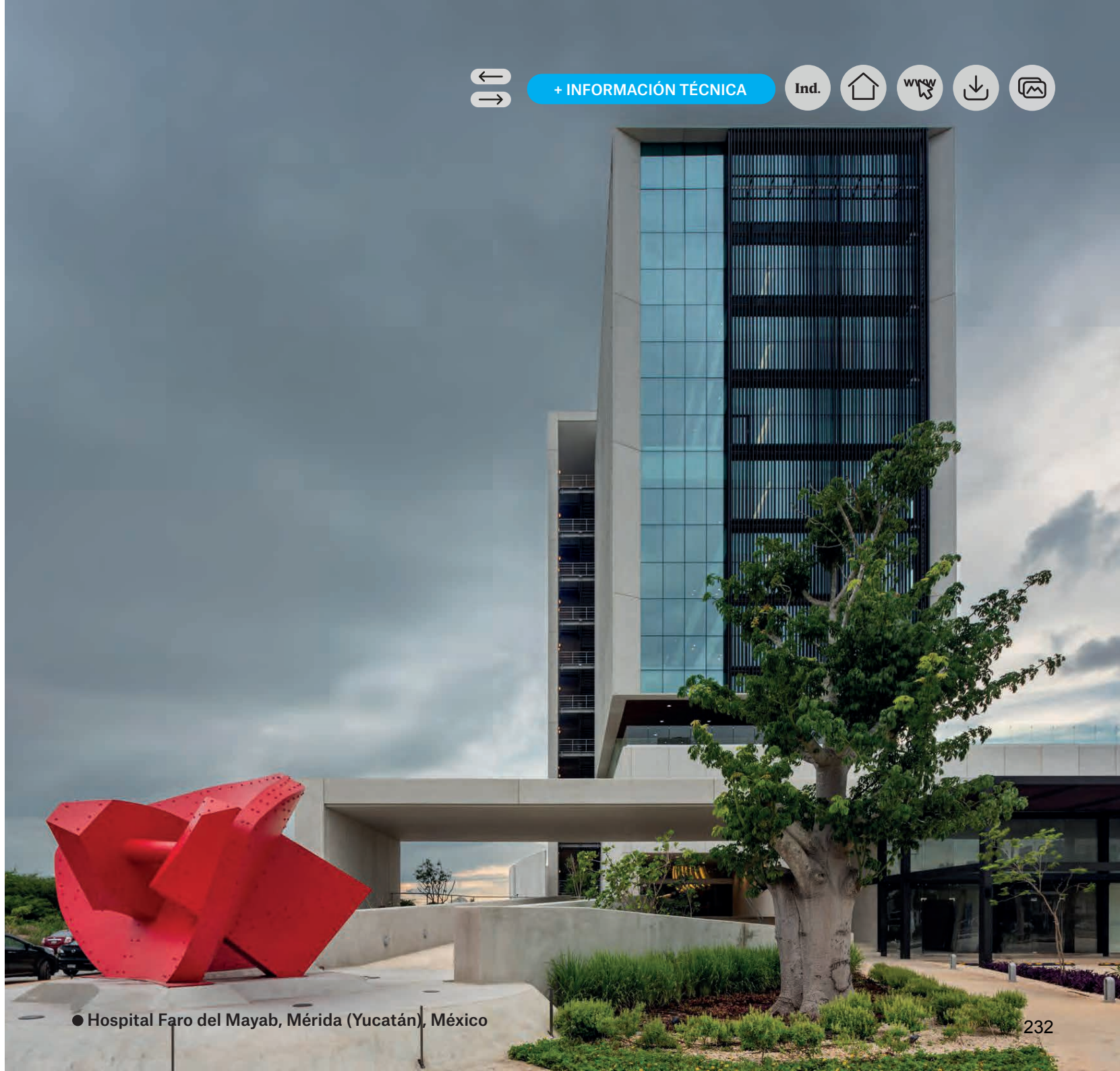



Puck

“Sistema de Iluminación integrado en barandillas”

Design by Wila

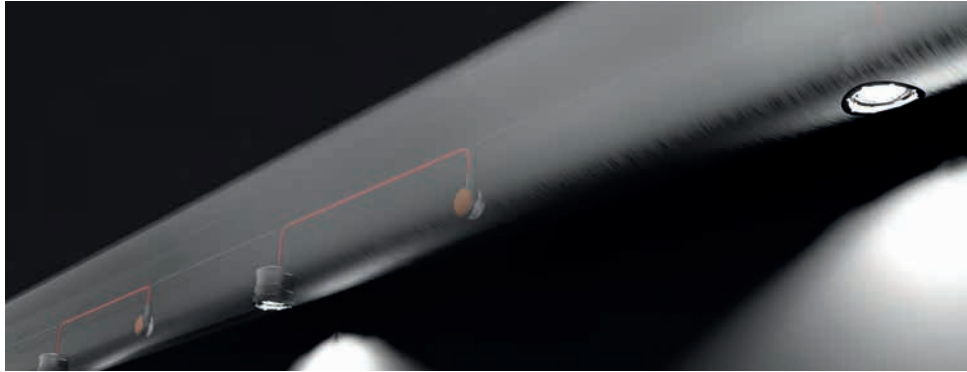

Sistema de iluminación para integración en barandillas

(Sección redonda)

Apto tanto para instalaciones interiores y exteriores



Durabilidad y robustez

Luminaria en cuerpo de acero inoxidable 316 V4A, resistente a la corrosión;
Apto para instalación en ambientes marinos;
Apto para instalación en exteriores, índice de estanqueidad IP66; Resistencia antivandálica IK10;
Vida útil de 50.000 horas (L80 B10);



+ INFORMACIÓN TÉCNICA

Ind.

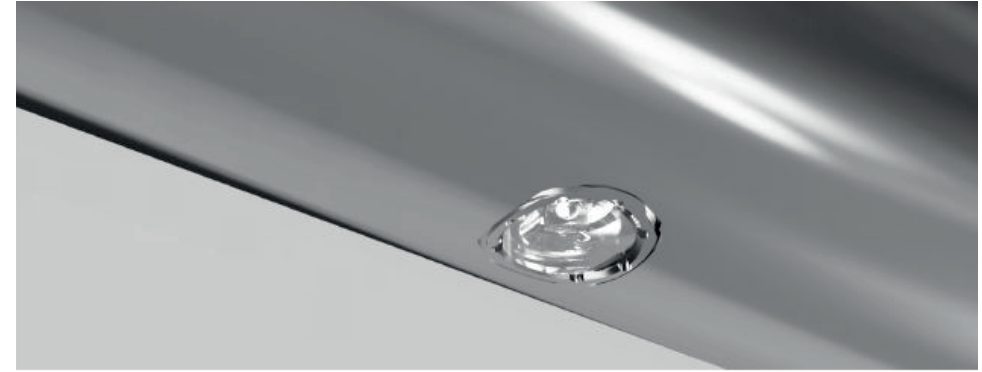

Diversidad de aplicaciones y versatilidad lumínica

Luminaria de acero inoxidable con lente de policarbonato especialmente desarrollada para aplicaciones de pasamanos, con diversas opciones de distribución fotométrica (**Simétrica; Doble simétrica; Asimétrica**)

Índice de reproducción cromática CRI > 80 y disponibilidad de temperatura de color 3000K y 4000K.

Eficiencia: hasta 123 lm/W





+ INFORMACIÓN TÉCNICA

Ind.



Wurzburg University, Germany

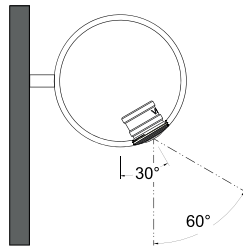

Distribución Simétrica



MP1201501

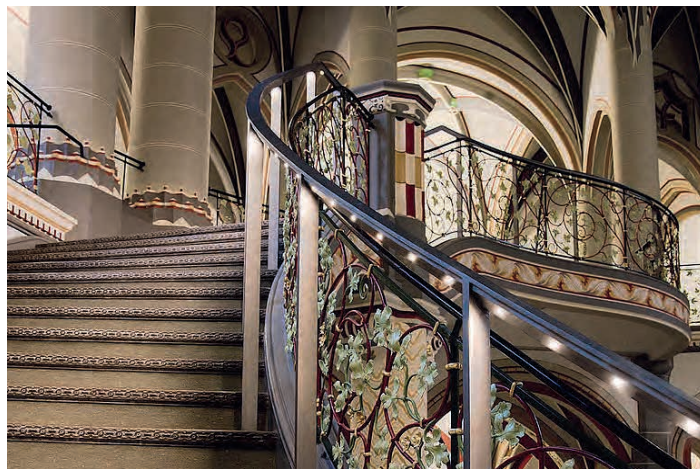
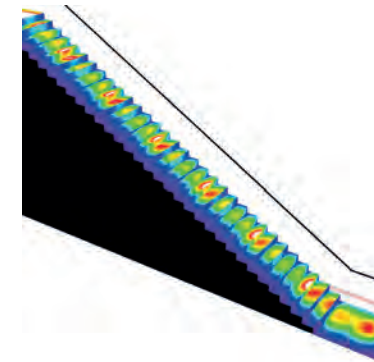

Halle District Cour, Germany

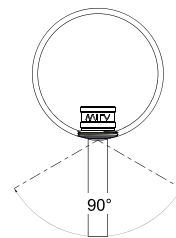

Distribución Doble Simétrica



MP1201503

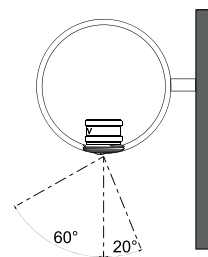
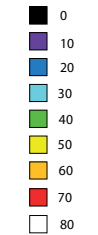
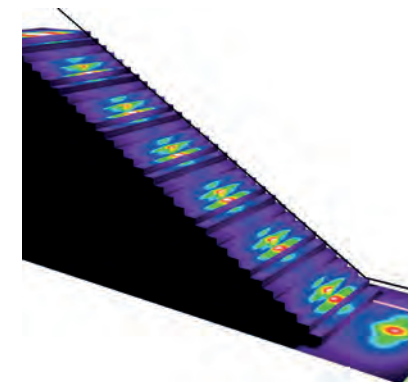

Distribución unilateral

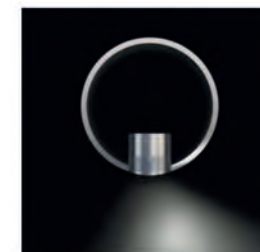

MP1201505

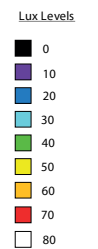
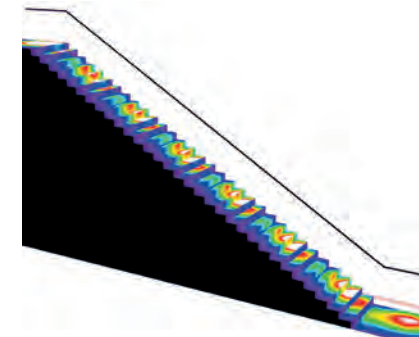

Lup

“Iluminación pensada para dar relevancia al entorno”

Bajo un mismo lenguaje formal, Lup Aplique y Downlight resuelven tanto la iluminación de acento como la general en los espacios exteriores, gracias a la optimización de su diseño que busca la mimetización con el entorno y la mayor versatilidad lumínica.

Design by Diba Studio





Versatilidad

Familia de downlights y apliques que siguen una misma línea estética y coherencia formal permitiendo cubrir distintas aplicaciones.

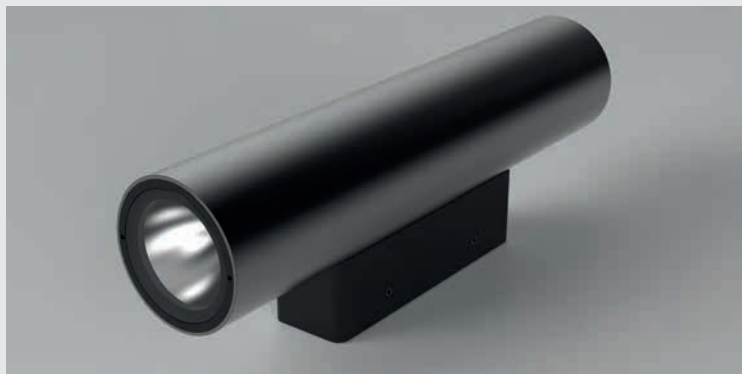

Compacto

Aplique con un diseño minimalista, elegante y compacto, en el que desaparecen las juntas, reduciendo las uniones a la mínima expresión. Este diseño permite una buena integración en los espacios.

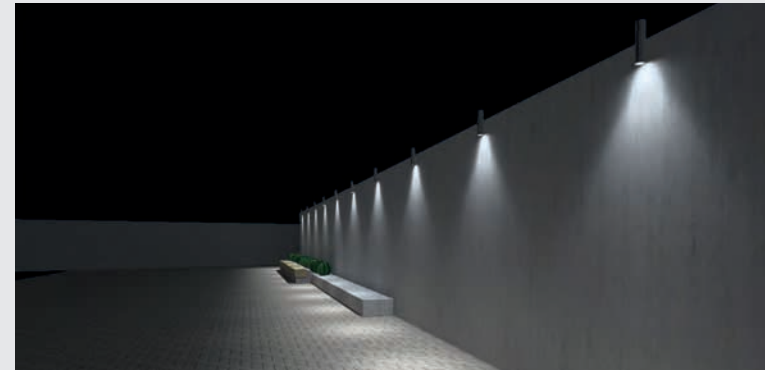

Versatilidad de efectos lumínicos - Simétrico, Asimétrico

Opción de aplique en la pared con iluminación directa e indirecta, o solo directa y también distintas ópticas; medium; spot y asimétrico.

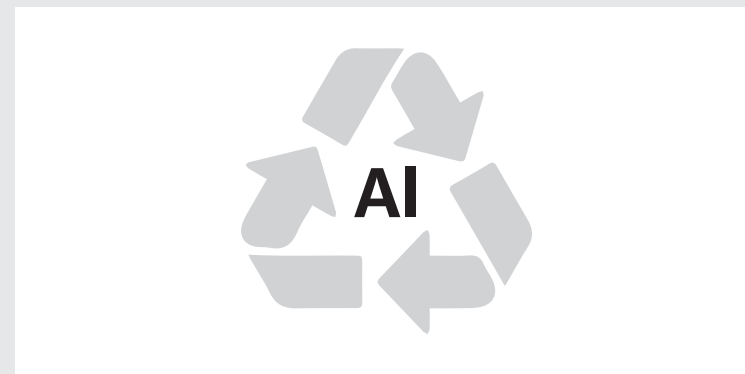

#Worktitude For Life

Fabricado en aluminio de extrusión reciclado en una tasa de 80-85%, reduciendo así la huella de carbono y el impacto ambiental.



+ INFORMACIÓN TÉCNICA

Ind.



Modelos	ø 70	ø 110	ø 110	ø 162
Dimensiones				
Lm LED	1000 lm - 3000 lm	1000 lm - 4000 lm	500 lm - 1000 lm	3000 lm - 4000 lm
IRC	80			
Ángulos apertura				
Temp. Color	3000 / 4000 K			4000 K
Equipo	ON/OFF			
Potencia	9 - 12 W	23 - 33 W	5 - 8 W	23 - 30 W
Acabados	● Negro 03			

Lup



+ INFORMACIÓN TÉCNICA

Ind.





Gap

“Iluminación que realza la arquitectura en aplicaciones altamente exigentes”

Un proyecto de diseño empírico basado en el estudio de volúmenes, en minimizar la altura de empotre y en garantizar que la estanqueidad no dependiera de su instalación, nos dio la geometría final del producto.

Design by Diba Studio & Lamp





+ INFORMACIÓN TÉCNICA

Ind.



Aplicación versátil: Uplight & Downlight

Aro especial de empotramiento para instalar en falso techo y con marco embellecedor. También permite empotrarse en suelos y paredes de poca profundidad.



Compacto: altura

Diseño muy compacto con una mínima altura de empotramiento, lo que permite instalar esta luminaria en múltiples zonas.



Óptica Orientable

Uplight empotrado orientable con opción basculante que permite ajustar la luz que emite y de fácil instalación. Esta familia permite tener óptica spot, flood, y wide flood.



Modelos



Dimensiones

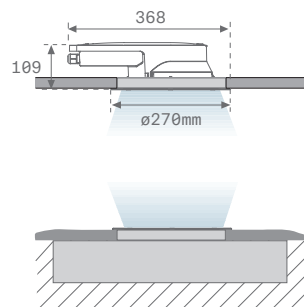

Lm LED	1400 lm - 3600 lm
IRC	80
Ángulos apertura	
Temp. Color	3000 / 4000 K
Equipo	ON/OFF
Potencia	10 - 30 W
Acabados	● Inox 02



+ INFORMACIÓN TÉCNICA

Ind.



Trace 65

“La luz revela la forma”

Buscando una forma de iluminar los espacios sin mostrar la fuente lumínica, y tomando como inspiración la huella de luz que crea la Luna durante un eclipse solar, surgió una luminaria que muestra su forma cuando se ilumina, creando una luz suave y difuminada que parece surgir del interior de una línea.

Design by Artec studio





+ INFORMACIÓN TÉCNICA

Ind.





+ INFORMACIÓN TÉCNICA

Ind.

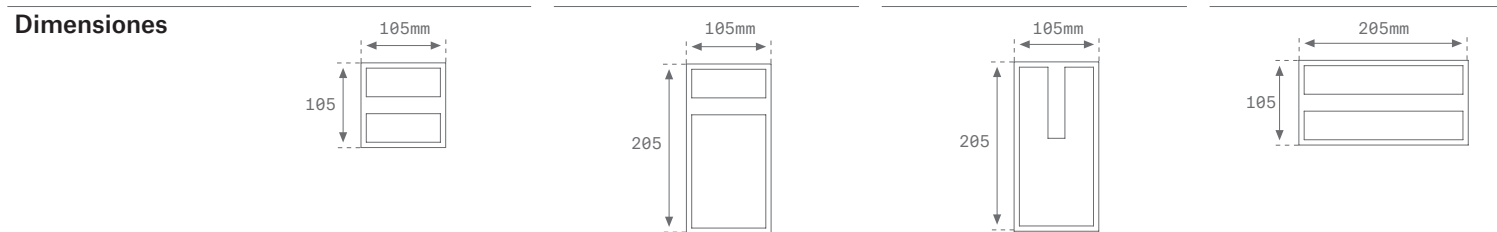

Lm LED	150 lm			300 lm
IRC	80			
Ángulos apertura	Sym.	Asym.	Asym.	Sym.
Temp. Color	3000 K			
Equipo	ON/OFF			
Potencia	1 W			3 W
Acabados	● Negro 07			



+ INFORMACIÓN TÉCNICA

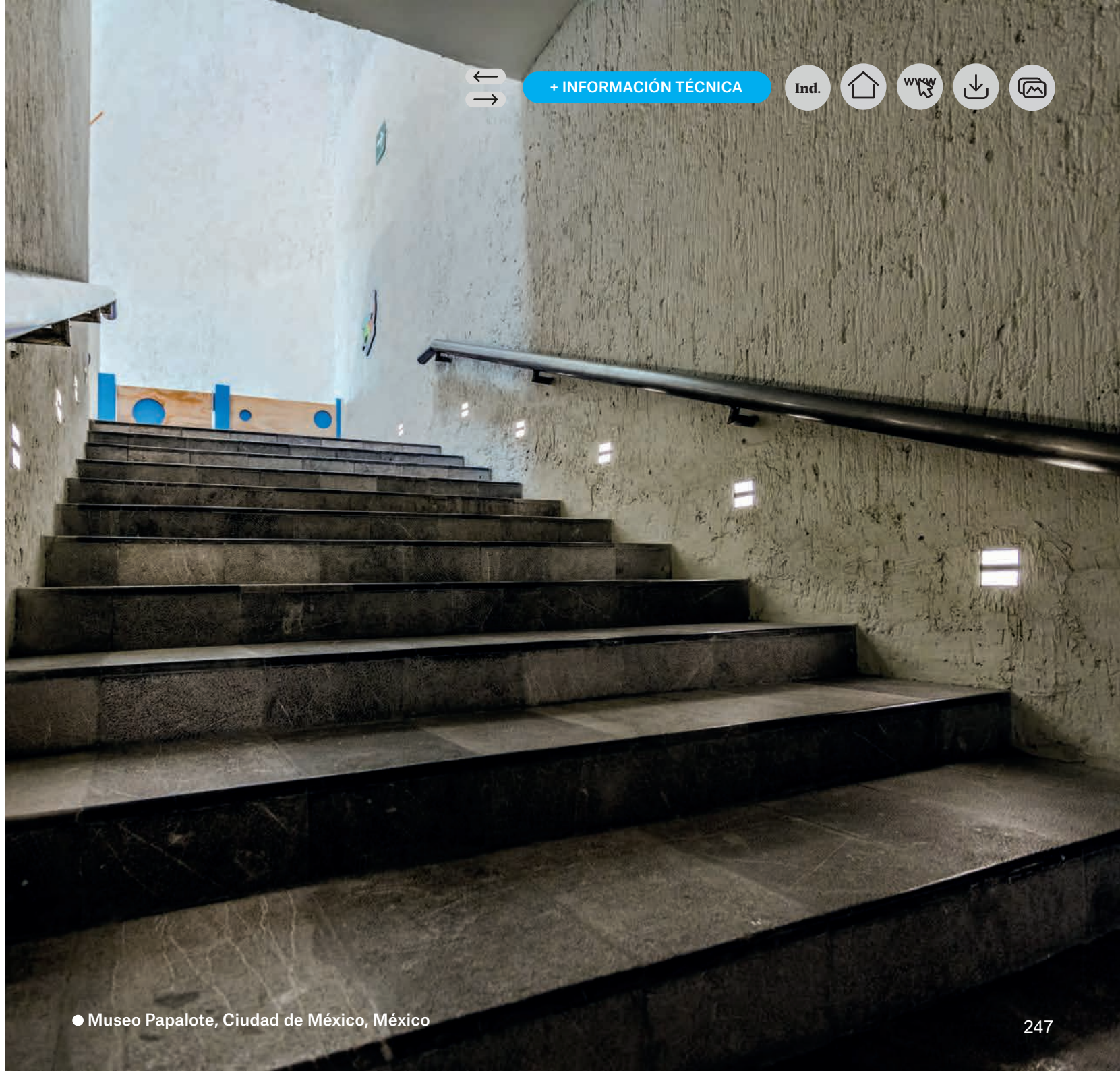



Duit

“Mayor que la suma de sus partes”

Programa de iluminación escalable en torno a una unidad lumínica que, en combinación con accesorios de instalación y ópticos, conforman un ecosistema de soluciones outdoor con un enfoque holístico y respetuoso con el medio ambiente.

Design by LA INVISIBLE LAB



Duit | Outdoor



+ INFORMACIÓN TÉCNICA

Ind.



Difusor



Antideslumbrante

Perfil principal

Clip fijador

Ópticas



Tapa Lateral

Módulo Led

Muelle fijador

Perfil Reflector

Tapa caja con junta estanqueidad

Conector

Caja conexión

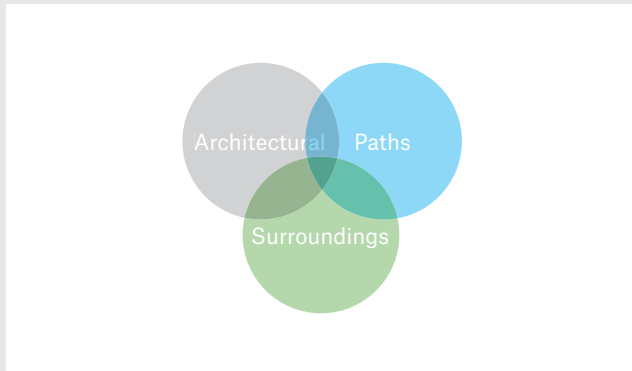

Sistema configurable de gran versatilidad:

A partir de la selección de un módulo lumínico con múltiples versiones fotométricas, y la combinación con los diversos accesorios de instalación y ópticos, DUIT se convierte en una solución lumínica capaz de abarcar la mayoría de requisitos lumínicos de un programa de iluminación arquitectónica (fachadas), iluminación de entornos para los usuarios o iluminación de recorridos.

Integración:

La optimización de las dimensiones permiten un alto grado de integración y vinculación con cualquier espacio exterior sin renunciar a los aspectos técnicos del producto. Dispone de sistemas de instalación tanto para obras nuevas como para proyectos de rehabilitación gracias a sus anclajes mínimamente intrusivos, reduciendo el impacto visual.

Sistema escalable y separable:

La conceptualización de la familia, ha sido creada para ofrecer una solución escalable y actualizable mecánica y tecnológicamente. Su construcción por partes permite una fácil separación de los materiales, los cuales pueden ser recuperados para su reciclabilidad.

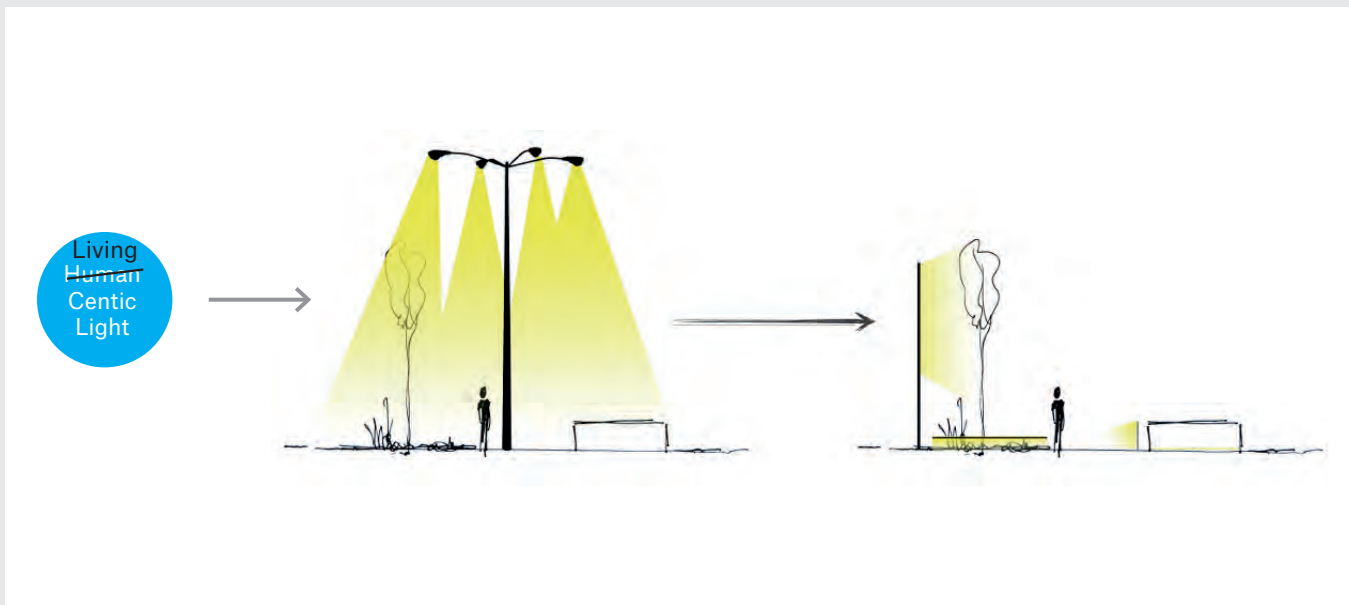

Living centric light:

DUIT permite una planificación de iluminación de cercanía, acercando la fuente de luz a la acción o al elemento que se quiere iluminar, generando atmósferas lumínicas mucho más confortables, a la vez que se reduce el consumo energético de la instalación. Cuenta con una opción en tonalidad ámbar con un espectro lumínico sumamente respetuoso con el entorno y con el ecosistema.

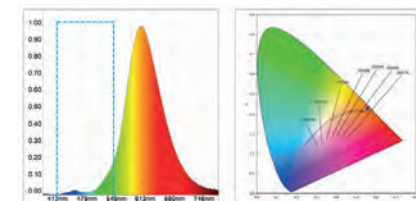



+ INFORMACIÓN TÉCNICA

Ind.



Modelos	LIGHT ENGINE	ACCESSORIES					
		BASIC		INTEGRATION		MINIMUM	
		SURFACE	INDIRECT	RECESSED	REC. ASYM	TRIMLESS	ANCHORS
Dimensiones							
Lm LED	1000 lm - 2160 lm						
IRC	80						
Ángulos apertura	WF WW GZ OP						
Temp. Color	2700 / 3000 / 4000 K / Amber						
Equipo	ON-OFF/DALI						
Potencia	1,3 - 23,4W						
Acabados	● Negro 06						



Configuración

1. Motor Lumínico



Driver



2. Accesorios de instalación

Basic

Surface

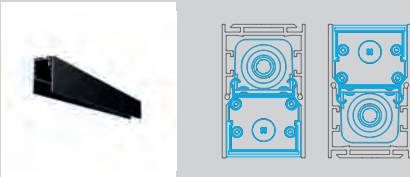

Empotrado

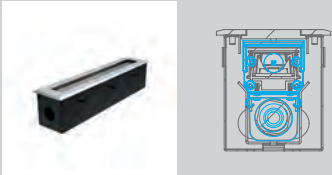

Empotrado Asimetrico

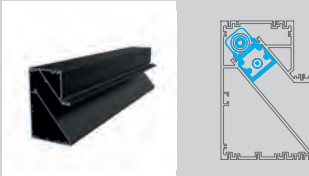

Integration

Trimless

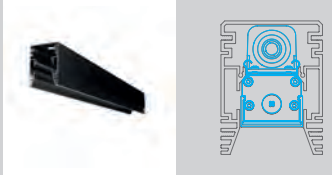

Minimum

Surface

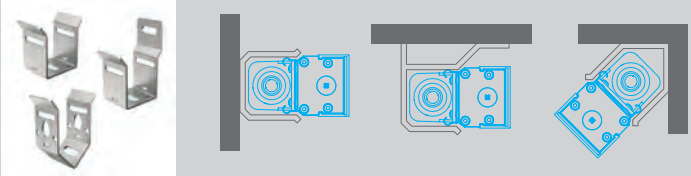

3. Accesorios Ópticos

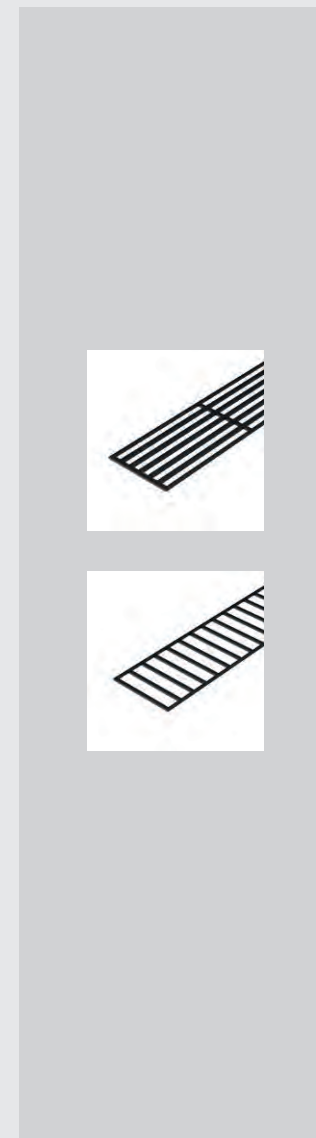



+ INFORMACIÓN TÉCNICA

Ind.



Living Centric Light

Architectural

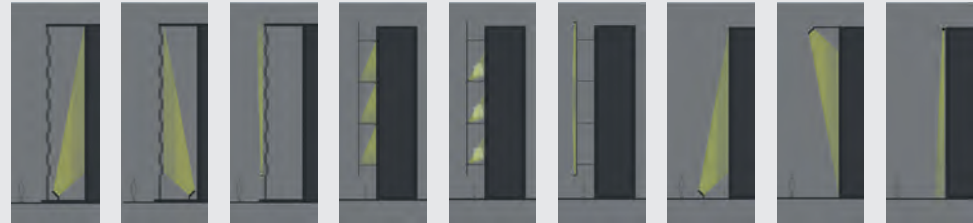

Living
Human
Centric
Light



Surroundings

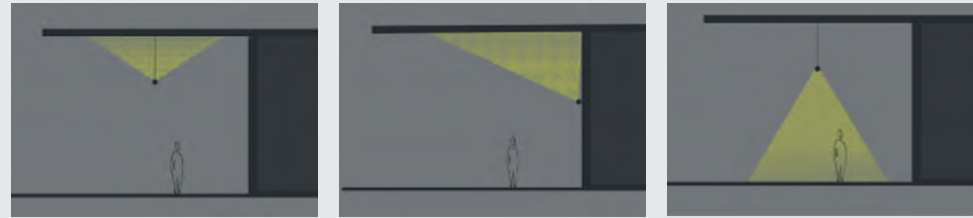
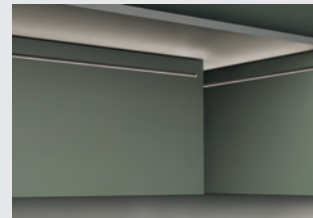

Paths

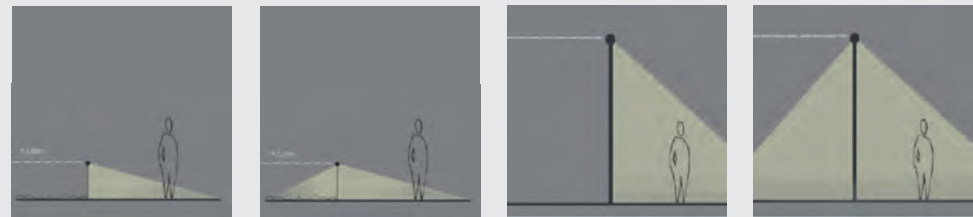
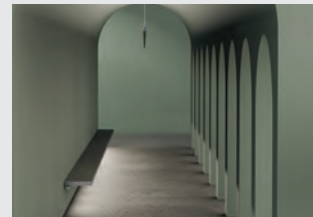



+ INFORMACIÓN TÉCNICA

Ind.



Basic Surface

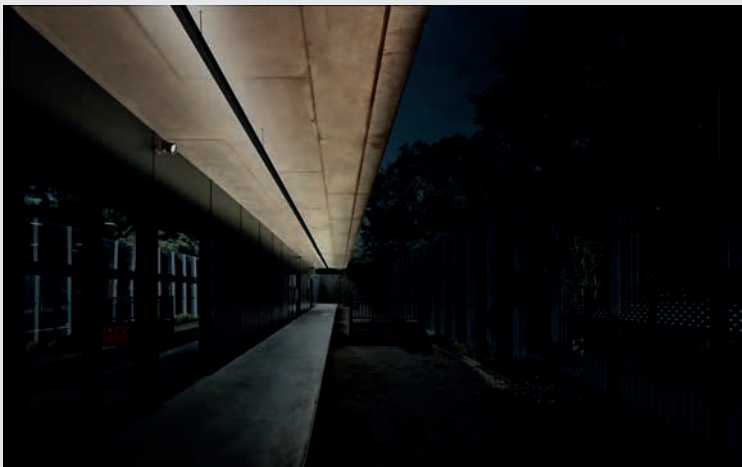
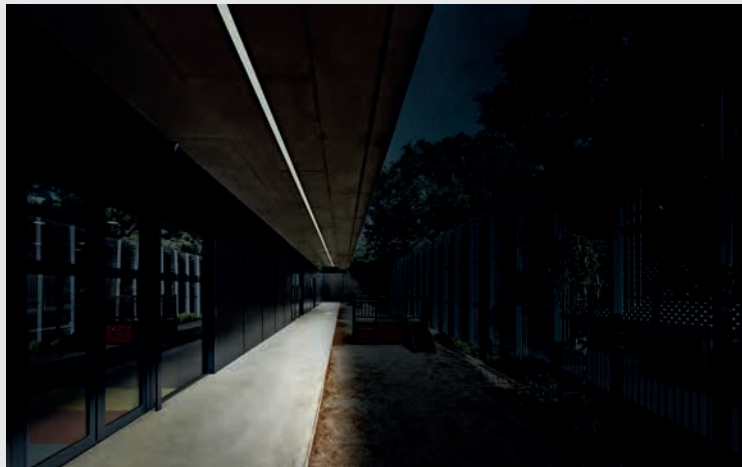
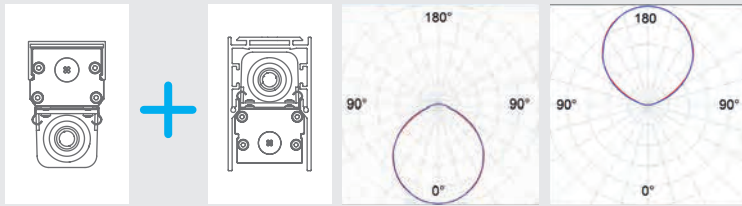

Lamp Worktitude for light

Basic Recessed

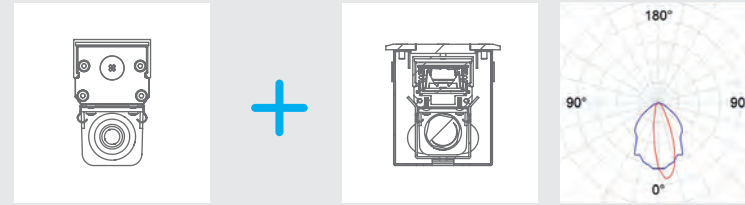



+ INFORMACIÓN TÉCNICA

Ind.



Integration Trimless

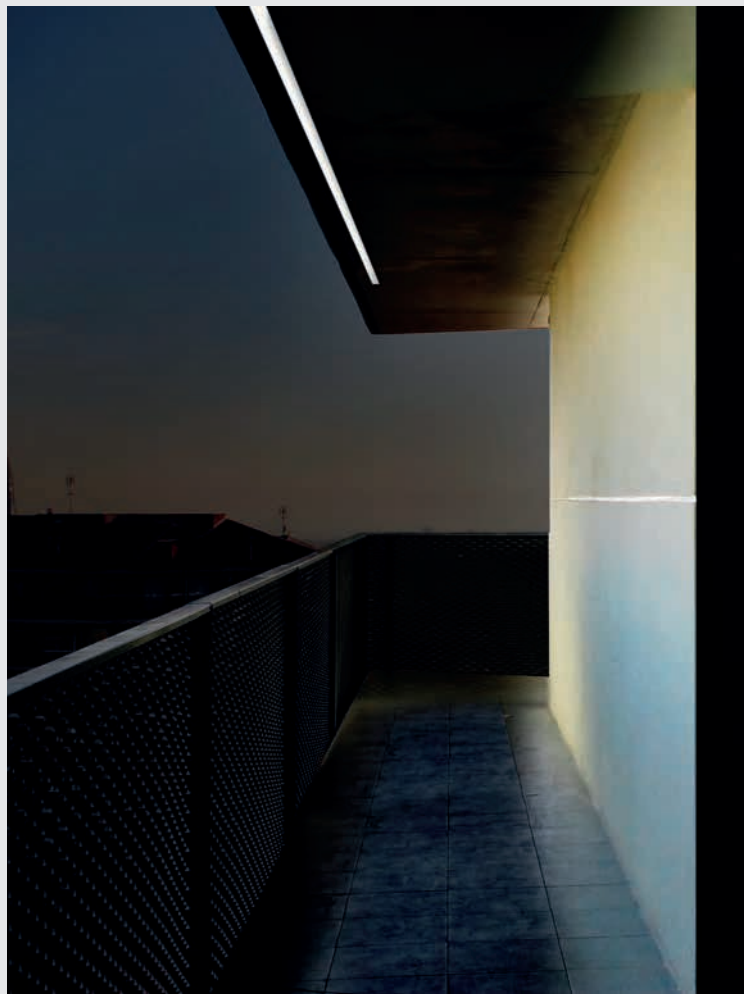
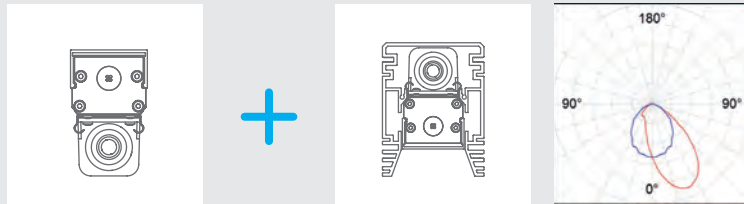

Lamp Worktitude for light

Integration Asymmetric

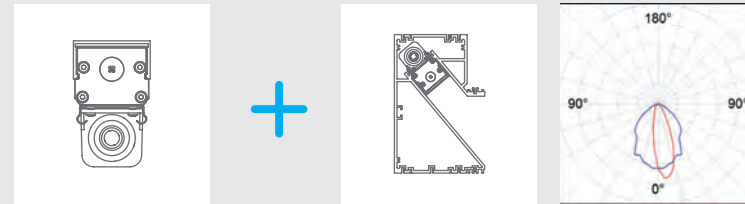

Bazz

“Uniformidad lumínica”

Bazz nace de la necesidad de proporcionar uniformidad lumínica y facilidad de instalación en aplicaciones lineales de exterior. Es un producto con un marcado carácter técnico y con gran amplitud de gama que nos aporta soluciones concretas para una gran variedad de aplicaciones de “Arquitectural”.

Design by Lamp





+ INFORMACIÓN TÉCNICA

Ind.



Versatilidad de aplicaciones

Esta familia está diseñada para dar solución a distintos métodos de instalación; tanto empotrado en suelo como en superficie orientable.

Las tapas finales están fabricadas en inyección de aluminio y permiten la inclinación de la luminaria orientando la dirección de la luz donde más convenga para cada aplicación.



Facilidad de instalación

Unos conectores rápidos y estancos colocados en las tapas finales de la luminaria permiten una fácil y cómoda instalación.



Líneas continuas

Además de las longitudes estándar, esta luminaria está diseñada para instalarse en líneas continuas y la customización de sus longitudes.

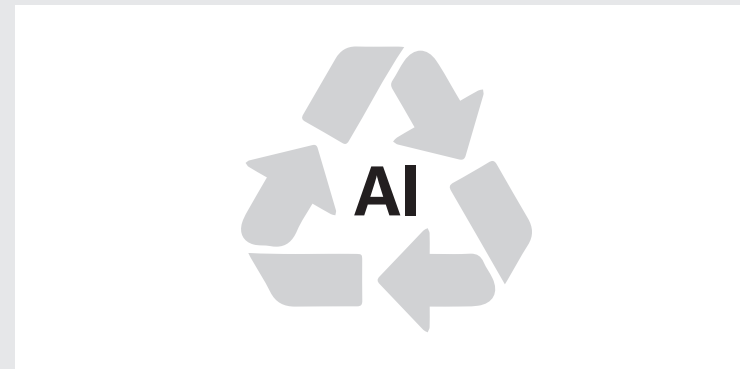

#Worktitude For Life





Fabricado en aluminio de extrusión reciclado en una tasa de 80-85%, reduciendo así la huella de carbono y el impacto ambiental.

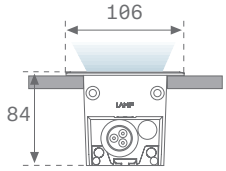
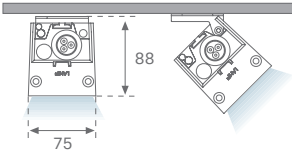

+ INFORMACIÓN TÉCNICA

Ind.



Modelos	RECESSED				AIR			
	SYM	ASY	WW	OPAL	SYM	ASY	WW	OPAL
Dimensiones								
Lm LED	1980 lm - 8100 lm				4200 lm			
IRC	80							
Ángulos apertura	 Sym.  Asym.  WW  Opal							
Temp. Color	3000 / 4000 K		3000 / 4000 K		3000 / 4000 K		3000 / 4000 K	
Equipo	ON/OFF							
Potencia	19 - 75 W		37 - 75 W		31 - 63 W		19 - 75 W	
Acabados	● Negro 06							



Bauline

“Luz rasante lineal”

Es un producto caracterizado por su pequeño tamaño y versatilidad de aplicación. Puede ser utilizado para aplicaciones de luz rasante, para enfatizar una superficie, para acentuar texturas o perimetralmente para delimitar espacios.

Design by Lamp

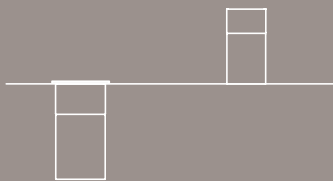



+ INFORMACIÓN TÉCNICA

Ind.





+ INFORMACIÓN TÉCNICA

Ind.



Modelos

RECESSED



SURFACE



Dimensiones

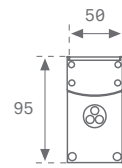
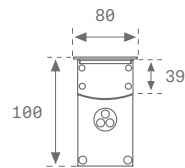

Lm LED 3600 lm - 5000 lm

IRC 80

Ángulos apertura



Temp. Color 3000 / 4000 K

Equipo ON/OFF

Potencia 17 W

34 W

Acabados ● Gris 02



+ INFORMACIÓN TÉCNICA

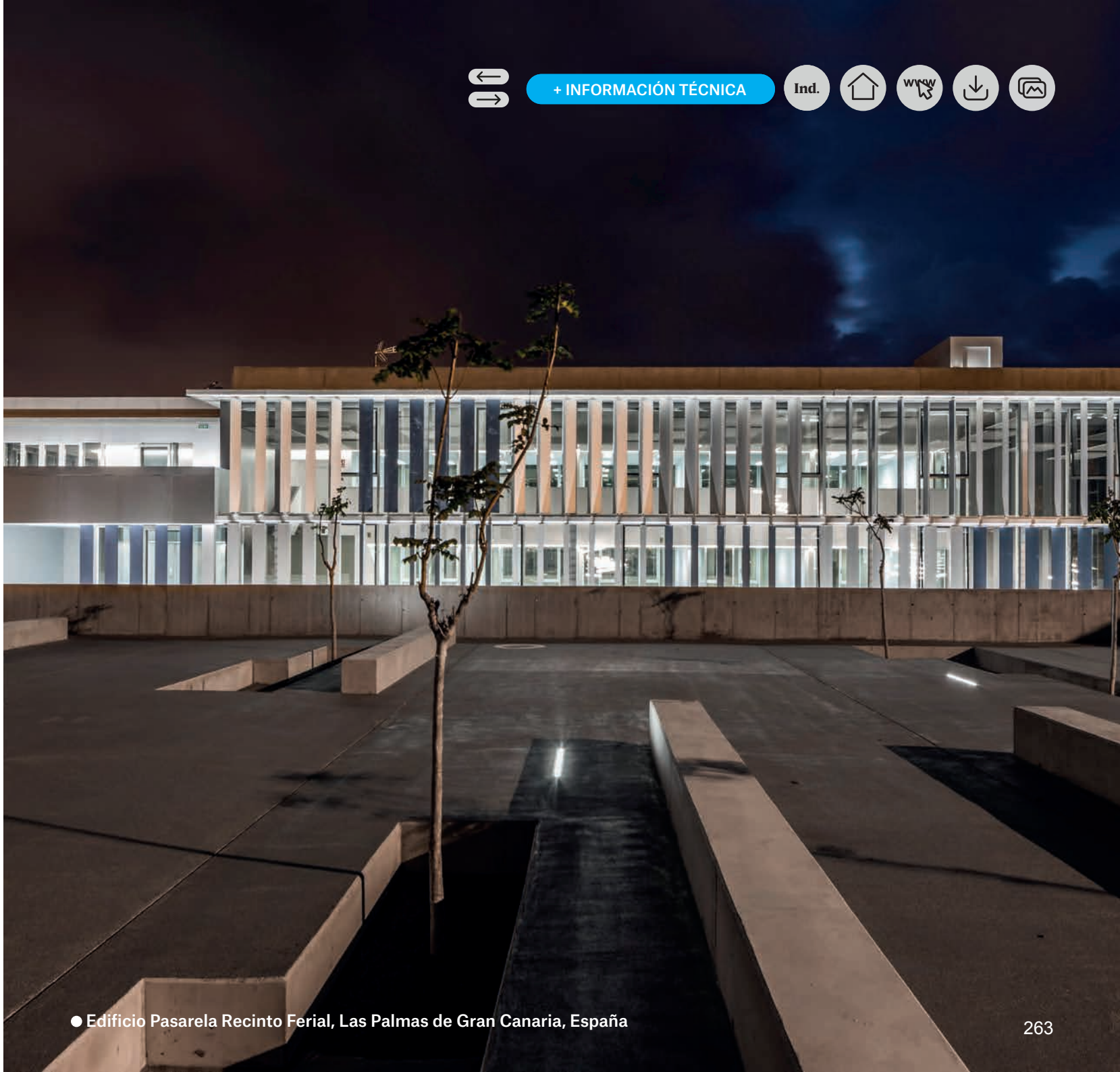

Flut

“La forma obedece a la función”

Flut es un claro ejemplo de la filosofía defendida por la escuela Bauhaus con la famosa frase: “La forma obedece a la función”. Una familia de productos con un diseño neutro y compacto, con una amplia oferta de soluciones y pensado para simplificar el proceso de instalación.

Design by Lamp

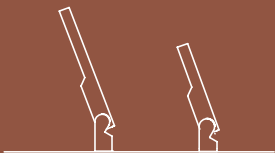



Múltiples posibilidades de orientación

Esta familia contiene una rótula que permite giros entre 90° y -30° para orientarlo hacia la dirección deseada e incorpora una válvula anticondensación.



Amplia gama de accesorios

Dispone de una amplia gama de accesorios, como aletas antideslumbrantes, así como soportes y abrazaderas para crear un Sistema Vial, con columnas troncocónicas o cilíndricas, idóneo para iluminar zonas peatonales.





Diseño compacto

El diseño compacto de esta luminaria, integra la máxima eficiencia en un espacio muy reducido, permitiendo un mínimo impacto en el entorno.

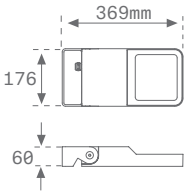
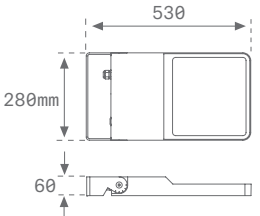

Modelos	FLUT 180	FLUT 280
		

Dimensiones	FLUT 180	FLUT 280
		

Lm LED	3000 lm - 5000 lm	9300 lm - 18700 lm
IRC	80	80
Ángulos apertura		
Temp. Color	3000 / 4000 K	
Equipo	ON/OFF	
Potencia	23 - 44 W	54 - 117 W
Acabados	● Gris 03	● Antracita 01

Flut



+ INFORMACIÓN TÉCNICA





+ INFORMACIÓN TÉCNICA

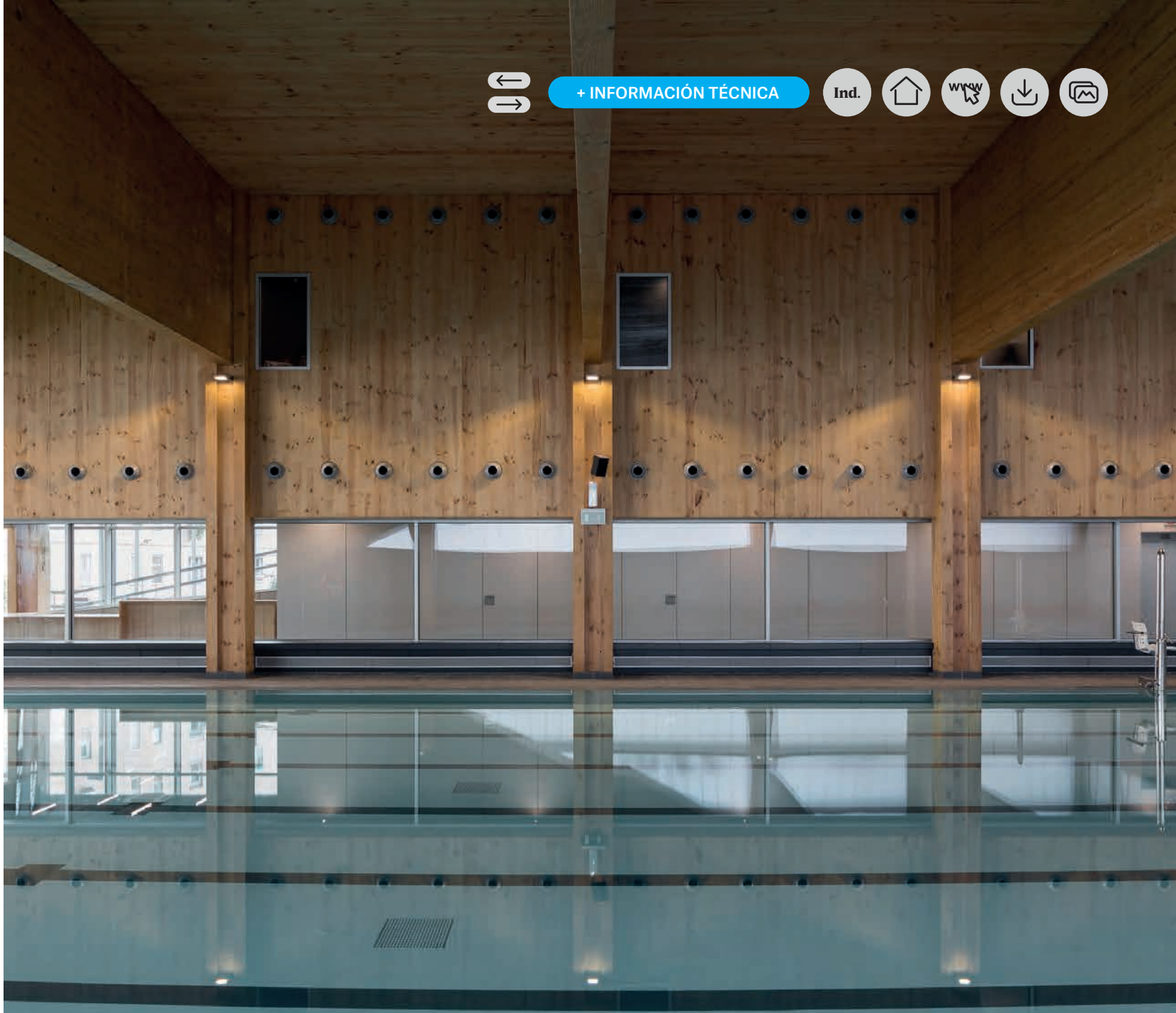

Shot

“Pureza técnica”

A partir de unas premisas técnicas basadas en el rendimiento y el mantenimiento de la luminaria, se diseñó una geometría que respondía a motivos estrictamente funcionales, como la disipación de temperatura, sin añadir elementos superfluos.

Design by Diba Studio & Lamp





+ INFORMACIÓN TÉCNICA

Ind.



Eficiencia mejorada en un 50%

La tercera generación de Shot 290 y Shot 380 pasa de un promedio de 89,6lm/W a 136 lm/W, lo que supone un 50% de mejora en eficiencia.



+ INFORMACIÓN TÉCNICA

Ind.



Modelos	SHOT 80	SHOT 120	SHOT 180	SHOT 290	SHOT 380
Dimensiones					
Lm LED	900 lm	1500 lm - 3800 lm	5000 lm - 7000 lm	6500 lm	7000 lm - 10500 lm
IRC	80				
Ángulos apertura					
Temp. Color	3000 / 4000 K	2700 / 3000 / 4000 K			
Equipo	ON/OFF - TRIAC				
Potencia	6 W	10 - 30 W	37 - 56 W	48 W	45 - 73 W
Acabados	● Gris 03	● Antracita 01			

Shot

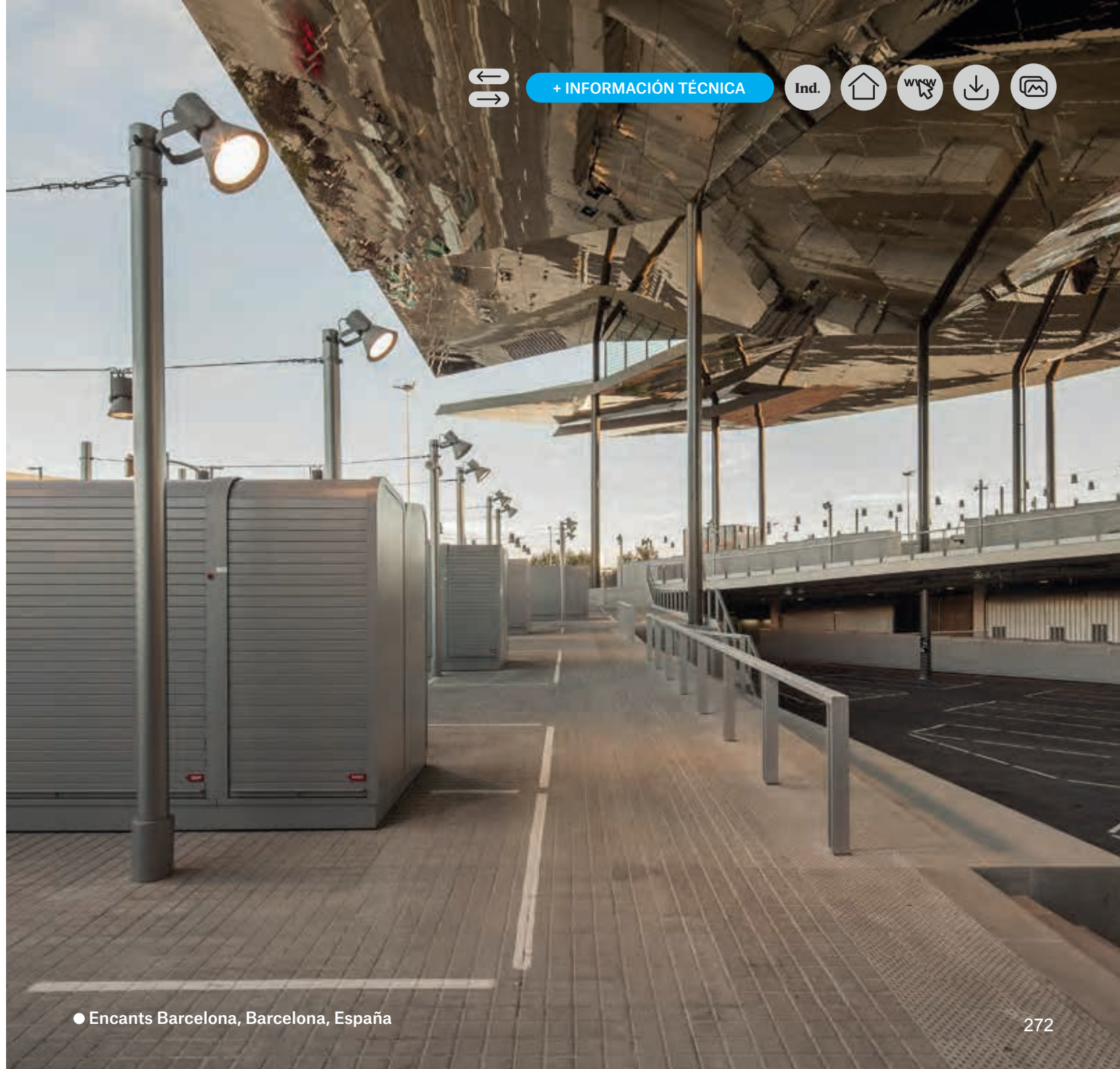

+ INFORMACIÓN TÉCNICA





+ INFORMACIÓN TÉCNICA

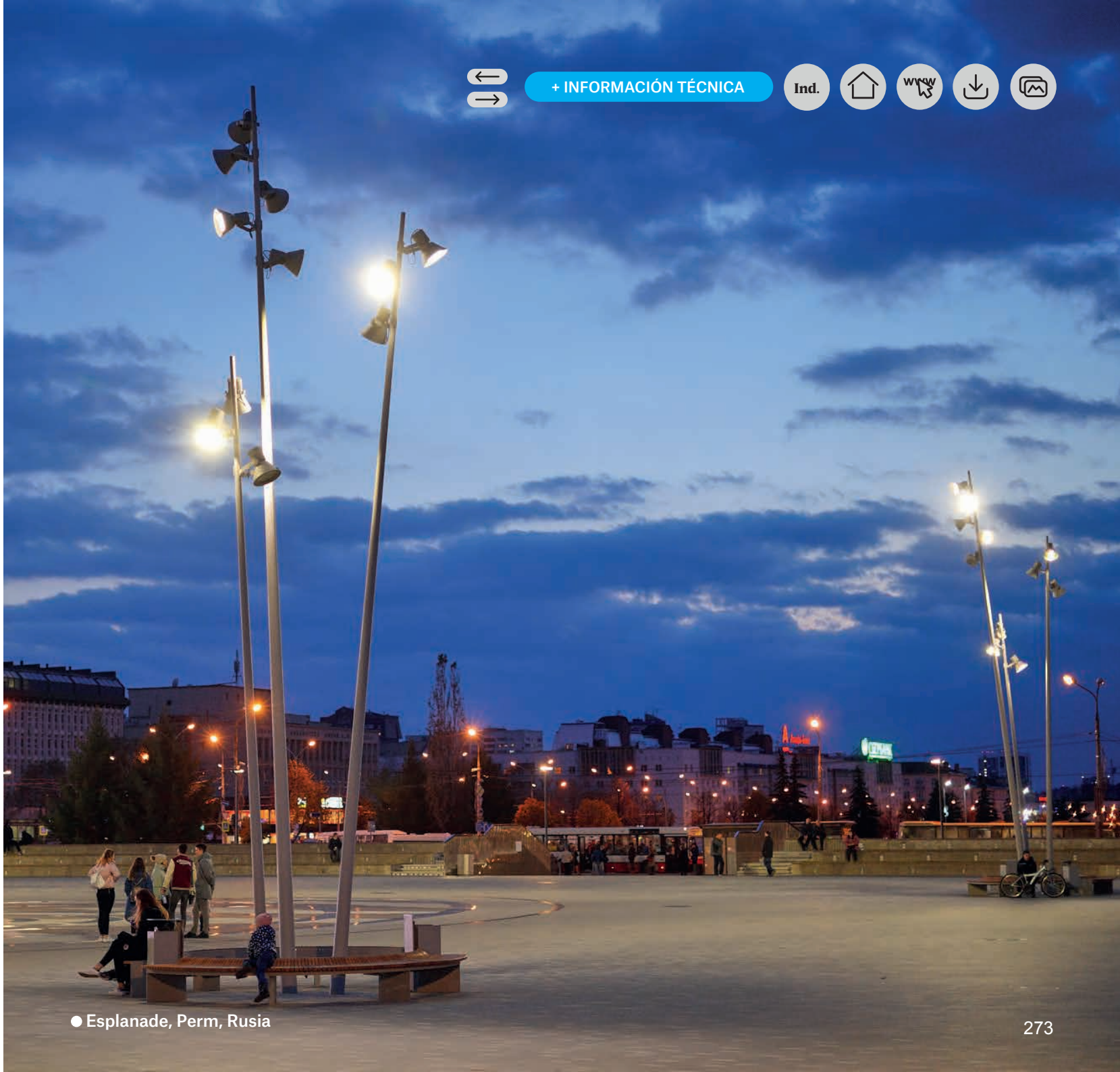



INDOOR

A

- AMBIENT

D

- DOMO 220

F

- FIL 35
- FIL 45
- FIL 50
- FIL 70
- FIL 120
- FINE LED STRIP

G

- GENERAL ACC.

H

- HANCE 48V
- HANCE DOWN.
- HANCE SPOT.
- HEALTH & WELL
- HERMETICA

I

- IMAG

K

- KOMBIC DOWN.
- KOMBIC SUR.

L

- LAMPTUB 60
- LAMPTUB 80

M

- MODULAR CUSTOM
- MOODY
- MUN DARK
- MUN LIGHT

O

- OCULT DOWN.
- OCULT SYSTEM

P

- PLAT
- PUZZLE

Q

- QUIET

R

- RING

S

- STORMBELL
- STORMBELL 80

T

- TRACK
- TRANSIT

OUTDOOR

B

- B-SIDE
- BAULINE
- BAZZ

D

- DUIT

F

- FLUT

G

- GAP
- GENERAL ACC.

L

- LUP

M

- MUN DARK IP65

N

- NIU

O

- OWL

P

- PUCK

S

- SETI
- SHOT

T

- TRACE IP65

U

- URBAN 100

X

- XTREMA



Ambient

Ambient

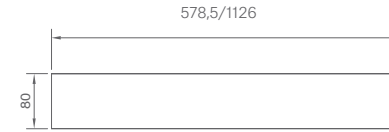
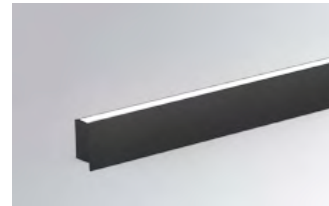
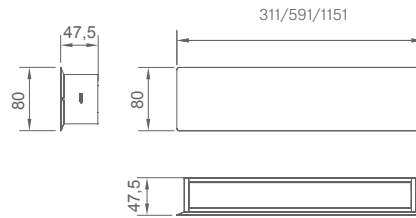
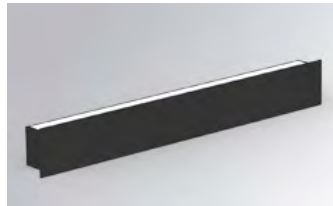

*Imagen de luminaria individual + accesorio frontal

*Imagen de luminaria continúa + accesorio frontal

AMBIENT APLIQUE LINEAL (INDIVIDUAL) Familia

Formato	Instalación	Lm LED/m	Óptica	IRC	K	Equipo	Acabados Acc.	
AM2	030 300mm 060 600mm 120 1200mm	DR Individual directo	OP Opal	8 80	30 3000K 40 4000K	N ON/OFF D DALI	B Black 02 W White 02	
			AS Asym				TW Tunable White	B Black 02 W White 02
			GZ Grazer					B Black 02 W White 02
	030 300mm 060 600mm 120 1200mm	DI Individual dir / ind	OO Opal-Opal	8 80	30 3000K 40 4000K	N ON/OFF D DALI	B Black 02 W White 02	
			OA Opal-Asym				TW Tunable White	B Black 02 W White 02
			OO Opal-Opal					B Black 02 W White 02
	120 1200mm	DS Ind dir/ind doble encendido	OO Opal-Opal	8 80	30 3000K 40 4000K	N ON/OFF D DALI	B Black 02 W White 02	
	060 600mm		OA Opal-Asym				TW Tunable White	B Black 02 W White 02
			OG Opal-Grazer					B Black 02 W White 02
	120 1200mm	AS Asym-Grazer	OO Opal-Opal	8 80	30 3000K 40 4000K	N ON/OFF D DALI	B Black 02 W White 02	
							AG Asym-Grazer	B Black 02 W White 02
	AM2	060	DI	MO	OA	8	30	D

AMBIENT SISTEMA LINEAL (CONTÍNUO)

Familia	Formato	Instalación	Lm LED/m	Óptica	IRC	K	Equipo	Acabados Acc.	
AM2	060 600mm 120 1200mm	DR Direct	MO 2500lm/m	OP Opal	8 80	30 3000K 40 4000K	N ON/OFF D DALI	B Black 02 W White 02	
				AS Asym				OO Opal-Opal	B Black 02 W White 02
				GZ Grazer					B Black 02 W White 02
060 600mm 120 1200mm	DI Dir / Ind	MO 2500lm/m	OO Opal-Opal	8 80	30 3000K 40 4000K	N ON/OFF D DALI	B Black 02 W White 02		
			OA Opal-Asym				TW Tunable White	B Black 02 W White 02	
			OO Opal-Opal					B Black 02 W White 02	
AM2	060	DI	MO	OA	8	30	D	B	



*ACCESORIO FRONTAL NO INCLUIDO.

Pág. 279



CARACTERÍSTICAS TÉCNICAS

Ópticas

OP

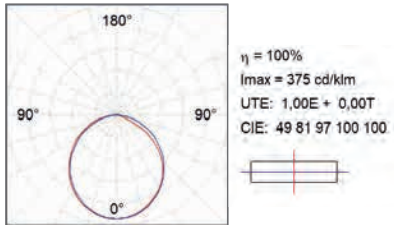

OO

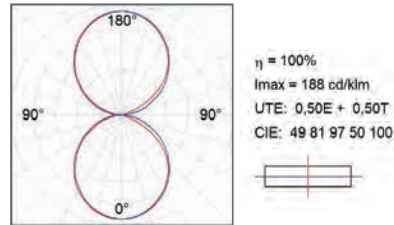

AS

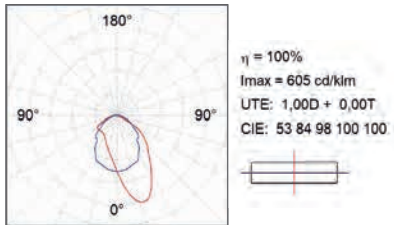

OA

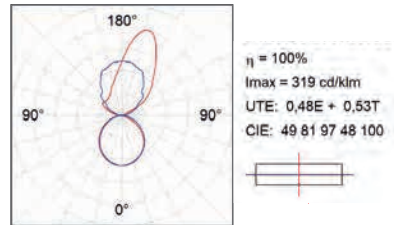

GZ

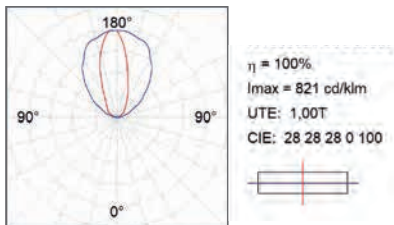

OG

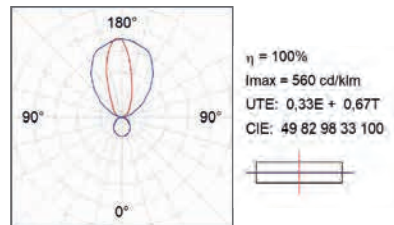

AG

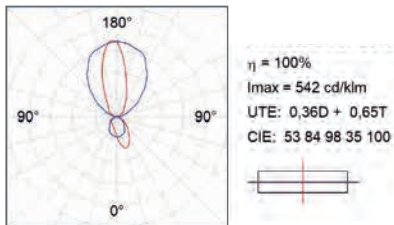

CARACTERÍSTICAS TÉCNICAS

Flujo de salida y potencia



AMBIENT APLIQUE LINEAL DIRECTO

	K	CRI	300mm		600mm		1200mm	
			W	lm Output	W	lm Output	W	lm Output
OP	3000	80	5,4	495	9,8	990	18,6	1980
	4000	80	5,4	519	9,8	1039	18,6	2077
	TW	80			8,7	991	16,3	1982
AS	3000	80	5,4	544	9,8	1088	18,6	2176
	4000	80	5,4	571	9,8	1141	18,6	2283
GZ	3000	80	8,3	995	15,8	1990	30,5	3980
	4000	80	8,3	1055	15,8	2109	30,5	4219

AMBIENT SISTEMA LINEAL DIRECTO

	K	CRI	600mm		1200mm	
			W	lm Output	W	lm Output
OP	3000	80	9,8	990	18,6	1980
	4000	80	9,8	1039	18,6	2077
	TW	80	8,7	991	16,3	1982
AS	3000	80	9,8	1088	18,6	2176
	4000	80	9,8	1414	18,6	2283
GZ	3000	80	15,4	1990	30,5	3980
	4000	80	15,4	2109	30,5	4219

AMBIENT APLIQUE LINEAL DIRECTO/INDIRECTO

	K	CRI	300mm		600mm		1200mm	
			W	lm Output	W	lm Output	W	lm Output
OP/OP	3000	80	9,8	990	18,6	2078	34,5	3960
	4000	80	9,8	1039	18,6	2180	34,5	4154
	TW	80			16,3	1982	31,9	3964
OP/AS	3000	80	9,8	1088	18,6	2078	34,5	4156
	4000	80	9,8	1414	18,6	2180	34,5	4360
AS/GZ	3000	80					49,1	6156
	4000	80					49,1	6458
OP/GZ	3000	80					49,1	6156
	4000	80					49,1	6458

AMBIENT SISTEMA LINEAL DIRECTO/INDIRECTO

	K	CRI	600mm		1200mm	
			W	lm Output	W	lm Output
OP/OP	3000	80	18,6	2078	34,8	3960
	4000	80	18,6	2077	34,8	4154
	TW	80	16,3	1982	31,9	3964
OP/AS	3000	80	18,6	2078	34,8	4156
	4000	80	18,6	2180	34,8	4360
AS/GZ	3000	80			49,1	6156
	4000	80			49,1	6458
OP/GZ	3000	80			49,1	5960
	4000	80			49,1	6253





ACCESORIOS

Accesorio frontal para aplique lineal (INDIVIDUAL)

Ref.	mm	Color
AM2ACIN030B	300	● Black
AM2ACIN030W	300	○ White
AM2ACIN060B	600	● Black
AM2ACIN060W	600	○ White
AM2ACIN120B	1200	● Black
AM2ACIN120W	1200	○ White
AM2ACIN030ABK	300	● Anodised Black
AM2ACIN030ABL	300	● Anodised Blue
AM2ACIN030ABZ	300	● Anodised Bronze
AM2ACIN030ACH	300	● Anodised Champagne
AM2ACIN030AGD	300	● Anodised Gold
AM2ACIN030ARW	300	● Anosided Raw
AM2ACIN060ABK	600	● Anodised Black
AM2ACIN060ABL	600	● Anodised Blue
AM2ACIN060ABZ	600	● Anodised Bronze
AM2ACIN060ACH	600	● Anodised Champagne
AM2ACIN060AGD	600	● Anodised Gold
AM2ACIN060ARW	600	● Anosided Raw
AM2ACIN120ABK	1200	● Anodised Black
AM2ACIN120ABL	1200	● Anodised Blue
AM2ACIN120ABZ	1200	● Anodised Bronze
AM2ACIN120ACH	1200	● Anodised Champagne
AM2ACIN120AGD	1200	● Anodised Gold
AM2ACIN120ARW	1200	● Anosided Raw

Accesorio frontal intermedio para SISTEMA LINEAL (CONTÍNUO)

Ref.	mm	Color
AM2AC120B	1200	● Black
AM2AC120W	1200	○ White
AM2AC120ABK	1200	● Anodised Black
AM2AC120ABL	1200	● Anodised Blue
AM2AC120ABZ	1200	● Anodised Bronze
AM2AC120ACH	1200	● Anodised Champagne
AM2AC120AGD	1200	● Anodised Gold
AM2AC120ARW	1200	● Anosided Raw

Accesorio frontal END

Ref.	mm	Color
AM2AC060B	600	● Black
AM2AC060W	600	○ White
AM2AC060ABK	600	● Anodised Black
AM2AC060ABL	600	● Anodised Blue
AM2AC060ABZ	600	● Anodised Bronze
AM2AC060ACH	600	● Anodised Champagne
AM2AC060AGD	600	● Anodised Gold
AM2AC060ARW	600	● Anosided Raw

Tapa final (para SISTEMA LINEAL (CONTÍNUO))

Ref.	Color
AM2ACECB	○
AM2ACECW	●



***ACCESORIO FRONTAL NO INCLUIDO.**

Acabados anodizados: solo disponible para accesorio frontal (luminaria blanca o negra).



Domo 220



Domo 220 Symmetric

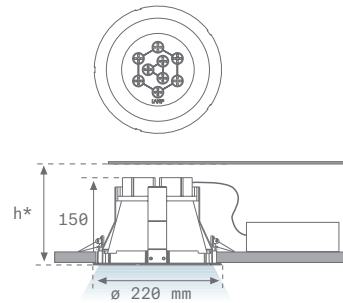

* Consultar altura (h) en hoja instrucciones

Domo 220 Asymmetric

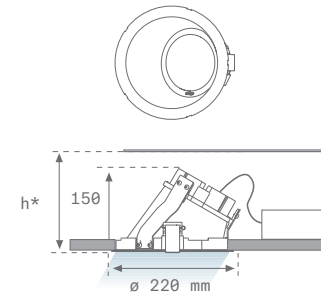

* Consultar altura (h) en hoja instrucciones

DOMO 220

Familia	Formato	Lm LED	Óptica	IRC	K	Equipo	Acabados
D02	RD Round	20 2000lm	SY Symmetric	8 80	30 3000 K	N ON/OFF	W White 02
		30 3000lm			40 4000 K	D DALI	
		40 4000lm	AS Asymmetric	8 80	30 3000 K		
D02	RD	20	SY	8	30	N	W

SY

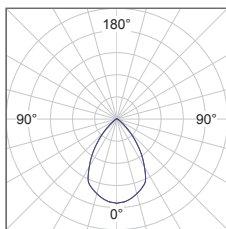

$\eta = 100\%$
 $I_{max} = 760 \text{ cd/klm}$
 UTE: 1,00B + 0,00T
 CIE: 81 97 99 100 100



AS

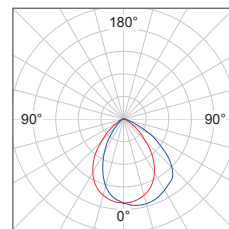

$\eta = 100\%$
 $I_{max} = 582 \text{ cd/klm}$
 UTE: 1,00C + 0,00T
 CIE: 65 93 99 100 100



DOMO 220

	K	CRI	2000lm		3000lm		4000lm	
			W	lm Output	W	lm Output	W	lm Output
SY	3000	80	23	2054	32	2825	40,9	3665
	4000	80	23	2136	32	2938	40,9	3812
AS	3000	80	23	1534	32	2110	40,9	2737





ACCESORIOS

Difusor transparente



Ref.

DITRRD240W
DITRRD240B
DITRRD240G

Color



Pict.



Difusor opal



Ref.

DIOPRD240W
DIOPRD240G

Color



Pict.



Aro embellecedor



Ref.

RIRD240W
RIRD240B
RIRD240G

Color





Fil 35



Modelos

OPAL



OPAL COMFORT



TECH



DIRECT / INDIRECT



Dimensiones

SURFACE

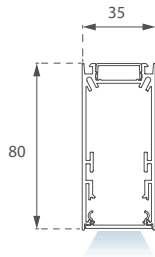

RECESSED

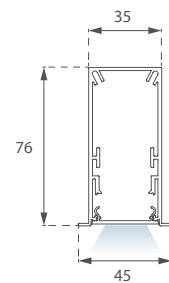

TRIMLESS

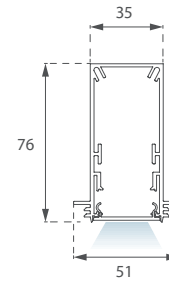

DIRECT / INDIRECT

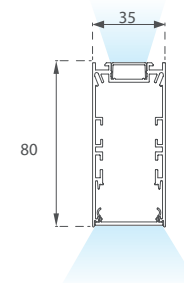

Lm LED

1200 lm

1470 lm

1600 lm

2000 lm

2400 lm

2650 lm

2800 lm

3200 lm

Longitudes

840 mm

1120 mm

1400 mm

1680 mm

1960 mm

2240mm

IRC

80 / 90

Ángulos apertura



Opal



Opal
Comfort



Tech



Dir / Ind

Temp. Color

3000 / 4000 K

Equipo

ON/OFF - DALI

Potencia

8 W

11 W

12 W

14 W

16 W

18 W

19 W

22 W

32 W

Acabados Acc.

● Negro 02

○ Blanco 02

● Gris 01



Fil 35
Opal



Fil 35
Opal Comfort



Fil 35
Tech

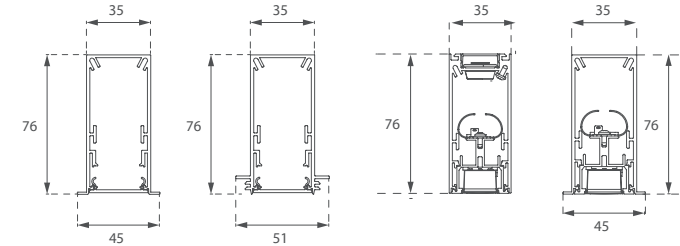

FIL 35

Familia	Instalación	Formato	Lm LED/m	Óptica	IRC	K	Equipo	Acabados					
F31	SF Surface	084 840mm	LO 1470lm	OP Opal	8 80	30 3000 K	N ON/OFF	B Black 02					
		RE Recessed							112 1120mm	MO 2650lm	40 4000 K	D DALI	W White 02
		140 1400mm											
		168 1680mm											
		196 1960mm											
		224 2240mm											
	084 840mm	LO 1470lm	OC Opal Comfort										
	112 1120mm	MO 2650lm											
	140 1400mm												
	168 1680mm												
	084 840mm	MO 2620lm		TE Tech	9 90	30 3000 K	N ON/OFF	B Black 02					
	112 1120mm								40 4000 K	D DALI	W White 02		
168 1680mm													
TR Trimless	084 840mm	LO 1470lm	OP Opal	8 80	30 3000 K	N ON/OFF	W White 02						
112 1120mm	MO 2650lm												
140 1400mm													
168 1680mm													
196 1960mm													
224 2240mm													
084 840mm	LO 1470lm	OC Opal Comfort											
112 1120mm			MO 2650lm										
140 1400mm													
168 1680mm													

F31 SF 084 LO OP 8 30 N B





CARACTERÍSTICAS TÉCNICAS

Ópticas

OP

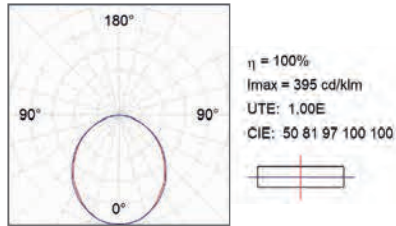

OC

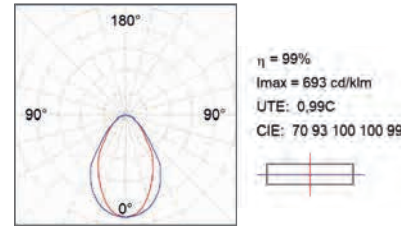

TE

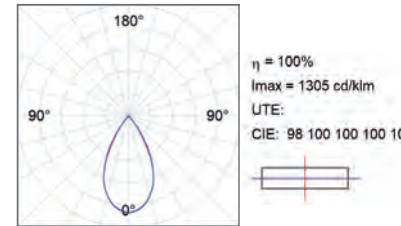

Flujo de salida y potencia

FIL 35

				1760mm		2435mm		3045mm		3674mm		4120mm		4450mm	
		K	CRI	W	lm Output	W	lm Output	W	lm Output	W	lm Output	W	lm Output	W	lm Output
LO	OP	3000	80	8,8	866	12,1	1155	14,4	1444	17,1	1733	18,9	2022	21,7	2310
		4000	80	8,8	912	12,1	1216	14	1520	17,1	1824	18,9	2128	21	2432
	OC	3000	80	8,8	801	12,1	1068	14,4	1334	17,1	1601	18,9	1868	21,7	2135
		4000	80	8,8	834	12,1	1112	14	1390	17,1	1668	18,9	1946	22	2224
MO	OP	3000	80	13,5	1281	18	1708	21,2	2135	25,2	2562	28	2989	36	3416
		4000	80	13,5	1329	18	1772	21,2	2215	25,2	2658	28	3101	36	3544
	OC	3000	80	13,5	1179	18	1571	21,2	1964	25,2	2357	-	-	-	-
		4000	80	13,5	1223	18	1630	21,2	2038	25,2	2445	-	-	-	-
	TE	3000	90	13,7	1260	17,8	1680	-	-	22	2520	-	-	-	-
		4000	90	13,7	1320	17,8	1760	-	-	22	2640	-	-	-	-



Fil 35
Direct/Indirect

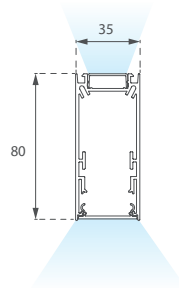

FIL 35 DIRECT-INDIRECT

Familia	Instalación	Formato	Lm LED/m	Óptica	IRC	K	Equipo	Acabados
F31	SF Surface	084 840mm	LO 1470lm	IO Dir./Ind Opal	8 80	30 3000 K	N ON/OFF	B Black 02
		112 1120mm	MO 2650lm					
		140 1400mm						
		168 1680mm						
		196 1960mm						
		224 2240mm						
		084 840mm	LO 1470lm	IC Dir/Ind Opal Comfort	8 80	30 3000 K	N ON/OFF	B Black 02
		112 1120mm	MO 2650lm					
		140 1400mm						
		168 1680mm						
F31	SF	084	LO	IO	8	30	N	B





Fil 35
Corner

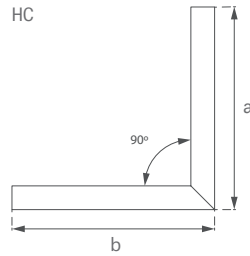
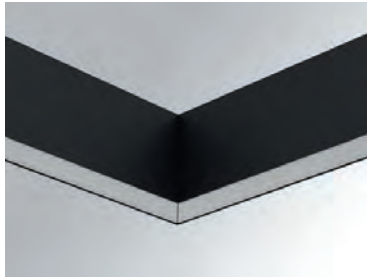

HC	a (mm)	b (mm)
SF	303	303
RE	313	313
TR	311	311

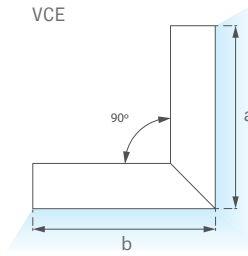

VCE	a (mm)	b (mm)
SF	305	305
RE	305	305
TR	305	305

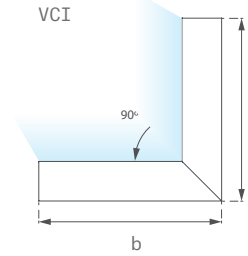

VCI	a (mm)	b (mm)
SF	354	654
RE	350	350
TR	350	350

FIL 35 CORNER

Familia	Instalación	Formato	Lm LED/m	Óptica	IRC	K	Equipo	Acabados
F31	SF Surface RE Recessed	HC Horizontal Corner	LO 1470lm	OP Opal OC Opal Comfort	8 80	30 3000 K 40 4000 K	N ON/OFF D DALI	B Black 02 W White 02 G Grey 01
		VCI Vertical Corner Interior VCE Vertical Corner Exterior		OP Opal				
	TR Trimless	HC Horizontal Corner	LO 1470lm	OP Opal OC Opal Comfort	8 80	30 3000 K 40 4000 K	N ON/OFF D DALI	W White 02
		VCI Vertical Corner Interior VCE Vertical Corner Exterior		OP Opal				
EX: F31	SF	HC	LO	OP	8	30	N	B



CARACTERÍSTICAS TÉCNICAS

Ópticas

IO

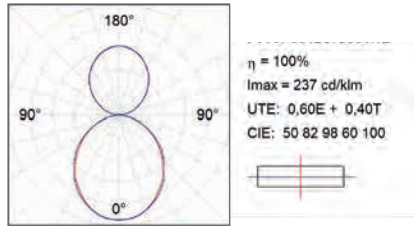

IC

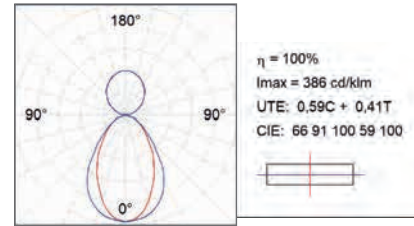

Flujo de salida y potencia

FIL 35 DIRECT-INDIRECT

			K	CRI	840mm		1120mm		1400mm		1680mm		1960mm		2240mm	
					W	lm Output	W	lm Output	W	lm Output	W	lm Output	W	lm Output	W	lm Output
LO	IO	IND	3000	80	7,2	717	7	796	9	995	11	1193	13	1392	14	1591
		DIR			9,6	956	11	1216	14	1520	16	1824	19	2128	22	2432
		IND	4000	80	7,2	617	7	823	9	1028	11	1234	13	1440	14	1645
		DIR			9,6	912	11	1216	14	1520	16	1824	19	2128	22	2432
	IC	IND	3000	80	7,2	679	7	796	9	995	11	1193	-	-	-	-
		DIR			9,6	905	11	1112	14	1390	16	1668	-	-	-	-
MO	IO	IND	3000	80	6	597	7	796	12	995	16	1342	17,8	1938	15	-
		DIR			12	1287	16	1708	18	2135	24,4	2046	27,5	2989	32	-
		IND	4000	80	6	617	7	823	12	1028	14	1234	17	1440	15	-
		DIR			12	1329	16	1772	18	2215	22	2658	25	3101	32	-
	IC	IND	3000	80	6	597	7	795	12	995	14	1193	-	-	-	-
		DIR			12	1179	16	1571	18	1964	22	2357	-	-	-	-
		IND	4000	80	6	617	7	823	12	1028	14	1234	-	-	-	-
		DIR			12	1223	16	1630	18	2038	22	2445	-	-	-	-



ACCESORIOS

Tapa final surface

Ref.	Color
F3SUECB	●
F3SUECW	○
F3SUECG	●

Perfil Superficie max. 3m

Ref.	Color
F3PRSUX/MMB	●
F3PRSUX/MMW	○
F3PRSUX/MMG	●

Tapa final recessed

Ref.	Color
F3REECB	●
F3REECW	○
F3REECG	●

Perfil Recessed max. 3m

Ref.	Color
F3PRREX/MMB	●
F3PRREX/MMW	○
F3PRREX/MMG	●

Tapa final trimless

Ref.	Color
F3TRECW	○

Perfil Trimless max. 3m

Ref.	Color
F3PRTRX/MMW	○

Tapa max. 3m

Ref.	Color
F3COX/MMB	●
F3COX/MMW	○
F3COX/MMG	●

Difusor de policarbonato opal max. 3m

Ref.	Color
F3DIX/MMOP	○



ACCESORIOS

Juego de 2 fijaciones para unión (1 unit/ref.)



Ref.

F3J0 Surface
F3REJ0 Recessed/Trimless

Unión soporte corto techo 2 unit/ref.



Ref.

F3FX15G

Soporte pared 2 unit/ref.



Ref.

F3FX50G
F3FX50B
F3FX50W

Color

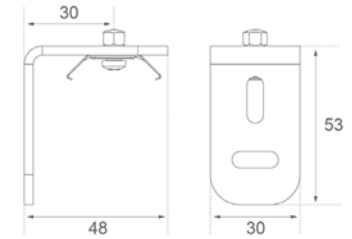



ACCESORIOS

Floron Recessed Basic



Ref.	Color	h(mm)
SUCAREBA1500NB	●	1500
SUCAREBA1500NW	○	1500
SUCAREBA3000NB	●	3000
SUCAREBA3000NW	○	3000
DALI		
SUCAREBA1500DB	●	1500
SUCAREBA1500DW	○	1500
SUCAREBA3000DB	●	3000
SUCAREBA3000DW	○	3000

Floron Surface Basic



Ref.	Color	h(mm)
SUCASFBA1500NB	●	1500
SUCASFBA1500NW	○	1500
SUCASFBA3000NB	●	3000
SUCASFBA3000NW	○	3000
DALI		
SUCASFBA1500DB	●	1500
SUCASFBA1500DW	○	1500
SUCASFBA3000DB	●	3000
SUCASFBA3000DW	○	3000

Floron Recessed Deco



Ref.	Color	h(mm)
SUCAREDE1500NB	●	1500
SUCAREDE1500NW	○	1500
SUCAREDE3000NB	●	3000
SUCAREDE3000NW	○	3000
DALI		
SUCAREDE1500DB	●	1500
SUCAREDE1500DW	○	1500
SUCAREDE3000DB	●	3000
SUCAREDE3000DW	○	3000

Floron Surface Deco



Ref.	Color	h(mm)
SUCASFDE1500NB	●	1500
SUCASFDE1500NW	○	1500
SUCASFDE3000NB	●	3000
SUCASFDE3000NW	○	3000
DALI		
SUCASFDE1500DB	●	1500
SUCASFDE1500DW	○	1500
SUCASFDE3000DB	●	3000
SUCASFDE3000DW	○	3000

Cable de acero regulable



Ref.	Color	h(mm)
F42SUWIDE1500G	●	1500
F42SUWIDE3000G	●	3000

Anclaje desde el extremo

Cable de acero regulable para conexión electromecánica (3 o 5xø1,5)



Ref.	Color	h(mm)
F42SUCAEMF1500NB	●	1500
F42SUCAEMF1500NW	○	1500
F42SUCAEMF3000NB	●	3000
F42SUCAEMF3000NW	○	3000
DALI		
F42SUCAEMF1500DB	●	1500
F42SUCAEMF1500DW	○	1500
F42SUCAEMF3000DB	●	3000
F42SUCAEMF3000DW	○	3000

Anclaje desde el extremo



Fil 45



PRESENTACIÓN FAMILIA

Ind.



Fil 45
Opal

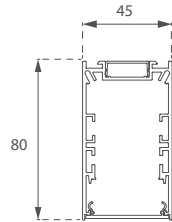

Fil 45
Opal Comfort

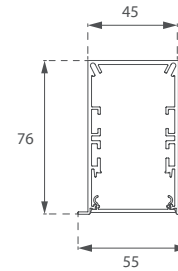

Fil 45
Tech

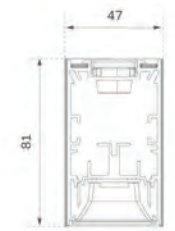

FIL 45 DIRECT

Familia	Instalación	Formatos	Lm LED/m	Óptica	IRC	K	Equipo	Acabados
F41	SF Surface RE Recessed	084 840mm	MO 2320lm HO 4288lm	OP Opal	8 80	30 3000 K 40 4000 K	N ON/OFF D DALI	B Black 02 W White 02 G Grey 01
		112 1120mm						B Black 02 W White 02
		140 1400mm						
		168 1680mm						
	MO 2320lm	PR Opal Comfort	084 840mm	8 80 9 90				B Black 02 W White 02
			112 1120mm					
			140 1400mm					
			168 1680mm					
	MO 2320lm	OP Opal	112 1120mm	8 80	TW Tunable White	D DALI		B Black 02 W White 02 G Grey 01
			168 1680mm					
			224 2240mm					
			MO 2320lm					PR Opal Comfort
168 1680mm								
F41	SF	084	MO	OP	8	30	N	B

FIL 45 TECH G2

Familia	Instalación	Formatos	Lm LED/m	Óptica	IRC	K	Equipo	Acabados
F42	SF Surface RE Recessed	084 840mm	MO 2320lm	TE Tech TA Tech Asym	9 90	30 3000 K 40 4000 K	N ON/OFF D DALI	B Black 02 W White 02 G Grey 01
		112 1120mm						
		140 1400mm						
		168 1680mm						
		196 1960mm						
		224 2240mm						
F41	SF	112	MO	TE	9	30	N	B

WB FIL 45 DIRECT WELLBEING

Familia	Instalación	Formatos	Lm LED/m	Óptica	K	Equipo	Acabados
F41	SF Surface RE Recessed	112 1120mm	MO 2320lm	PR Opal Comfort	WB3 3000 WB WB4 4000 WB	N ON/OFF D DALI	B Black 02 W White 02 G Grey 01
		168 1680mm					
		WB3 3000 WB WB4 4000 WB					D DALI
					WB3 Tunable White WB	D DALI	
F41	SF	112	MO	PR	WB3	N	B





CARACTERÍSTICAS TÉCNICAS

Ópticas

OPAL

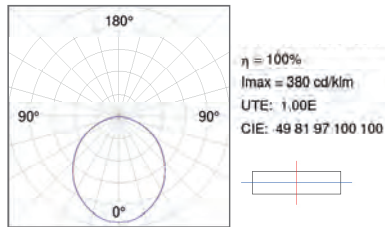

OPAL COMFORT

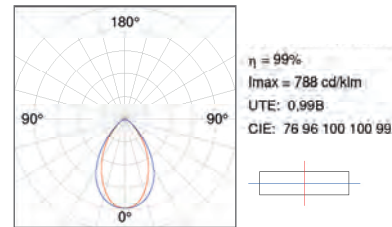

TECH TE

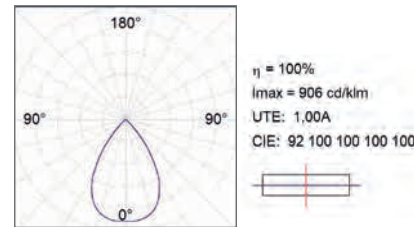

TECH TA

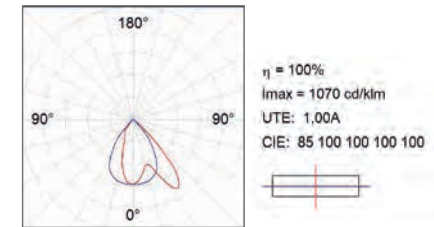

Flujo de salida y potencia

FIL 45 DIRECT

				840mm		1120mm		1400mm		1680mm		1960mm		2240mm	
		K	CRI	W	lm Output	W	lm Output	W	lm Output	W	lm Output	W	lm Output	W	lm Output
MO	OP	3000	80	13,3	1292	17,5	1722	20,3	2153	24,7	2583	27,8	3014	37	3444
		4000	80	13,3	1354	17,5	1805	20,3	2257	24,7	2708	27,8	3160	37	3611
MO	PR	3000	80	15,6	1441	20,9	1922	25,9	2401	31	2881	-	-	-	-
		4000	80	15,6	1512	20,9	2017	25,9	2521	31	3026	-	-	-	-
	3000	90	15,6	1210	20,9	1614	25,9	2017	31	2420	-	-	-	-	
	4000	90	15,6	1270	20,9	1694	25,9	2117	31	2542	-	-	-	-	

FIL 45 TECH G2

				840mm		1120mm		1400mm		1680mm		1960mm		2240mm	
		K	CRI	W	lm Output	W	lm Output	W	lm Output	W	lm Output	W	lm Output	W	lm Output
MO	TE	3000	80	12,2	1310	15,5	1746	19	2183	22,3	2620	26	3056	29,7	3493
		4000	80	12,2	1371	15,5	1828	19	2285	22,3	2742	26	3200	29,7	3657
MO	TA	3000	90	12,2	1072	16,3	1429	19,4	1786	22,8	2143	26	2500	29,7	2858
		4000	90	12,2	1122	16,3	1496	19,4	1870	22,8	2244	26	2618	29,7	2992

FIL 45 DIRECT WELLBEING

				1120mm		1680mm	
		K	CRI	W	lm Output	W	lm Output
MO	PR	3000	98	20,6	1610	42,4	2338
		4000	98	20,	1729	42,4	2817



Fil 45
Direct/Indirect

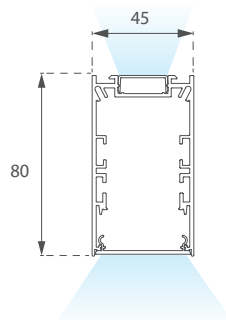
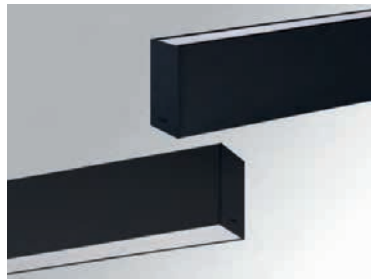

FIL 45 DIRECT-INDIRECT

Familia	Instalación	Formatos	Lm LED/m	Óptica	IRC	K	Equipo	Acabados
F41	SF Surface	084 840mm	MO 2320lm	IO Dir./Ind Opal	8 80	30 3000 K	N ON/OFF	B Black 02
		112 1120mm						
		140 1400mm						
		168 1680mm						
		196 1960mm						
		224 2240mm						
		084 840mm	MO 2320lm	IP Dir./Ind Opal Comfort	8 80	9 90	D DALI	W White 02
		112 1120mm						
		140 1400mm						
		168 1680mm						
F41	SF	084	MO	IO	8	30	N	B

FIL 45 DIRECT-INDIRECT TW

Familia	Instalación	Formatos	Lm LED/m	Óptica	IRC	K	Equipo	Acabados
F41	SF Surface	112 1120mm	MO 2320lm	IO Dir./Ind Opal	8 80	TW Tunable White	D DALI	B Black 02
		168 1680mm						
		224 2240mm						
F41	SF	112	MO	IO	8	TW	D	B

FIL 45 DIRECT-INDIRECT TW WB

Familia	Instalación	Formatos	Lm LED/m	Óptica	IRC	Equipo	Acabados
F41	SF Surface	112 1120mm	MO 2320lm	IP Dir./Ind Opal Comfort	WB Tunable White WB	D DALI	B Black 02
		168 1680mm					
		224 2240mm					
F41	SF	112	MO	IP	WB	D	B





CARACTERÍSTICAS TÉCNICAS

Ópticas

IO

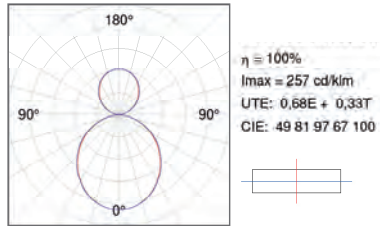

IP

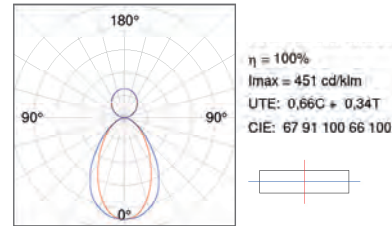

Flujo de salida y potencia

FIL 45 DIRECT/INDIRECT

				840mm		1120mm		1400mm		1680mm		1960mm		2240mm		
		K	CRI	W	lm Output	W	lm Output	W	lm Output	W	lm Output	W	lm Output	W	lm Output	
MO	IO	IND	3000	80	7,9	621	8,7	827	10,7	1034	12,9	1240	15,1	1511	16,45	1654
		DIR	3000	80	14,1	1292	19,6	1723	22,6	2154	27,2	2584	31,4	3146	36,45	3445
		IND	4000	80	7,9	642	8,7	856	10,7	1069	12,9	1284	15,1	1498	16,45	1711
		DIR	4000	80	14,1	1354	19,6	1805	22,6	2257	27,2	2708	31,4	3159	36,45	3611
	IP	IND	3000	80	7,9	606	8,7	807	10,7	1426	12,9	1898	-	-	-	-
		DIR	3000	80	14,1	1487	19,6	1983	22,6	2062	27,2	2288	-	-	-	-
		IND	3000	90	7,9	606	8,7	807	10,7	1426	12,9	2360	-	-	-	-
		DIR	3000	90	14,1	1249	19,6	1665	22,6	1732	27,2	2011	-	-	-	-
		IND	4000	80	7,9	784	8,7	1256	10,7	1785	12,9	2360	-	-	-	-
		DIR	4000	80	14,1	1592	19,6	1912	22,6	2174	27,2	2393	-	-	-	-
		IND	4000	90	7,9	784	8,7	1256	10,7	1785	12,9	2360	-	-	-	-
		DIR	4000	90	14,1	1337	19,6	1606	22,6	1826	27,2	2011	-	-	-	-

FIL 45 DIRECT/INDIRECT TW

				1120mm		1680mm		2240mm		
		K	CRI	W	lm Output	W	lm Output	W	lm Output	
MO	IO	IND	TW	80	30,6	2935	47,2	4403	61,2	5870
		DIR	TW	80	13	1044	18,6	1670	27,12	2088
	IP	IND	TW	80	30,6	2617	47,2	3917	61,2	5233
		DIR	TW	80	13	1044	18,6	1670	27,12	2088

FIL 45 DIRECT/INDIRECT TW WB

				1120mm		1680mm		2240mm		
		K	CRI	W	lm Output	W	lm Output	W	lm Output	
MO	IP	IND	WBT	90	34,3	1612	47,1	2409	68,6	3224
		DIR	WBT	90	13	1044	18,6	1670	27,12	2088



Fil 45
Corner

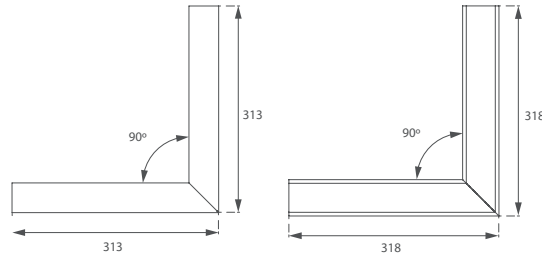

Fil 45
Curve

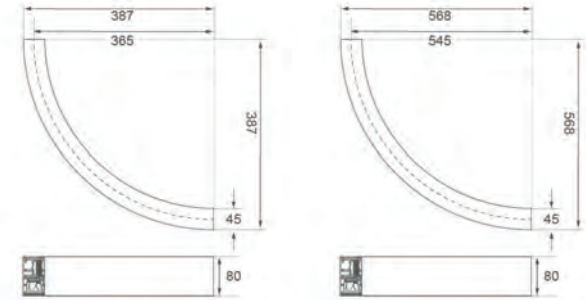

FIL 45 CORNER

Familia	Instalación	Formatos	Lm LED/m	Óptica	IRC	K	Equipo	Acabados
F41	SF Surface RE Recessed	CR Corner	MO 2320lm	OP Opal	8 80	30 3000 K	N ON/OFF D DALI	B Black 02
				PR Opal Comfort		9 90		40 4000 K
F41	SF	CR	MO	OP	8	30	N	B

FIL 45 CURVE

Familia	Instalación	Formatos	Lm LED/m	Óptica	IRC	K	Equipo	Acabados
F41	SF Surface	CC3 Corner Curvo R365mm	MO 2320lm	OP Opal	8 80	30 3000 K	N ON/OFF D DALI	B Black 02
		CC5 Corner Curvo R545mm		PR Opal Comfort		9 90		40 4000 K
F41	SF	CC3	MO	OP	8	30	N	B





CARACTERÍSTICAS TÉCNICAS

Flujo de salida y potencia

FIL 45 CORNER

		90°			
		K	CRI	W	lm Output
MO	OP	3000	80	9,6	861
		4000	80	9,6	903
PR		3000	90	10,9	960
		4000	90	10,9	1009

FIL 45 CURVE

		R365mm				R545mm	
		K	CRI	W	lm Output	W	lm Output
MO	OP	3000	80	9,3	861	13,7	1292
		4000	80	9,3	903	13,7	1355
	PR	3000	90	9,3	739	13,7	1109
		4000	90	9,3	776	13,7	1163
PR		3000	80	9,3	960	13,7	1440
		4000	80	9,3	1009	13,7	1514
		3000	90	9,3	824	13,7	1236
		4000	90	9,3	867	13,7	1300



ACCESORIOS

Tapa final Surface



Ref.

F4SUECB
F4SUECW
F4SUECG

Tapa final Fil Curve

Ref.

F4SFCCECB
F4SFCCECG
F4SFCCECW

Tapa final Recessed

Ref.

F4REECB
F4REECW
F4REECG

Color



Color



Perfil Superficie max. 3m



Ref.

F4PRSUX/MMB
F4PRSUX/MMW
F4PRSUX/MMG

Color



Perfil Recessed max. 3m



Ref.

F4PRREX/MMB
F4PRREX/MMW
F4PRREX/MMG

Color



Tapa max. 3m



Ref.

F4COX/MMB
F4COX/MMW
F4COX/MMG

Color



Difusor de policarbonato opal max. 3m



Ref.

F4DIX/MMOP

Color



Emergency



Ref.

F41EMG3HDWB
F41EMG3HDWW
F41EMG3HDWG

Color



Light Sensor



Ref.

F4LIGHTSNDB
F4LIGHTSNW
F4LIGHTSNDG

Color





ACCESORIOS

Cable de acero regulable



Ref.	Color	h(mm)
F42SUWIDE1500G	●	1500
F42SUWIDE3000G	●	3000

Anclaje desde el extremo

Cable de acero regulable para conexión electromecánica (3 o 5xØ1,5)



Ref.	Color	h(mm)
F42SUCAEMF1500NB	●	1500
F42SUCAEMF1500NW	○	1500
F42SUCAEMF3000NB	●	3000
F42SUCAEMF3000NW	○	3000

DALI

F42SUCAEMF1500DB	●	1500
F42SUCAEMF1500DW	○	1500
F42SUCAEMF3000DB	●	3000
F42SUCAEMF3000DW	○	3000

Anclaje desde el extremo

Cable de acero regulable para Fil Curve



Ref.	Color	h(mm)
F42SUCCWIDE1500G	●	1500
F42SUCCWIDE3000G	●	3000

Anclaje desde el extremo

Fijaciones para unión 1 unit/ref.



Ref.	Color
F42J0	Surface Recessed

Soporte pared 2 unit/ref.



Ref.	Color
F4FX50G	●
F4FX50B	●
F4FX50W	○

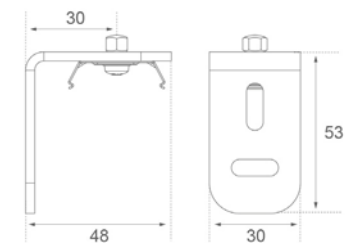

Unión soporte corto techo 2 unit/ref.



Ref.
F4FX15G



ACCESORIOS

Floron Recessed Basic



Ref.	Color	h(mm)
SUCAREBA1500NB	●	1500
SUCAREBA1500NW	○	1500
SUCAREBA3000NB	●	3000
SUCAREBA3000NW	○	3000
DALI		
SUCAREBA1500DB	●	1500
SUCAREBA1500DW	○	1500
SUCAREBA3000DB	●	3000
SUCAREBA3000DW	○	3000

Floron Surface Basic



Ref.	Color	h(mm)
SUCASFBA1500NB	●	1500
SUCASFBA1500NW	○	1500
SUCASFBA3000NB	●	3000
SUCASFBA3000NW	○	3000
DALI		
SUCASFBA1500DB	●	1500
SUCASFBA1500DW	○	1500
SUCASFBA3000DB	●	3000
SUCASFBA3000DW	○	3000

Floron Recessed Deco



Ref.	Color	h(mm)
SUCAREDE1500NB	●	1500
SUCAREDE1500NW	○	1500
SUCAREDE3000NB	●	3000
SUCAREDE3000NW	○	3000
DALI		
SUCAREDE1500DB	●	1500
SUCAREDE1500DW	○	1500
SUCAREDE3000DB	●	3000
SUCAREDE3000DW	○	3000

Floron Surface Deco



Ref.	Color	h(mm)
SUCASFDE1500NB	●	1500
SUCASFDE1500NW	○	1500
SUCASFDE3000NB	●	3000
SUCASFDE3000NW	○	3000
DALI		
SUCASFDE1500DB	●	1500
SUCASFDE1500DW	○	1500
SUCASFDE3000DB	●	3000
SUCASFDE3000DW	○	3000



Fil 50



PRESENTACIÓN FAMILIA

Ind.



Fil 50
Opal



Fil 50
Prismatic

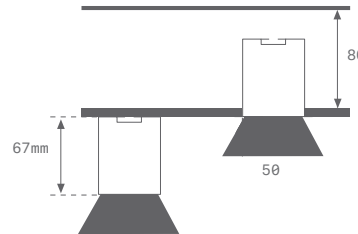

Fil 50
Slim

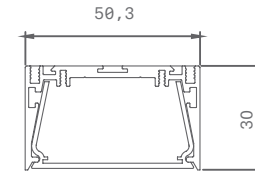
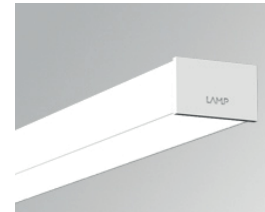

FIL 50

Familia	Instalación	Formato	Lm LED/m	Óptica	IRC	K	Equipo	Acabados
F53	SF Surface RE Recessed	112 1123 mm	MO 2320lm	OP Opal PR Prismatic	8 80	30 3000 K 40 4000 K	N ON/OFF D DALI	W White 02
		168 1683 mm						G Grey 01
		HO 4288lm						OP Opal PR Prismatic
F53	SF	112	MO	OP	8	30	N	W

FIL 50 SLIM

Familia	Instalación	Formato	Lm LED/m	Óptica	IRC	K	Equipo	Acabados
F51	SL Slim	112 1123 mm	MO 2320lm	OC Comfort	8 80	30 3000 K 40 4000 K	N ON/OFF D DALI	W White 02
		168 1683 mm						
F51	SL	112	MO	OP	8	30	N	W

CARACTERÍSTICAS TÉCNICAS

Ópticas

OP

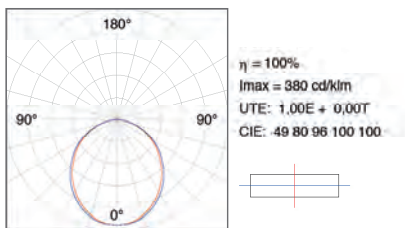

PR

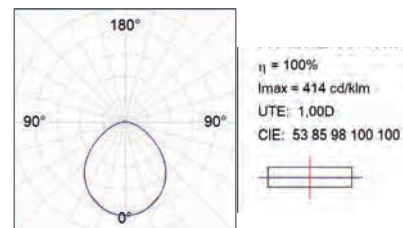

SL

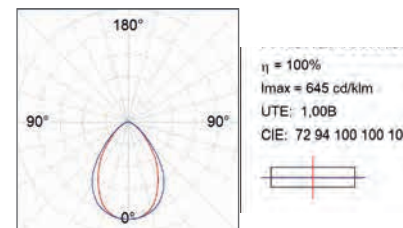



Flujo de salida y potencia

FIL 50

		1123mm				1683mm	
		K	CRI	W	lm Output	W	lm Output
MO	OP	3000	80	21,5	1966	31,2	2994
		4000	80	21,5	2085	31,2	3127
	PR	3000	80	21,5	2315	31,2	3473
		4000	80	21,5	2418	31,2	3627
HO	OP	3000	80	40,1	3846	59,1	5769
		4000	80	40,1	4030	59,1	6045
	PR	3000	80	40,1	4448	59,1	6672
		4000	80	40,1	4660	59,1	6990

FIL 50 SLIM

		1123mm				1683mm	
		K	CRI	W	lm Output	W	lm Output
MO	OC	3000	80	20,9	1922	30,8	2881
		4000	80	20,9	2017	30,8	2036





ACCESORIOS PARA SUPERFICIE

Perfil y tapa Longitud personalizada

Ref.	Color
F5PRSUX/MMG	●
F5PRSUX/MMW	○
F5COX/MMG	●
F5COX/MMW	○

Difusor de policarbonato opal max. 3m

Ref.	Color
F5DIX/MMOP	○

Unión codo 90°

Ref.	Color
F5SUHCG	●
F5REHCW	○

Tapa fina

Ref.	Color
F5SUECG	●
F5SUECW	○

Juego de 2 fijaciones para unión 2 unit/ref.

Ref.
F5J0

Unión codo pared 90°

Ref.	Color
F5SFVCG	●
F7SFVCW	○



ACCESORIOS PARA SUPERFICIE

Tapa final giratoria 2 unit/ref.

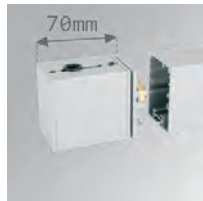

Ref.

F5JOR0EDG
F5JOR0EDW

Color



Pict.



Tapa intermedia giratoria 1 unit/ref



Ref.

F5JOR0IDG
F5JOR0IDW

Color



Pict.



Unión soporte pared 2 unit/ref.



Ref.

F5FX75G
F5FX75W

Color



Lm

75
75

Soporte pared orientable 2 unit/ref.

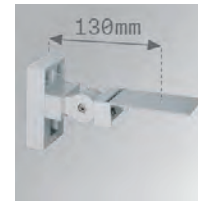

Ref.

ARR013G
ADRD170B

Color



Soporte perpendicular para pared



Ref.

F5PRFXGR

Pulsera electrostática



Ref.

ELWRST



ACCESORIOS PARA EMPOTRAR

Perfil y tapa Longitud personalizada



Ref.	Color
F5PRREX/MMG	●
F5PRREX/MMW	○
F5COX/MMG	●
F5COX/MMW	○

Difusor de policarbonato opal max. 3m



Ref.	Color
F5DIX/MMOP	○

Juego de 2 fijaciones para unión 2 unit/ref.



Ref.
F5J0

Unión codo 90°

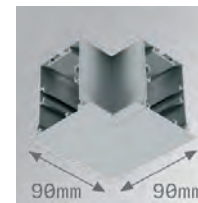

Ref.	Color
F5REHCG	●
F5REHCW	○

Tapa final

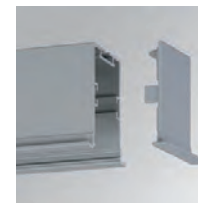

Ref.	Color
F5REECG	●
F5REECW	○

Pulsera electrostática



Ref.
ELWRST



ACCESORIOS

Floron Recessed Basic



Ref.	Color	h(mm)
SUCAREBA1500NB	●	1500
SUCAREBA1500NW	○	1500
SUCAREBA3000NB	●	3000
SUCAREBA3000NW	○	3000
DALI		
SUCAREBA1500DB	●	1500
SUCAREBA1500DW	○	1500
SUCAREBA3000DB	●	3000
SUCAREBA3000DW	○	3000

Floron Surface Basic



Ref.	Color	h(mm)
SUCASFBA1500NB	●	1500
SUCASFBA1500NW	○	1500
SUCASFBA3000NB	●	3000
SUCASFBA3000NW	○	3000
DALI		
SUCASFBA1500DB	●	1500
SUCASFBA1500DW	○	1500
SUCASFBA3000DB	●	3000
SUCASFBA3000DW	○	3000

Floron Recessed Deco



Ref.	Color	h(mm)
SUCAREDE1500NB	●	1500
SUCAREDE1500NW	○	1500
SUCAREDE3000NB	●	3000
SUCAREDE3000NW	○	3000
DALI		
SUCAREDE1500DB	●	1500
SUCAREDE1500DW	○	1500
SUCAREDE3000DB	●	3000
SUCAREDE3000DW	○	3000

Floron Surface Deco



Ref.	Color	h(mm)
SUCASFDE1500NB	●	1500
SUCASFDE1500NW	○	1500
SUCASFDE3000NB	●	3000
SUCASFDE3000NW	○	3000
DALI		
SUCASFDE1500DB	●	1500
SUCASFDE1500DW	○	1500
SUCASFDE3000DB	●	3000
SUCASFDE3000DW	○	3000

Cable de acero regulable



Ref.	Color	h(mm)
F52SUWIDE1500G	●	1500
F52SUWIDE3000G	●	3000

Anclaje desde el extremo

Cable de acero regulable para conexión electromecánica (3 o 5xø1,5)



Ref.	Color	h(mm)
F52SUCAEMF1500NB	●	1500
F52SUCAEMF1500NW	○	1500
F52SUCAEMF3000NB	●	3000
F52SUCAEMF3000NW	○	3000
DALI		
F52SUCAEMF1500DB	●	1500
F52SUCAEMF1500DW	○	1500
F52SUCAEMF3000DB	●	3000
F52SUCAEMF3000DW	○	3000

Anclaje desde el extremo



Fil 70

Fil 70
Opal

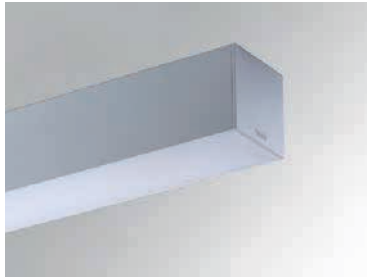

Fil 70
Prismatic

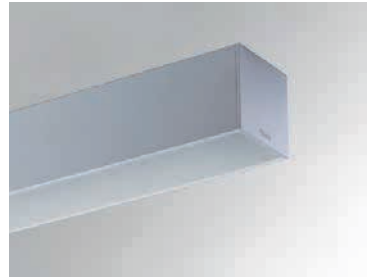

Fil 70
Corner

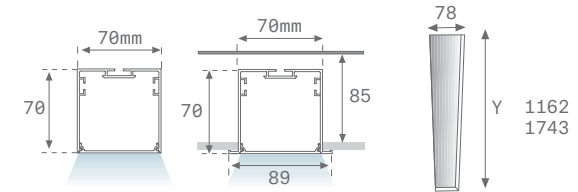

FIL 70

Familia	Formato	Instalación	Formato	Lm LED/m	Óptica	IRC	K	Equipo	Acabados
F71	-	SF Surface	120 1162 mm	LO 2200lm	OP Opal	8 80	30 3000 K	N ON/OFF	W White 02
	-	RE Recessed	170 1743 mm	HO 3800lm	PR Prismatic	8 80	40 4000 K	D DALI	G Grey 01
HC Horizontal Corner	-	SF Surface	-	LO 2200lm	OP Opal	8 80	30 3000 K	N ON/OFF	W White 02
	-	RE Recessed	-	HO 3800lm	OP Opal	8 80	40 4000 K	N ON/OFF	G Grey 01
F71		SF	120	LO	OP	8	30	N	W

CARACTERÍSTICAS TÉCNICAS

Ópticas

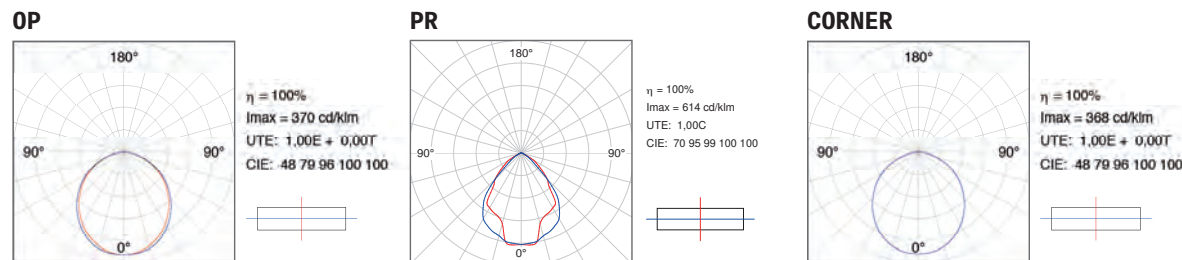

Flujo de salida y potencia

FIL 70		1162mm		1743mm			
	K	CRI	W	lm Output	W	lm Output	
LO	OP	3000	80	17	1992	25	2988
	OP	4000	80	17	2143	25	3215
PR	OP	3000	80	17	2219	25	3328
	OP	4000	80	17	2300	25	3450
HO	OP	3000	80	28	3370	41	5055
	OP	4000	80	28	3545	41	5318
PR	OP	3000	80	28	3507	41	5260
	OP	4000	80	28	3635	41	5452





Fil 70
Direct/Indirect

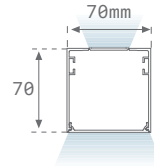
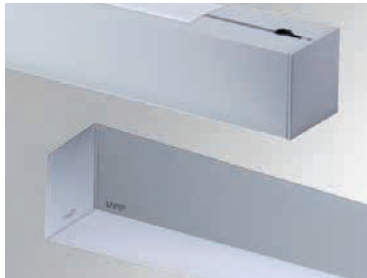

FIL 70 DIRECT INDIRECT

Familia	Instalación	Formato	Lm LED	Óptica	IRC	K	Equipo	Acabados
F71	SF Suspended	120 1162mm	M0 3300	I0 Dir-Indir Opal	8 80	30 3000 K 40 4000 K	N ON/OFF	W White 02
		170 1743mm						G Grey 01
F71	SF	120	M0	I0	8	30	N	W

CARACTERÍSTICAS TÉCNICAS

Ópticas

I0

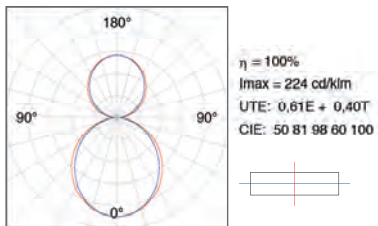

Flujo de salida y potencia

FIL 70 DIRECT/INDIRECT

	K	CRI	120mm		170mm	
			W	lm Output	W	lm Output
IO	3000	80	11,1	1069	15,8	1770
	3000	80	19	1806	26	2907
	4000	80	11,1	1244	15,8	1899
	4000	80	19	2101	26	3119





Fil 70 Tech Symmetric

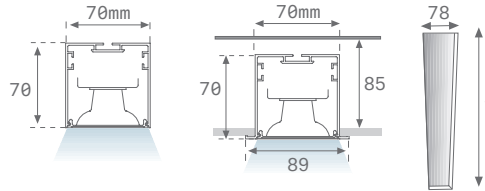

Fil 70 Tech Asymmetric

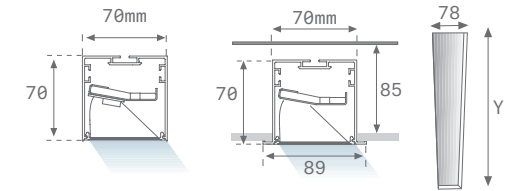

FIL 70 TECH

Familia	Instalación	Formato	Lm LED/m	Óptica	IRC	K	Equipo	Acabados
F71	SF Surface	100 1000 mm	LO 1600lm	TS Tech Symmetric TA Tech Asymmetric	8 80	30 3000 K 40 4000 K	N ON/OFF D DALI	W White 02 G Grey 01
	RE Recessed	200 2000 mm	MO 3200lm HO 6400lm					
F71	SF	100	LO	TA	8	30	N	W

CARACTERÍSTICAS TÉCNICAS

Ópticas

TS

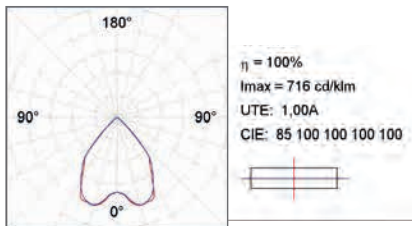

TA

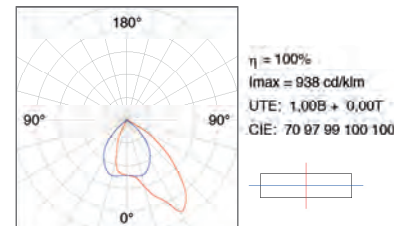

Flujo de salida y potencia

FIL 70 TECH		1000mm		2000mm			
		K	CRI	W	lm Output	W	lm Output
LO	TS	3000	80	14,5	1530	-	-
		4000	80	12	1812	-	-
	TA	3000	80	12	1388	-	-
		4000	80	12	1388	-	-
MO	TS	3000	80	23,6	2400	26,8	3060
		4000	80	21	2872	25	3060
	TA	3000	80	23,6	2032	25	2776
		4000	80	21	2032	25	2776
HO	TS	3000	80	-	-	44,7	4800
		4000	80	-	-	42	4800
	TA	3000	80	-	-	42	4064
		4000	80	-	-	42	4064





ACCESORIOS PARA SUPERFICIE

Perfil y tapa Longitud personalizada

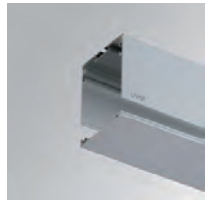

Ref.	Color
F7PRSUX/MMG	●
F7PRSUX/MMW	○
F7COSUX/MMG	●
F7COSUX/MMW	○

Difusor de policarbonato opal max. 3m

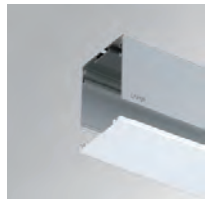

Ref.	Color
F7DIX/MMOP	○

Codo 90° para pared



Ref.	Color
F7SFVCG	●
F7SFVCW	○

ACCESORIOS PARA SUSPENSIÓN

Unión codo 90°

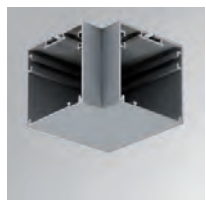

Ref.	Color
F7TESUHCG	●
F7TESUHCW	○

Tapa final

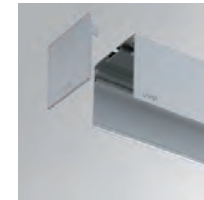

Ref.	Color
F7SUECG	●
F7SUECW	○

Juego de 2 fijaciones para unión 2 unit/ref.



Ref.
F7J0

Codo 90° con difusor policarbonato

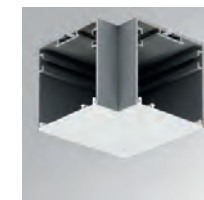

Ref.	Color
F7SUHCG	●
F7SUHCW	○



ACCESORIOS PARA EMPOTRAR

Tapa final

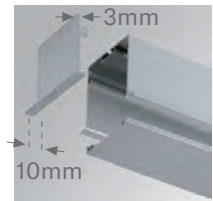

Ref.	Color
F7REECG F7REECW	● ○

Perfil y tapa Longitud personalizada

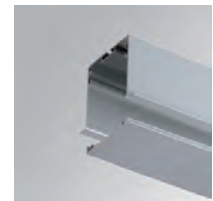

Ref.	Color
F7PRREX/MMG F7PRREX/MMW F7COSUX/MMG F7COSUX/MMW	● ○ ● ○

Codo 90° con difusor policarbonato

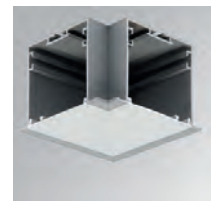

Ref.	Color
F7REHCG F7REHCW	● ○

ACCESORIOS

Pulsera electrostática



Ref.
ELWRST

Juego de 2 fijaciones para unión 2 unit/ref.



Ref.
F7J0

Unión codo 90°

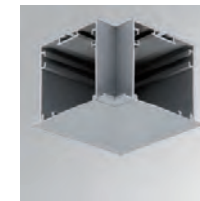

Ref.	Color
F7TEREHCG F7TEREHCW	● ○

Soft Tech Opal 3 unit/ref.



Ref.	Lmm	unit
DIOPST1000	1000	1
	2000	2



ACCESORIOS

Floron Recessed Basic



Ref.	Color	h(mm)
SUCAREBA1500NB	●	1500
SUCAREBA1500NW	○	1500
SUCAREBA3000NB	●	3000
SUCAREBA3000NW	○	3000
DALI		
SUCAREBA1500DB	●	1500
SUCAREBA1500DW	○	1500
SUCAREBA3000DB	●	3000
SUCAREBA3000DW	○	3000

Floron Surface Basic



Ref.	Color	h(mm)
SUCASFBA1500NB	●	1500
SUCASFBA1500NW	○	1500
SUCASFBA3000NB	●	3000
SUCASFBA3000NW	○	3000
DALI		
SUCASFBA1500DB	●	1500
SUCASFBA1500DW	○	1500
SUCASFBA3000DB	●	3000
SUCASFBA3000DW	○	3000

Floron Recessed Deco



Ref.	Color	h(mm)
SUCAREDE1500NB	●	1500
SUCAREDE1500NW	○	1500
SUCAREDE3000NB	●	3000
SUCAREDE3000NW	○	3000
DALI		
SUCAREDE1500DB	●	1500
SUCAREDE1500DW	○	1500
SUCAREDE3000DB	●	3000
SUCAREDE3000DW	○	3000

Floron Surface Deco



Ref.	Color	h(mm)
SUCASFDE1500NB	●	1500
SUCASFDE1500NW	○	1500
SUCASFDE3000NB	●	3000
SUCASFDE3000NW	○	3000
DALI		
SUCASFDE1500DB	●	1500
SUCASFDE1500DW	○	1500
SUCASFDE3000DB	●	3000
SUCASFDE3000DW	○	3000

Cable de acero regulable



Ref.	Color	h(mm)
F52SUWIDE1500G	●	1500
F52SUWIDE3000G	●	3000

Anclaje desde el extremo

Cable de acero regulable para conexión electromecánica (3 o 5xø1,5)



Ref.	Color	h(mm)
F52SUCAEMF1500NB	●	1500
F52SUCAEMF1500NW	○	1500
F52SUCAEMF3000NB	●	3000
F52SUCAEMF3000NW	○	3000
DALI		
F52SUCAEMF1500DB	●	1500
F52SUCAEMF1500DW	○	1500
F52SUCAEMF3000DB	●	3000
F52SUCAEMF3000DW	○	3000

Anclaje desde el extremo

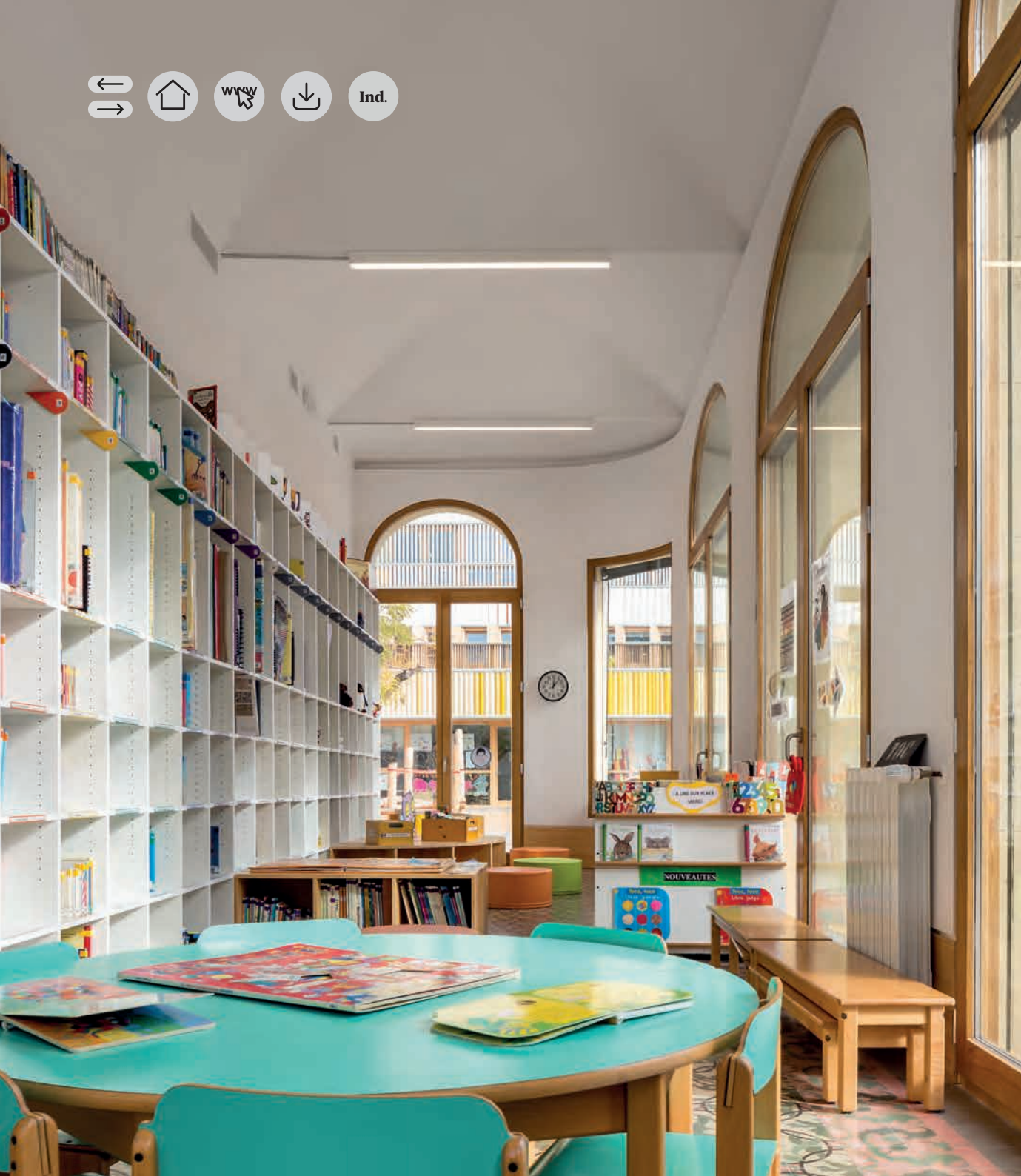

Fil 120

Fil 120

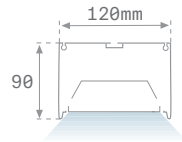

FIL 120

Familia	Instalación	Formato	Lm LED	Óptica	IRC	K	Equipo	Acabados
F121	SF Surface	12 1162mm	HO 6500lm	OP Opal	8 80	30 3000 K 40 4000 K	N ON/OFF D DALI	W White 02
	RE Recessed	17 1743mm						G Grey 01
F121	SF	12	HO	OP	8	30	N	W

Ópticas

OP

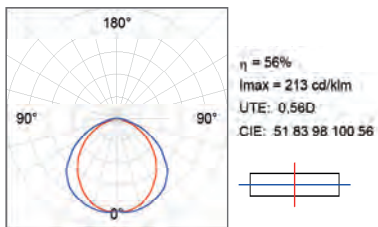

Flujo de salida y potencia

FIL 120

	K	CRI	1162mm		1743mm	
			W	lm Output	W	lm Output
HO	3000	80	49,2	5090	71,7	7735
	4000	80	49,2	5437	71,7	8156



ACCESORIOS PARA EMPOTRAR

Unión codo 90°



Ref.

F12REHCW
F12REHCG

Color



Tapa final de alumini



Ref.

F12REECG
F12REECW

Color



Perfil y apa para empotrar Longitud personalizada

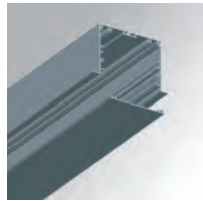

Ref.

F12PRREX/MMG
F12PRREX/MMW
F12COX/MMG
F12COX/MMW

Color



SOPORTES A PARED: Fil 50, Fil 70, Fil 120, Lamptub (1unit/ref.)

Unión soporte corto pared 2 unit/ref.

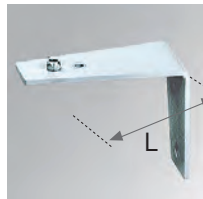

Ref.

F5FX75W
F5FX75G

Color



Lmm

75
75

Juego de 2 fijaciones para unión



Ref.

F7J0

Soporte pared orientable 2 unit/ref.



Ref.

ARRO13W
ARRO13G

Color

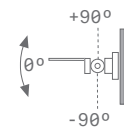

Soporte pared orientable y extensible 2 unit/ref.

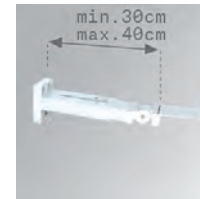

Ref.

ARROEX40W
ARROEX40G

Color

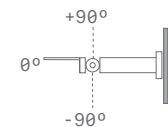

ACCESORIOS PARA SUPERFICIE

Perfil y tapa Longitud personalizada

	Ref.	Color
	F12PRSUX/MMW	<input type="radio"/>
	F12PRSUX/MMG	<input checked="" type="radio"/>
	F12COX/MMW	<input type="radio"/>
	F12COX/MMG	<input checked="" type="radio"/>

Tapa final de aluminio

	Ref.	Color
	F12SUECW	<input type="radio"/>
	F12SUECG	<input checked="" type="radio"/>

Difusor de policarbonato opal max. 3m

	Ref.	Color
	F12DIX/MMOP	<input type="radio"/>

Codo 90° para pared

	Ref.	Color
	F12SFVCW	<input type="radio"/>
	F12SFVCG	<input checked="" type="radio"/>

Unión codo 90°

	Ref.	Color
	F12SUHCW	<input type="radio"/>
	F12SUHCG	<input checked="" type="radio"/>

Unión "T"

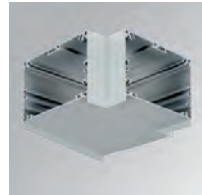
	Ref.	Color
	F12SUTJW	<input type="radio"/>
	F12SUTJG	<input checked="" type="radio"/>

ACCESORIOS PARA SUPERFICIE

Unión "cruz"



Ref.

F12SUXJW
F12SUXJG

Color



Tapa final giratoria



Ref.

F12JOR0EDW
F12JOR0EDG

Color



Tapa intermedia giratoria



Ref.

F12JOR0IDW
F12JOR0IDG

Color





SUSENSIONES: Fil 120, BCN, STGO (1unit/ref.)

Suspensión electromecánica de dos cables acero

Ref.	Color	h(m)
SUEM2W3000NW	○	max. 3
SUEM2W3000NG	●	max. 3

Dos cables acero

Ref.	Color	h(m)
SU2W3000NW	○	max. 3
SU2W3000NG	●	max. 3

Floron Recessed Basic

Ref.	Color	h(mm)
SUCAREBA1500NB	●	1500
SUCAREBA1500NW	○	1500
SUCAREBA3000NB	●	3000
SUCAREBA3000NW	○	3000
DALI		
SUCAREBA1500DB	●	1500
SUCAREBA1500DW	○	1500
SUCAREBA3000DB	●	3000
SUCAREBA3000DW	○	3000

Floron Surface Basic

Ref.	Color	h(mm)
SUCASFBA1500NB	●	1500
SUCASFBA1500NW	○	1500
SUCASFBA3000NB	●	3000
SUCASFBA3000NW	○	3000
DALI		
SUCASFBA1500DB	●	1500
SUCASFBA1500DW	○	1500
SUCASFBA3000DB	●	3000
SUCASFBA3000DW	○	3000

Floron Recessed Deco

Ref.	Color	h(mm)
SUCAREDE1500NB	●	1500
SUCAREDE1500NW	○	1500
SUCAREDE3000NB	●	3000
SUCAREDE3000NW	○	3000
DALI		
SUCAREDE1500DB	●	1500
SUCAREDE1500DW	○	1500
SUCAREDE3000DB	●	3000
SUCAREDE3000DW	○	3000

Floron Surface Deco

Ref.	Color	h(mm)
SUCASFDE1500NB	●	1500
SUCASFDE1500NW	○	1500
SUCASFDE3000NB	●	3000
SUCASFDE3000NW	○	3000
DALI		
SUCASFDE1500DB	●	1500
SUCASFDE1500DW	○	1500
SUCASFDE3000DB	●	3000
SUCASFDE3000DW	○	3000



Fine LED

Fine LED Strip
IP20/65

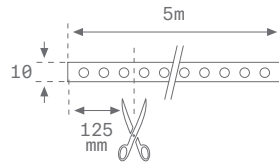

FINE LED STRIP

Familia	Instalación	Formato	Lm LED/m	IP	IRC	K	Equipo
F2	SF Surface	500 5000mm	L0 1500lm	20 20 65 65	8 80 9 90	30 3000 40 4000 TW Tunable White	0 Not Included
F2	SF	500	L0	20	8	30	0

IP20

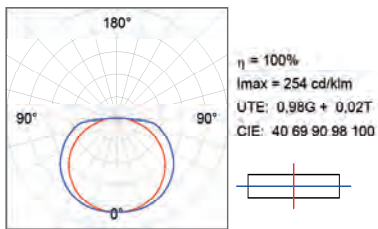

IP65

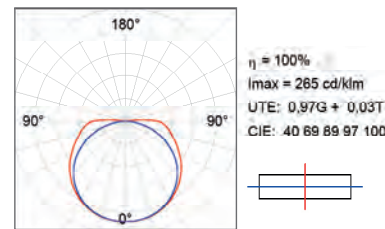

FINE LED STRIP

			5000mm		W/1m	lm Output/1m
	K	CRI	W	lm Output		
LO	3000	80	48	7710	9,6	1542
	4000	80	48	8095	9,6	1619



Esquema On/Off



Esquema DALI

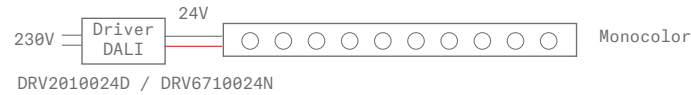

Esquema Dimming

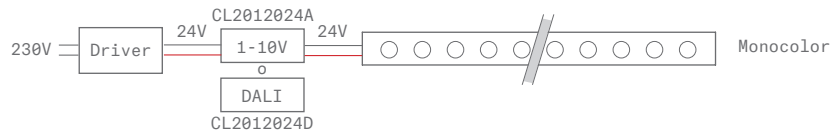

ACCESORIOS

Difusor de policarbonato opal



L 2m
Ref. **FIDI2000OP**

Difusor de policarbonato transparente



L 2m
Ref. **FIDI2000TR**

Perfil y tapas superficie 6 mm



L 2m
Ref.
● **FIPRSU062000N**
● **FISUEC060HG**
● **FISUEC061HG**

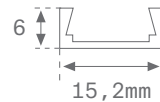

Perfil y tapas para empotrar 6 mm



L 2m
Ref.
● **FIPRE062000N**
● **FIREEC060HG**
● **FIREEC061HG**

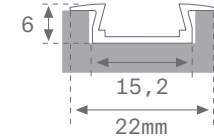

Perfil y tapas superficie 12 mm



L 2m
Ref.
● **FICOSU122000N**
● **FISUEC120HG**
● **FISUEC121HG**

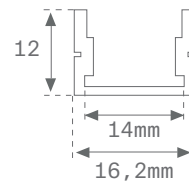

Perfil y tapas para empotrar 12 mm



L 2m
Ref.
● **FIPRE122000N**
● **FIREEC120HG**
● **FIREEC121HG**

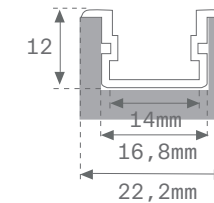

ACCESORIOS

Perfil y tapas para empotrar 12 mm



L	Ref.
2m	● FIC0SU452000N
-	● FISUEC450HG
-	● FISUEC451HG

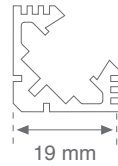

Grapa sujeción perfil inclinación 45° 1 unit. / ref.



Ref.
FISUBR45

Pulsera electrostática



Ref.
ELWRST

Tapa final



Tapa final con agujero de salida para el cable

Grapa sujeción perfil de superficie 1 unit. / ref.



Ref.
FISUBR

Fine Curve

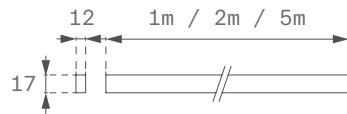

FINE CURVE

Familia	Formato	Lm LED/m	IP	Óptica	IRC	K	Equipo	Acabados
FC2	100 1000mm	L0 500lm	67	0P Opal	9 90	27 2700	0 Not Included	W White
	200 2000mm					30 3000		
	500 5000mm					40 4000		
FC2	100	L0	67	0P	9	30	0	W

CARACTERÍSTICAS TÉCNICAS

Ópticas

0P

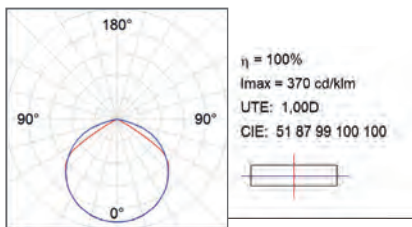

Flujo de salida y potencia

FINE CURVE

	K	CRI	1000mm		2000mm		5000mm	
			W	lm Output	W	lm Output	W	lm Output
0P	2700	90	10	410	20	820	50	2050
	3000	90	10	420	20	840	50	2100
	4000	90	10	450	20	900	50	2250



ACCESORIOS

Grapa sujeción perfil de superficie 1 uni . / ref.



Ref.

FC1FX30G

1mt: 3 unit.
2mts: 5 unit.
5mts: 11 unit.

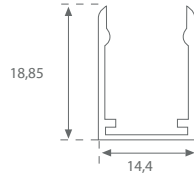

Sujeción flexible superficie 1 uni . /ref

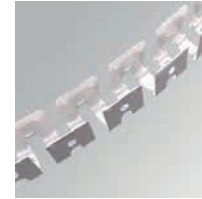

Ref.

FCFX500W



EQUIPOS

Fuente de alimentación LED (Driver)



W	Ref.	V	IP	Reg.
60	DRV20602430N	24	20	ON/OFF
60	DRV206024D	24	20	DALI
20	DRV202024N	24	20	ON/OFF
80	DRV688024N	24	66	ON/OFF
100	DRV2010024D	24	20	DALI
100	DRV6710024N	24	67	ON/OFF
60	DRV676024D	24	67	DALI
75	DRV677524N	24	67	ON/OFF

Conectores 4 polos IP67



Ref.

CT4P67N

Controlador para regulación tiras monocolor (PWM)



W	Ref.	V	Control	Pict.
120	CL2012024A	24	1-10V	
120	CL2012024D	24	DALI	



Hance 48V



Hance 48V
Track 500lm

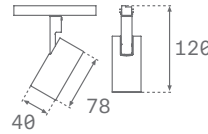

HANCE 48V 500

Familia	Instalación	Lm LED	Ópticas	IRC	K	Equipo	Acabados Acc.	Acabados
HS1	TL Track 48V	05 500lm	SP SP 13° MF MFL 19° FL FL 26°	8 80	27 2700 K 30 3000 K 40 4000 K	N ON/OFF D DALI	B Black	W White 03 B Black 03
HS1	TL	05	SP	8	27	N	B	W

CARACTERÍSTICAS TÉCNICAS

Ópticas

SP 13°

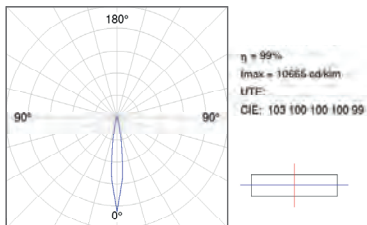

MFL 19°

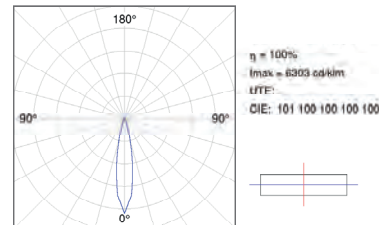

FL 26°

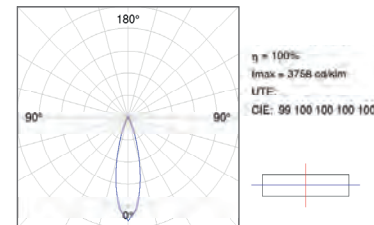

Flujo de salida y potencia

HANCE 48V 500

	K	CRI	500lm	
			W	lm Output
SP 13°	2700	80	6,1	314
	3000	80	6,1	314
	4000	80	6,1	339
MFL 16°	2700	80	6,1	330
	3000	80	6,1	330
	4000	80	6,1	356
FL 26°	2700	80	6,1	324
	3000	80	6,1	324
	4000	80	6,1	349





ACCESORIOS

Difusor transparente



Ref.
HSTR75

Lente Soft



Ref.
HSSL25

Refractor para distribución elíptica del flujo luminoso



Ref.
HSEL25

Rejilla antideslumbrante tipo panel



Ref.
HSO25

Aro Decorativo



Ref.
HSRI65W
HSRI65C
HSRI65M

Color



Recortador de haz



Ref.
HSCU25



Hance 48V
Track 1000/2000lm

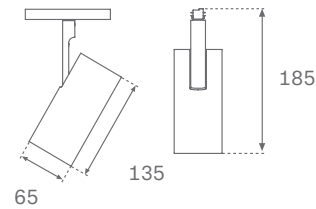

HANCE 48V 1000/2000

Familia	Instalación	Lm LED	Ópticas	IRC	K	Equipo	Acabados Acc.	Acabados
HS1	TL Track 48V	10 700lm	SS SSP 10°	8 80	27 2700 K	N ON/OFF	B Black 01	W White 01
		20 1000lm						B Black 01
		10 1000lm	SP SP 17°	40 4000 K	D DALI			
20 2000lm	MF MFL 23°							
			FL FL 37°					
HS1	TL	10	SS	8	27	N	B	W



CARACTERÍSTICAS TÉCNICAS

Ópticas

SSP 10°

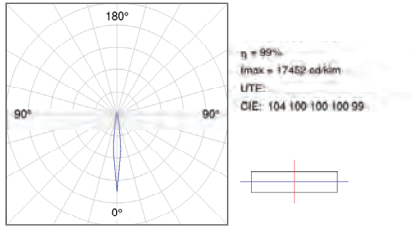

SP 17°

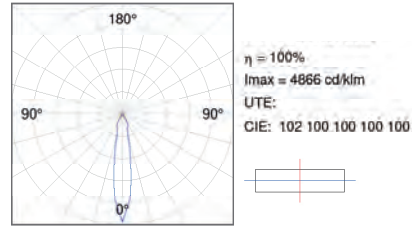

MFL 23°

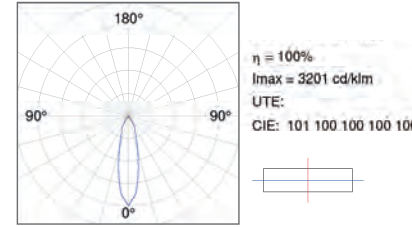

FL 37°

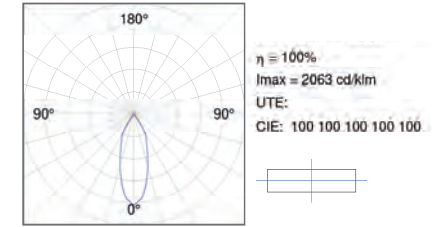

Flujo de salida y potencia

HANCE 48V 700/1000/2000lm

	K	CRI	700lm		1000lm		2000lm	
			W	lm Output	W	lm Output	W	lm Output
SSP 10°	2700	80	9	498	-	-	-	-
	3000	80	9	605	-	-	-	-
	4000	80	9	700	-	-	-	-
SP 17°	2700	80	-	-	9,4	928	16,9	1511
	3000	80	-	-	9,4	947	16,9	1542
	4000	80	-	-	9,4	1003	16,9	1633
MFL 23°	2700	80	-	-	9,4	865	16,9	1281
	3000	80	-	-	9,4	883	16,9	1307
	4000	80	-	-	9,4	935	16,9	1384
FL 37°	2700	80	-	-	9,4	955	16,9	1569
	3000	80	-	-	9,4	974	16,9	1600
	4000	80	-	-	9,4	1032	16,9	1695



ACCESORIOS

Difusor transparente



Ref.

HSTR50

● No se puede montar en modelos SSP

Lente Soft



Ref.

HSSL50

Refractor para distribución elíptica del flujo luminoso



Ref.

HSEL50

Rejilla antideslumbrante tipo panel



Ref.

HSO50

● No se puede montar en modelos SSP

Aro Decorativo



Ref.

HSRI65W
HSRI65C
HSRI65M

Color



Recortador de haz



Ref.

HSCU50



Hance Downlight



DOWNLIGHT

Familia	Instalación	Lm LED	Óptica	IRC	K	Equipo	Acabados
HD2	RE Recessed	07 700lm	SS SSP 10°	9 90	30 3000K	N ON/OFF	W White 03
	SR Semi-Recessed	10 1000lm					
		10 1000lm	SP SP 16°	8 80			
		20 2000lm	MF MFL 23°	9 90			
		30 3000lm	FL FL 34°				
		40 4000lm					
HD2	RE	10	SS	9	30	N	W



Hance Downlight
Recessed 1000/2000lm

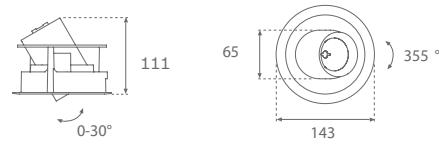

Hance Downlight
Semi-Rec 1000/2000lm

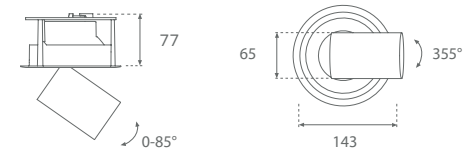

Hance Downlight
Recessed 3000/4000lm

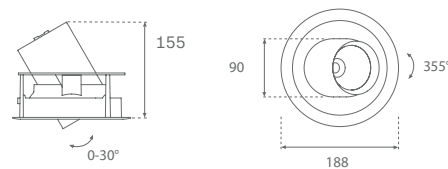

Hance Downlight
Semi Recessed 3000/4000lm

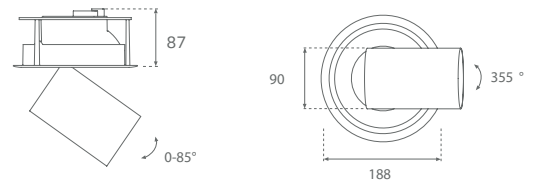



CARACTERÍSTICAS TÉCNICAS

Ópticas

700/1000lm

SSP 10°

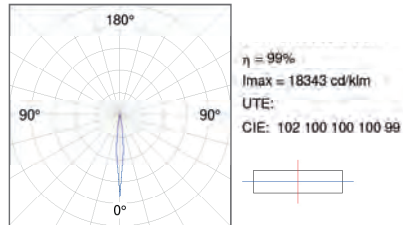

1000/2000lm

SP 16°

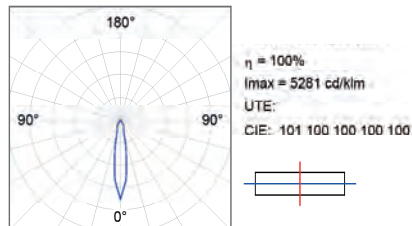

FL 23°

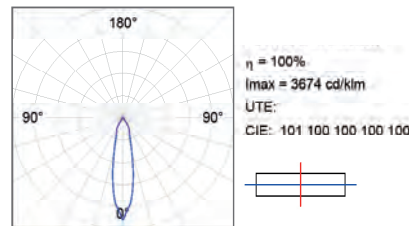

FL 34°

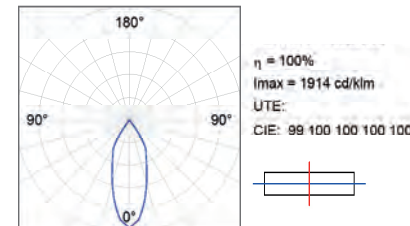

3000/4000lm

SP 16°

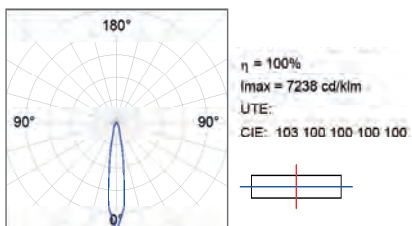

MFL 23°

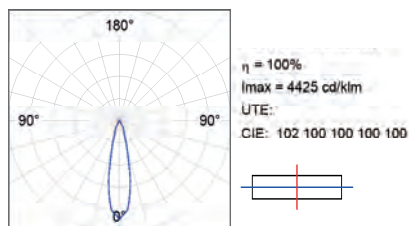

FL 32°

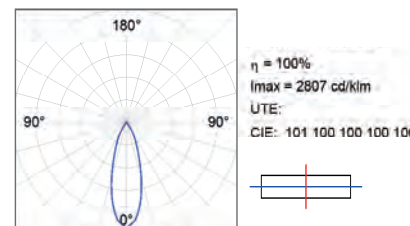



Flujo de salida y potencia

HANCE DOWNLIGHT

	K		700lm		1000lm		2000lm		3000lm		4000lm	
			W	lm Output	W	lm Output	W	lm Output	W	lm Output	W	lm Output
SSP 10°	3000	90	8,6	438	13,9	652	-	-	-	-	-	-
	4000	90	8,6	492	13,9	737	-	-	-	-	-	-
SP 16°	3000	80	-	-	8,6	955	20,8	2204	28,3	3233	36,7	4440
	4000	80	-	-	8,6	1054	20,8	2335	28,3	3419	36,7	4694
	3000	90	-	-	8,6	853	20,8	1889	28,3	2759	36,7	3789
	4000	90	-	-	8,6	899	20,8	1992	28,3	2911	36,7	3994
MFL 23°	3000	80	-	-	8,6	1022	20,8	2267	28,3	3356	36,7	4343
	4000	80	-	-	8,6	1071	20,8	2402	28,3	3549	36,7	4591
	3000	90	-	-	8,6	876	20,8	1943	28,3	2864	36,7	3706
	4000	90	-	-	8,6	924	20,8	2049	28,3	3022	36,7	3907
FL 34°	3000	80	-	-	8,6	1011	20,8	2238	28,3	3138	36,7	4225
	4000	80	-	-	8,6	1083	20,8	2371	28,3	3318	36,7	4467
	3000	90	-	-	8,6	867	20,8	1918	28,3	2978	36,7	3606
	4000	90	-	-	8,6	914	20,8	2022	28,3	2826	36,7	3800



ACCESORIOS

Difusor transparente



Ref.

- HSTR50** - Downlight 700/1000/2000
- HS2TR75** - Downlight 3000/4000

● No se puede montar en modelos SS

Lente Soft



Ref.

- HSSL50** - Downlight 700/1000/2000
- HSSL75** - Downlight 3000/4000

Refractor para distribución elíptica del flujo luminoso



Ref.

- HSEL50** - Downlight 700/1000/2000
- HSEL75** - Downlight 3000/4000

Rejilla antideslumbrante tipo panel

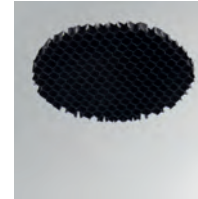

Ref.

- HSH050** - Downlight 700/1000/2000
- HS2H075** - Downlight 3000/4000

● No se puede montar en modelos SS

Aro Decorativo



Ref.

- HSRI65W** - Downlight 700/1000/2000
- HSRI65C** - Downlight 700/1000/2000
- HSRI65M** - Downlight 700/1000/2000

Color



- HS2RI90W** - Downlight 3000/4000
- HS2RI90C** - Downlight 3000/4000
- HS2RI90M** - Downlight 3000/4000



Recortador de haz



Ref.

- HSCU50** - Downlight 700/1000/2000
- HSCU75** - Downlight 3000/4000



Hance Spotlight

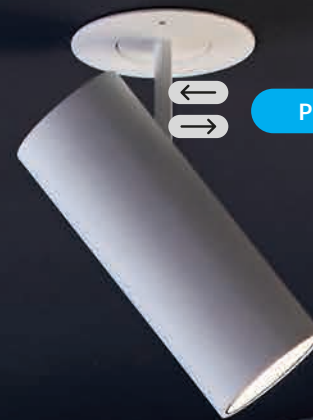

PRESENTACIÓN FAMILIA

Ind.



HANCE SPOTLIGHT

Familia	Instalación	Lm LED	Óptica	IRC	K	Equipo	Acabados
HS2	TK Track	07 700lm	SS SSP 10°	9 90	30 3000 K	N ON/OFF	W White 03
	SF Surface	10 1000lm					
	SR Semi-Recessed	10 1000lm	SP SP 16-17°	8 80			
		20 2000lm	MF MFL 23-24°	9 90			
		30 3000lm	FL FL 36-37°				
		40 4000lm					
HS2	TK	10	SP	8	30	N	W

Hance Spotlight Superspot Track 700-1000



700/1000 ON OFF

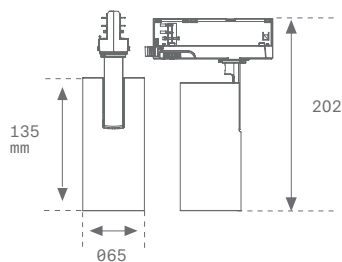

700/1000 DALI

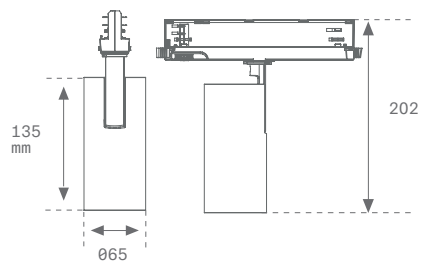

Hance Spotlight Superspot Surface 700-1000



700 ON-OFF

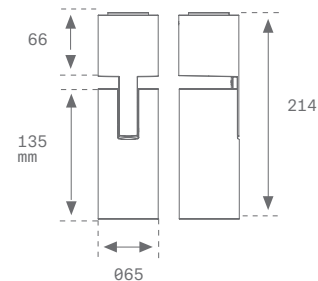

700 DALI - 1000 ON-OFF/DALI

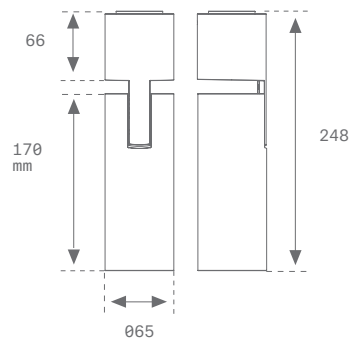

Hance Spotlight Superspot Semi-Rec 700-1000



700/1000 ON-OFF/DALI

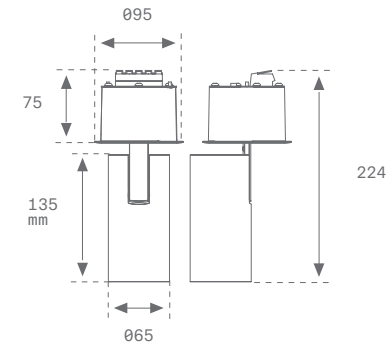

Hance Spotlight Track 1000-2000



1000/2000 ON OFF

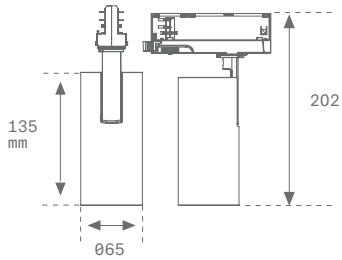

1000/2000 DALI

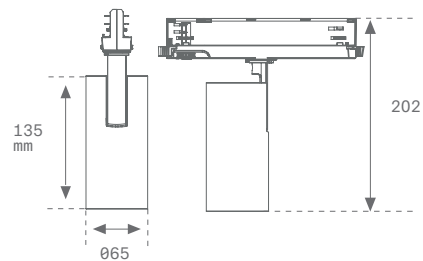

Hance Spotlight Surface 1000-2000



1000 ON-OFF

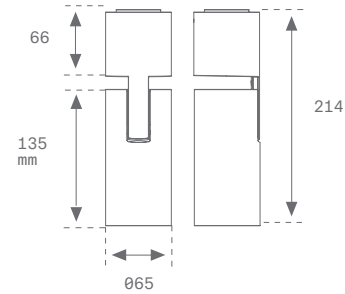

1000 DALI - 2000 ON-OFF/DALI

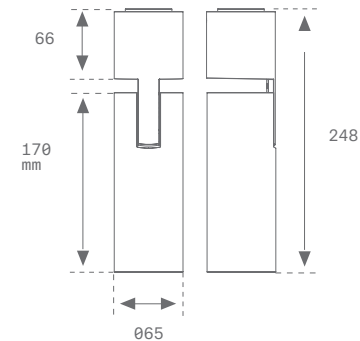

Hance Spotlight Semi-Rec 1000-2000



1000/2000 ON-OFF/DALI

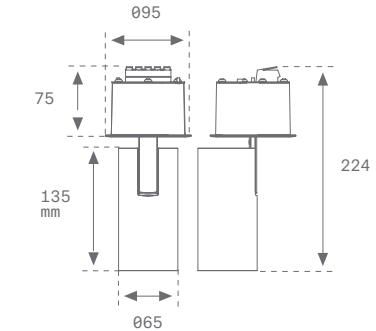



Hance Spotlight
Track 3000-4000



3000/4000 ON OFF

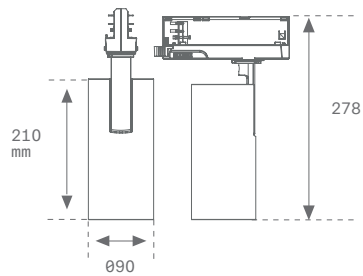

3000/4000 DALI

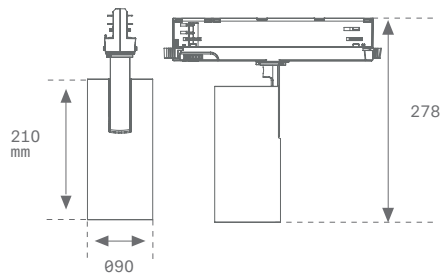

Hance Spotlight
Surface 3000-4000

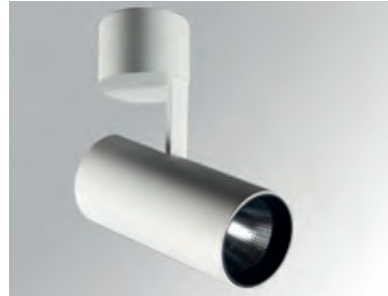

3000/4000 ON OFF/DALI

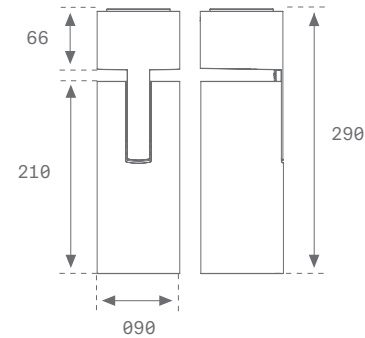

Hance Spotlight
Semi-Rec 3000-4000



3000/4000 ON OFF/DALI

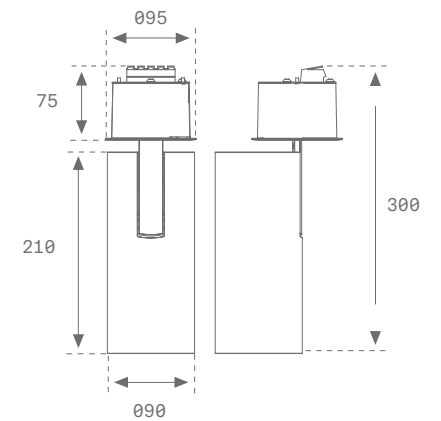



Flujo de salida y potencia

HANCE SPOTLIGHT

	K		700lm		1000lm		2000lm		3000lm		4000lm	
			W	lm Output	W	lm Output	W	lm Output	W	lm Output	W	lm Output
SSP 10°	3000	90	8,6	438	13,9	652	-	-	-	-	-	-
	4000	90	8,6	492	13,9	737	-	-	-	-	-	-
SP 16°	3000	80	-	-	8,6	955	20,8	2204	28,3	3233	36,7	4440
	4000	80	-	-	8,6	1054	20,8	2335	28,3	3419	36,7	4694
	3000	90	-	-	8,6	853	20,8	1889	28,3	2759	36,7	3789
	4000	90	-	-	8,6	899	20,8	1992	28,3	2911	36,7	3994
MFL 23°	3000	80	-	-	8,6	1022	20,8	2267	28,3	3356	36,7	4343
	4000	80	-	-	8,6	1071	20,8	2402	28,3	4549	36,7	4591
	3000	90	-	-	8,6	876	20,8	1943	28,3	2864	36,7	3706
	4000	90	-	-	8,6	924	20,8	2049	28,3	3022	36,7	3907
FL 34°	3000	80	-	-	8,6	1011	20,8	2238	28,3	3138	36,7	4225
	4000	80	-	-	8,6	1083	20,8	2371	28,3	3318	36,7	4467
	3000	90	-	-	8,6	867	20,8	1918	28,3	2978	36,7	3606
	4000	90	-	-	8,6	914	20,8	2022	28,3	2826	36,7	3800

CARACTERÍSTICAS TÉCNICAS

Ópticas

700/1000lm

SSP 10°

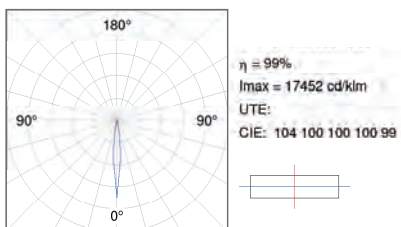

1000/2000lm

SP 16-17°

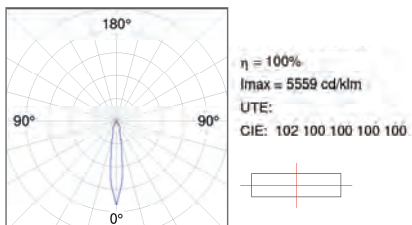

MFL 23-24°

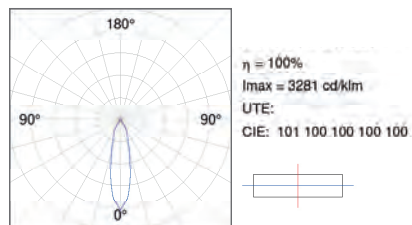

FL 36-37°

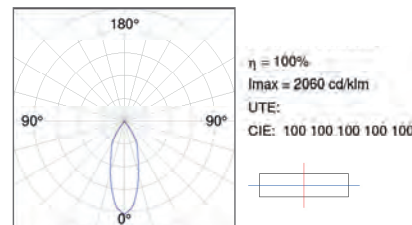

3000/4000lm

SP 16°

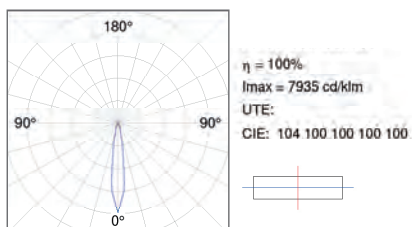

MFL 23°

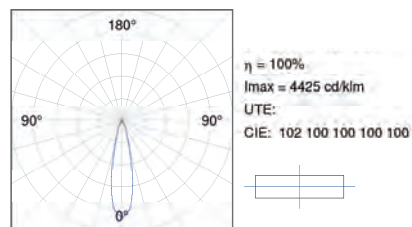

FL 34°

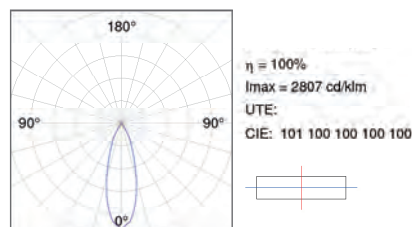



ACCESORIOS

Difusor transparente



Ref.

HSTR50 - Spotlight 700/1000/2000
HS2TR75 - Spotlight 3000/4000

● No se puede montar en modelos SS

Lente Soft



Ref.

HSSL50 - Spotlight 700/1000/2000
HSSL75 - Spotlight 3000/4000

Refractor para distribución elíptica del flujo luminoso



Ref.

HSEL50 - Spotlight 700/1000/2000
HSEL75 - Spotlight 3000/4000

Rejilla antideslumbrante tipo panel

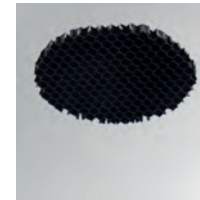

Ref.

HSH050 - Spotlight 700/1000/2000
HS2H075 - Spotlight 3000/4000

● No se puede montar en modelos SS

Aro Decorativo



Ref.

HSRI65W - Spotlight 700/1000/2000
HSRI65C - Spotlight 700/1000/2000
HSRI65M - Spotlight 700/1000/2000

Color



HS2RI90W - Spotlight 3000/4000
HS2RI90C - Spotlight 3000/4000
HS2RI90M - Spotlight 3000/4000



Recortador de haz



Ref.

HSCU50 - Spotlight 700/1000/2000
HSCU75 - Spotlight 3000/4000

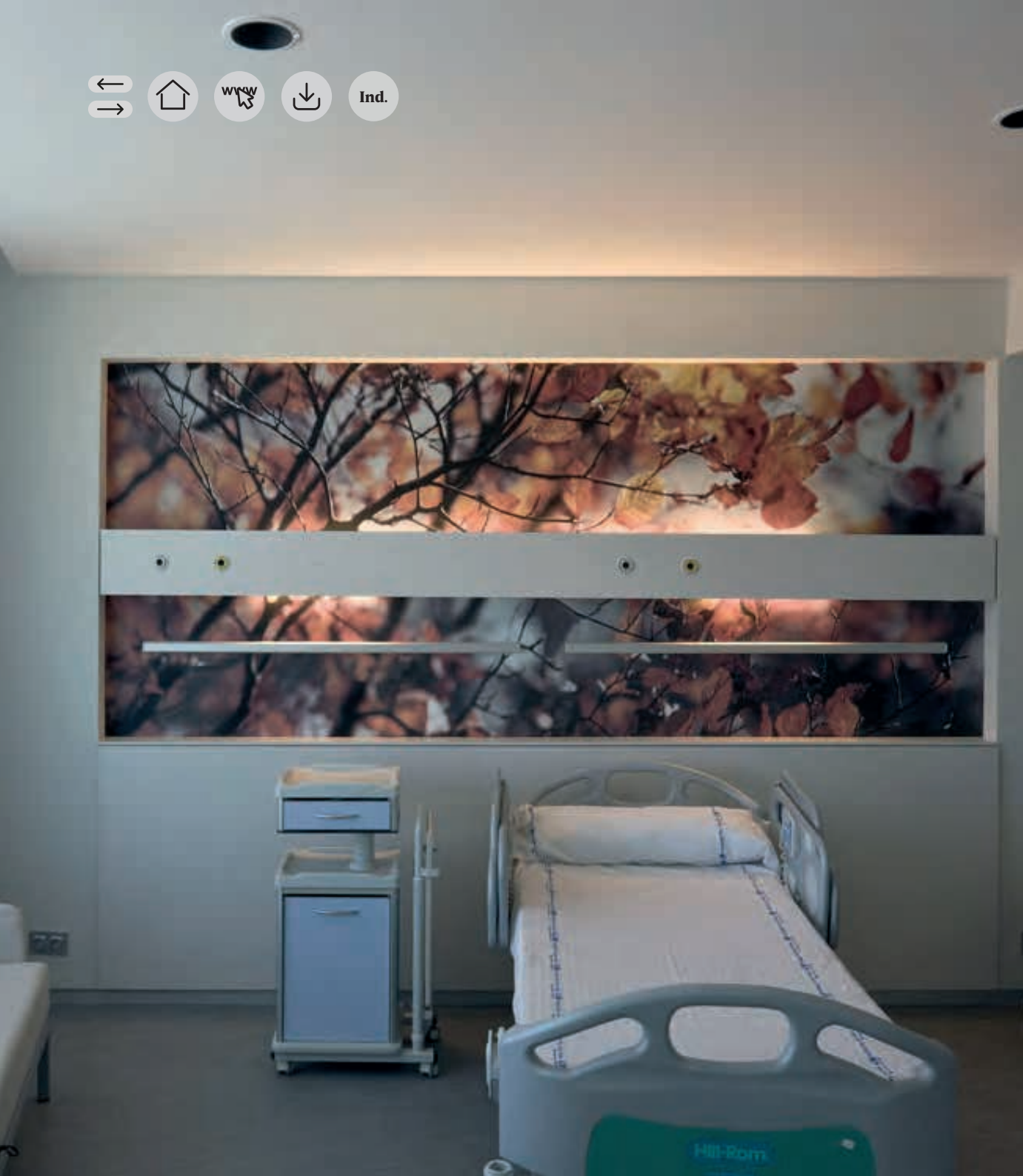

Health & Wellness



Clinic

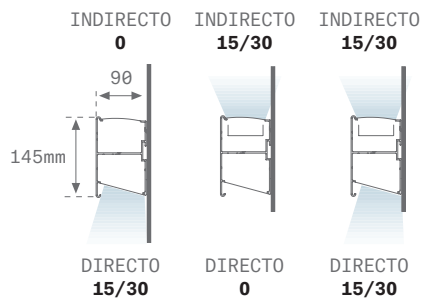
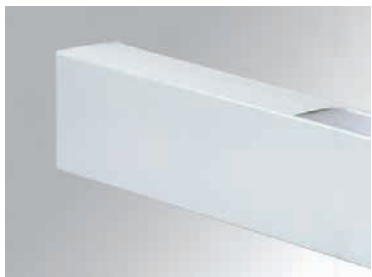

CLINIC

Familia	Formato	Lm LED Dir.	Lm LED Ind.	IRC	K	Equipo	Acabados
CL1	120 1173	15 1620 lm	15 1620 lm	8 80	40 4000 K	N ON/OFF	W White 01
	175 1756	30 3240 lm 15 1620 lm	30 3240 lm 15 1620 lm				
CL1	120	15	15	8	40	N	W

CLINIC TW

Familia	Formato	Óptica	Lm LED	IRC	K	Equipo
CL1	058 1173mm	DR Direct	M0	8 80	TW Tunable White	D DALI
	115 1150mm	ID Indirect				
CL1	058	DR	M0	8	TW	D





CARACTERÍSTICAS TÉCNICAS

Ópticas

DIRECT

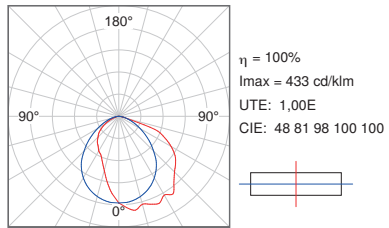

INDIRECT

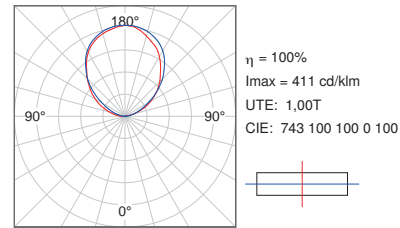

Flujo de salida y potencia

CLINIC

				1173mm		1756mm	
		K	CRI	W	lm Output	W	lm Output
LO	DIR	4000	80	12	1150	12	1150
	IND	4000	80	12	1150	12	1150
	DIR LO / IND LO	4000	80	24	2300	24	2300
LO/HO	DIR LO / IND HO	4000	80	36	3450	36	3450
HO	DIR	4000	80	24	2300	24	2300
	IND	4000	80	24	2300	24	2300

CLINIC TW

				580mm		1150mm	
		K	CRI	W	lm Output	W	lm Output
HO	DIR	TW	80	16,5	1629	31,6	3258
	IND	TW	80	16,5	1716	31,6	3432



Clinic Gas

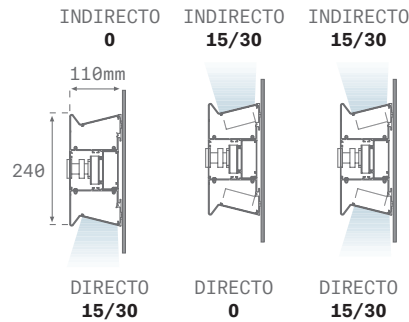

CLINIC GAS

Familia	Formato	Lm LED Dir.	Lm LED Ind.	Toma Gas	IRC	K	Equipo	Acabados
CG1	185 1856	30 3240 lm	30 3240 lm	1 1 ●	8 80	40 4000 K	N ON/OFF	W White 01
		15 1620 lm	15 1620 lm	2 2 ●				
				3 3 ●				
CG1	185	30	30	1	8	40	N	W

CARACTERÍSTICAS TÉCNICAS

DIRECT

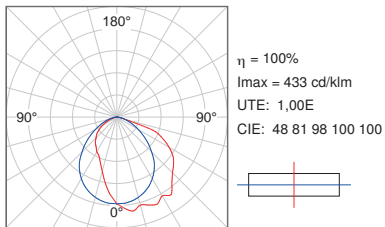

INDIRECT

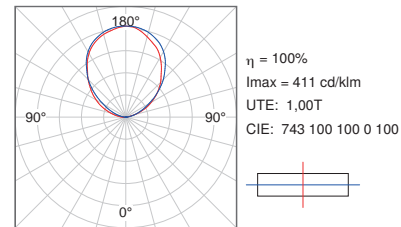

		1856mm											
DIR	LO	Gas	K	CRI	W	lm Output	DIR/IND	DIR HO/IND LO	Gas	K	CRI	W	lm Output
		1G	4000	80	12	1150		1G	4000	80	36	3450	
		2G						2G					
		3G						3G					
	HO	1G	4000	80	24	2300		DIR HO/IND HO	1G	4000	80	48	4600
		2G						2G					
		3G						3G					
	IND LO	1G	4000	80	12	1150							
		2G											
		3G											
	HO	1G	4000	80	24	2300							
		2G											
		3G											





ACCESORIOS

● 1 toma de gases medicinales



Ref.
1

● 2 tomas de gases medicinales

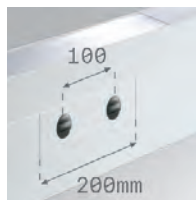

Ref.
2

● 3 tomas de gases medicinales

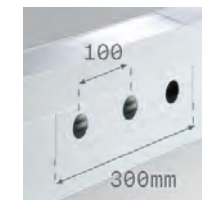

Ref.
3

Interruptor unipolar



Ref.
CLAC1PIN

Color
○

Interruptor unipolar doble



Ref.
CLAC1PDB

Color
○

Base Schuko



Ref.
CLACSK

Color
○

Interruptor conmutado



Ref.
CLAC2PIN

Color
○

Pulsador con tirador



Ref.
CLACTPUSH

Color
○

Base Schuko (Francia)



Ref.
CLACSKFR

Color
○



ACCESORIOS

Interruptor tirador unipolar



Ref.
CLACTSW

Color
○

Placa ciega



Ref.
CLACCO

Color
○

Luz de noche



Ref.
CLACNL

Color
○

Conector RJ-45



Ref.
CLACRJ45

Pulsador a distancia



Ref.
CLACPUSH

Color
○

Pulsador de llamada y de presencia



Ref.
CLACPPUSH

Color
○

Control remoto



Ref.
CLACRC

Color
○



Hermética

Hermética

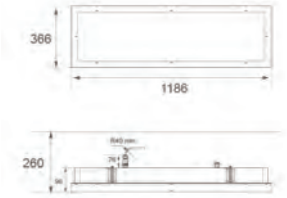
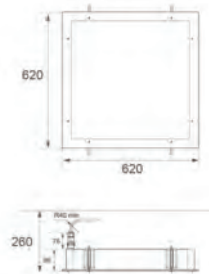

HERMÉTICA

Familia	Formato	Lm LED	IP	Óptica	IRC	K	Equipo	Acabados
HM2	060 600x600mm	55 5600lm	65 IP65	OP Opal	8 80	30 3000 K	N ON-OFF	W White 04
	120 1200x300mm			PR Prismatic		40 4000 K		
HM2	060	55	65	OP	8	40	D	W

OP

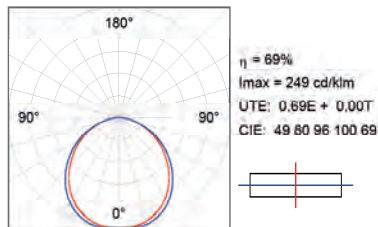

PR

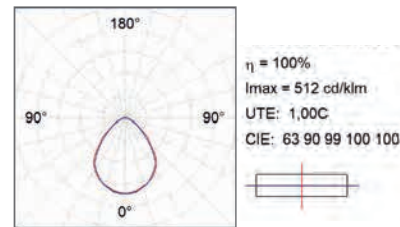

	600x600mm				1200x300mm	
	K	CRI	W	lm Output	W	lm Output
OP	3000	80	35	4390	35	4390
	4000	80	35	4600	35	4600
PR	3000	80	35	4328	35	4328
	4000	80	35	4535	35	4535





Imag



Imag G3
Track

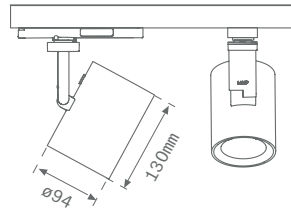

IMAG G3

Familia	Formato	Lm LED	Óptica	IRC	K	Equipo	Acabados
IM3	TK Track	20 2000lm	SP SP 15°-20°	9 90	30 3000 K	N ON/OFF	W White 05
		30 3000lm	MF MFL 22°-26°		40 4000 K		B Black 05
		40 4000lm	FL FL 33°-36°				
			WF WFL 56°-57°				
IM3	TK	20	SP	9	30	N	W



CARACTERÍSTICAS TÉCNICAS

Ópticas

SP 15°-20°

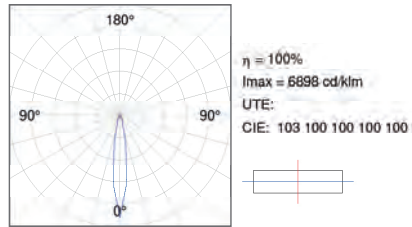

FL 22°-26°

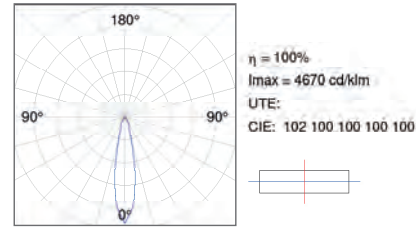

MFL 33°-36°

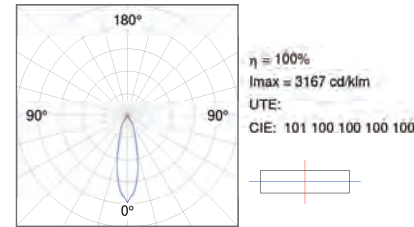

WFL 56°-57°

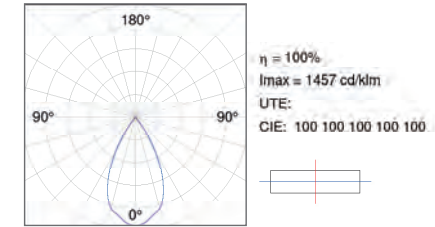

Flujo de salida y potencia

IMAG G3 TRACK

	K	CRI	2000lm		3000lm		4000lm	
			W	lm Output	W	lm Output	W	lm Output
SP 15°-20°	3000	90	16	1416	28,8	2303	42,3	3008
	4000	90	16	1509	28,8	2454	42,3	3205
FL 22°-26°	3000	90	16	1505	28,8	2449	42,3	3198
	4000	90	16	1604	28,8	2609	42,3	3408
MFL 33°-36°	3000	90	16	1469	28,8	2389	42,3	3121
	4000	90	16	1565	28,8	2546	42,3	3325
WFL 56°-57°	3000	90	16	1607	28,8	2615	42,3	3415
	4000	90	16	1712	28,8	2786	42,3	3639



ACCESORIOS

Adaptador obligatorio para utilizar accesorios

	Ref.	Color
	ADRD170B	●

Refractor para distribución elíptica del flujo luminoso

	Ref.	Ømm
	ELRD150	95

Rejilla antideslumbrante tipo panel

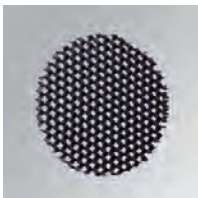
	Ref.	Color
	HORD150	●

Visera antideslumbrante

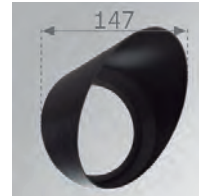
	Ref.	Color
	SCRD170B	●

Aletas antideslumbrantes

	Ref.	Color	mm
	LORD170B	●	L 112

Buffer

	Ref.	Color
	CURD95B	●



Kombic Downlight



BASIC Kombic Downlight 70 Round Opal (54°)



COMFORT Kombic Downlight 70 Round Optic (50°)



EFFICIENCY Kombic Downlight 70 Round Refl ctor

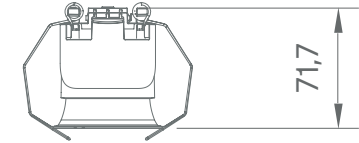
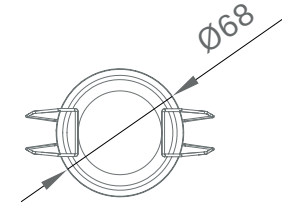

KOMBIC DOWNLIGHT 70 OPAL

Familia	Lm LED	IP	Óptica	IRC	K	Equipo	Acabados Refl ctres	Acabados Ext.
K71	15 1500lm	44 IP 44	OP Opal 54°	9 90 8 80	27 2700 K 30 3000 K 40 4000 K	N ON/OFF D DALI	W White	W White 02
K71	15	44	OP	9	30	N	W	W

KOMBIC DOWNLIGHT 70 OPTIC

Familia	Lm LED	IP	Óptica	IRC	K	Equipo	Acabados Refl ctres	Acabados Ext.
K71	15 1500lm	23 IP 23	WF Optic 52° EL Elliptic	9 90 8 80	27 2700 K 30 3000 K 40 4000 K	N ON/OFF D DALI	W White B Black	W White 02 B Black 02
K71	15	23	WF	9	30	N	W	W

KOMBIC DOWNLIGHT 70 REFLECTOR

Familia	Lm LED	IP	Óptica	IRC	K	Equipo	Acabados Refl ctres	Acabados Ext.
K71	15 1500lm	23 IP 23	RF Flood 33° RW Wide Flood 52°	9 90 8 80	27 2700 K 30 3000 K 40 4000 K	N ON/OFF D DALI	W White B Black	W White 02 B Black 02
K71	15	23	WF	9	30	N	W	W





PRESENTACIÓN FAMILIA

Ind.



BASIC
Kombic Downlight 70
 Round Opal IP65 (54°)



KOMBIC DOWNLIGHT 70 OPAL

Familia	Lm LED	IP	Óptica	IRC	K	Equipo	Acabados Refl ctres	Acabados Ext.
K71	15 1500lm	65 IP 65	OP Opal 54°	9 90 8 80	27 2700 K 30 3000 K 40 4000 K	N ON/OFF D DALI	W White	W White 02
K71	15	65	OP	9	30	N	W	W





OP 54°

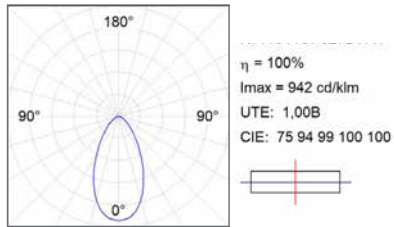

WFL 52°

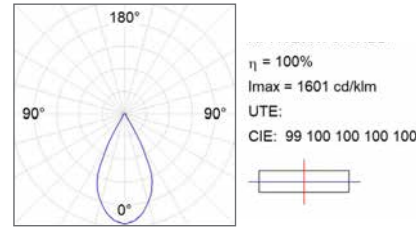

ELLIPTIC

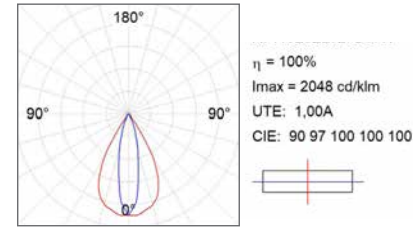

WALL WASHER (WW)

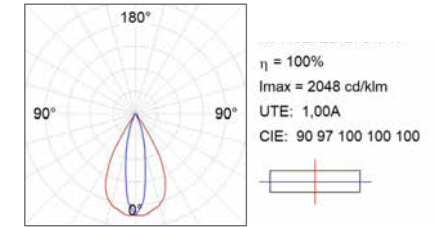

KOMBIC DOWNLIGHT 70 OPAL

	1500lm			
	K	CRI	W	lm Output
WH (54°)	2700	90	9,5	763
		80	9,5	892
	3000	90	9,5	916
		80	9,5	935
	4000	90	9,5	849
		80	9,5	981

KOMBIC DOWNLIGHT 70 WF

	1500lm			
	K	CRI	W	lm Output
WH	2700	90	10	695
		80	10	821
	3000	90	10	732
		80	10	855
	4000	90	10	772
		80	10	905
BK	2700	90	10	515
		80	10	515
	3000	90	10	543
		80	10	543
	4000	90	10	572
		80	10	572

KOMBIC DOWNLIGHT 70 ELLIPTIC

	1500lm			
	K	CRI	W	lm Output
WH	2700	90	9,5	723
		80	9,5	847
	3000	90	9,5	756
		80	9,5	888
	4000	90	9,5	806
		80	9,5	932
BK	2700	90	9,5	657
		80	9,5	768
	3000	90	9,5	686
		80	9,5	805
	4000	90	9,5	731
		80	9,5	845

KOMBIC DOWNLIGHT 70 WALL WASHER

	1500lm			
	K	CRI	W	lm Output
WH	2700	90	9,5	847
		80	9,5	723
	3000	90	9,5	888
		80	9,5	756
	4000	90	9,5	932
		80	9,5	806
BK	2700	90	9,5	768
		80	9,5	657
	3000	90	9,5	805
		80	9,5	686
	4000	90	9,5	845
		80	9,5	731



FL 33°

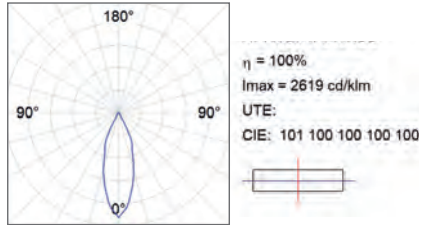

WFL 52°

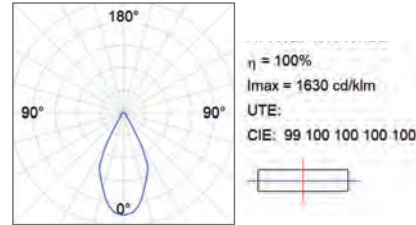

KOMBIC DOWNLIGHT 70 REFLECTOR

		1500lm			
		K	CRI	W	lm Output
FL (33°)	WH	2700	90	9,5	959
			80	9,5	1120
	3000	90	9,5	1000	
		80	9,5	1174	
	4000	90	9,5	1066	
		80	9,5	1232	
BK	2700	90	9,5	840	
		80	9,5	981	
	3000	90	9,5	876	
		80	9,5	1029	
	4000	90	9,5	934	
		80	9,5	1080	

		1500lm			
		K	CRI	W	lm Output
WFL (52°)	WH	2700	90	9,5	901
			80	9,5	1053
	3000	90	9,5	940	
		80	9,5	1104	
	4000	90	9,5	1002	
		80	9,5	1158	
BK	2700	90	9,5	730	
		80	9,5	854	
	3000	90	9,5	762	
		80	9,5	895	
	4000	90	9,5	813	
		80	9,5	939	

Kombic Downlight | Indoor

BASIC Kombic Downlight 100 Round Opal

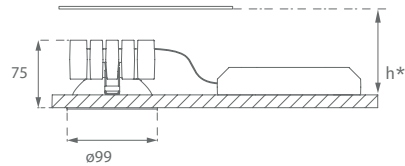

* Consultar altura (h) en hoja instrucciones

BASIC Kombic Downlight 100 Square Opal

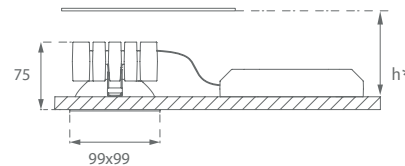

* Consultar altura (h) en hoja instrucciones

BASIC Kombic Downlight 100 Opal IP65

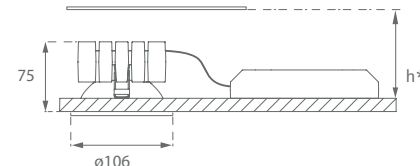

* Consultar altura (h) en hoja instrucciones

KOMBIC DOWNLIGHT 100 OPAL

Familia	Instalación	Lm LED	IP	Óptica	IRC	K	Equipo	Acabados Refl ctiores	Acabados Ext.
K11	RD Round	15 1500lm	40 IP 43	OP Opal	9 90	27 2700 K	N ON/OFF	R Bright	W White 02
		20 2000lm							
	SQ Square	20 2000lm	40 IP 43	OP Opal	8 80	30 3000 K	D DALI	M Metalized Matt	W White
		25 2500lm							
	RD Round	20 2000lm	65 IP 65	OP Opal	8 80	30 3000 K	N ON/OFF	W White	W White 02
		25 2500lm							
K11	RD	15	40	OP	9	30	N	R	W



Kombic Downlight | Indoor

BASIC Kombic Downlight 100 Round Opal

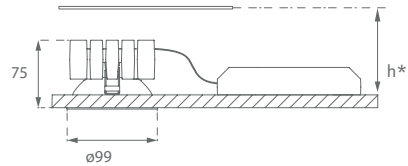

BASIC Kombic Downlight 100 Square Opal

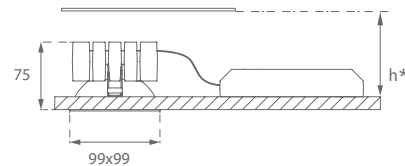

* Consultar altura (h) en hoja instrucciones



PRESENTACIÓN FAMILIA

Ind.



WB

KOMBIC DOWNLIGHT 100 OPAL WELLBEING

Familia	Instalación	Lm LED	IP	Óptica	K	Equipo	Acabados Refl ctiores	Acabados Ext.
K11	RD Round SQ Square	15 1500lm 20 2000lm	40 IP 43	OP Opal	WB3 3000 WB WB4 4000 WB	N ON/OFF D DALI	R Bright M Metalized Matt W White	W White 02
K11	RD	15	40	OP	WB3	N	R	W

KOMBIC DOWNLIGHT 100 OPAL TW

Familia	Instalación	Lm LED	IP	Óptica	IRC	K	Equipo	Acabados Refl ctiores	Acabados Ext.
K11	RD Round SQ Square	20 2000lm	40 IP 43	OP Opal	9 90	TW Tunnable White	D DALI	R Bright M Metalized Matt W White	W White 02
K11	RD	20	40	OP	9	TW	D	R	W



Kombic Downlight | Indoor

COMFORT Kombic Downlight 100 Round Optic

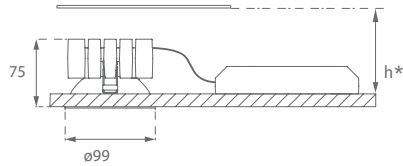

* Consultar altura (h) en hoja instrucciones

COMFORT Kombic Downlight 100 Square Optic

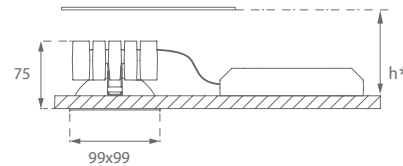

* Consultar altura (h) en hoja instrucciones



PRESENTACIÓN FAMILIA

Ind.



KOMBIC DOWNLIGHT 100 OPTIC

Familia	Instalación	Lm LED	IP	Óptica	IRC	K	Equipo	Acabados Refl ctiores	Acabados Ext.
K11	RD Round SQ Square	15 1500lm	40 IP 43	WF WFL 50°	9 90	27 2700 K 30 3000 K 40 4000 K	N ON/OFF D DALI	B Black M Metalized Matt W White	B Black 02 W White 02
				43 IP 43 WW Wallwasher EL Elliptic					
	20 2000lm	40 IP 43	WF WFL 50°	8 80 9 90					
			43 IP 43 WW Wallwasher EL Elliptic						
	25 2500lm	40 IP 43	WF WFL 50°	8 80					
			43 IP 43 WW Wallwasher EL Elliptic						

K11 RD 15 40 WF 9 27 N B B



Kombic Downlight | Indoor

COMFORT Kombic Downlight 100 Round Optic

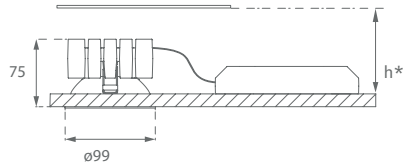

COMFORT Kombic Downlight 100 Square Optic

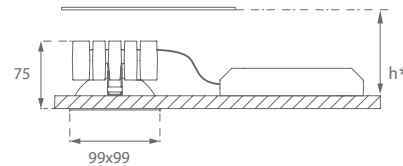

* Consultar altura (h) en hoja instrucciones



PRESENTACIÓN FAMILIA

Ind.



WB

KOMBIC DOWNLIGHT 100 OPTIC WELLBEING

Familia	Instalación	Lm LED	IP	Óptica	K	Equipo	Acabados Refl ctores	Acabados Ext.
K11	RD Round	15 1500lm	40 IP 43	WF WFL 50°	WB3 3000 WB WB4 4000 WB	N ON/OFF D DALI	B Black M Metalized Matt W White	B Black 02 W White 02
	SQ Square	20 2000lm						
K11	RD	15	40	WF	WB3	N	B	W

KOMBIC DOWNLIGHT 100 OPTIC TW

Familia	Instalación	Lm LED	IP	Óptica	IRC	K	Equipo	Acabados Refl ctores	Acabados Ext.
K11	RD Round	20 2000lm	40 IP 43	WF WFL 50°	9 90	TW Tunable White	D DALI	B Black M Metalized Matt W White	B Black 02 W White 02
	SQ Square								
			43 IP 43	WW Wallwasher					
K11	RD	20	40	WF	9	TW	D	B	B



Kombic Downlight | Indoor

EFFICIENCY

Kombic Downlight 100

Refl ctor

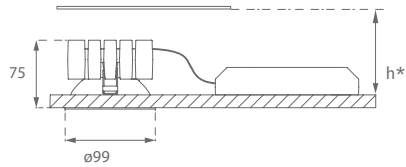

* Consultar altura (h) en hoja instrucciones



PRESENTACIÓN FAMILIA

Ind.



KOMBIC DOWNLIGHT 100 REFLECTOR

Familia	Instalación	Lm LED	IP	Óptica	IRC	K	Equipo	Acabados Refl ctos	Acabados Ext.
K11	RD Round	15 1500lm	23 IP 23	RF Flood	9 90	27 2700 K	N ON/OFF D DALI	B Black M Metalized Matt W White	B Black 02 W White 02
		20 2000lm		RW Wide Flood		30 3000 K 40 4000 K			
		20 2000lm	23 IP 23	RF Flood	8 80	30 3000 K			
		25 2500lm		RW Wide Flood		40 4000 K			
K11	RD	15	23	RF	9	27	N	B	B



CARACTERÍSTICAS TÉCNICAS

Ópticas

OP

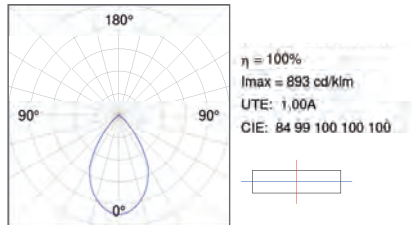

Flujo de salida y potencia

KOMBIC DOWNLIGHT 100 OPAL

	K	CRI	1500lm		2000lm		2500lm	
			W	lm Output	W	lm Output	W	lm Output
BK	2700	90	13,7	1191	-	1598	-	-
		80	13,7	-	-	-	-	-
	3000	90	13,7	1230	20,4	1648	-	-
		80	13,7	-	14,8	1460	21,6	1951
	4000	90	13,7	1336	-	1793	-	-
		80	13,7	-	14,8	1547	21,6	2067
MA	2700	90	13,7	1135	-	1523	-	-
		80	13,7	-	-	-	-	-
	3000	90	13,7	1172	-	1571	-	-
		80	13,7	-	14,8	1392	21,6	1951
	4000	80	13,7	1273	19,1	1708	-	-
		90	13,7	-	14,8	1474	21,6	2067
WH	2700	90	13,7	1186	19,1	1591	-	-
		80	13,7	-	-	-	-	-
	3000	90	13,7	1125	19,1	1642	-	-
		80	13,7	-	14,8	1454	21,6	1951
	4000	90	13,7	1330	19,1	1785	-	-
		80	13,7	-	14,8	1541	21,6	2067

KOMBIC DOWNLIGHT 100 OPAL WELLBEING

	K	CRI	1200lm		1800lm	
			W	lm Output	W	lm Output
MA	3000	95	13,9	929	20	1243
		4000	95	13,9	986	20
BR	3000	95	13,9	971	20	1316
		4000	95	13,9	1031	20
WH	3000	95	13,9	951	20	1206
		4000	95	13,9	1035	20



CARACTERÍSTICAS TÉCNICAS

Flujo de salida y potencia

WFL 50°

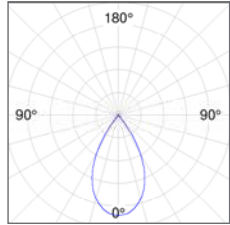

$\eta = 100\%$
 $l_{max} = 1327 \text{ cd/klm}$
 UTE:
 CIE: 99 100 100 100 100



KOMBIC DOWNLIGHT 100 OPTIC WIDE FLOOD (WF)

	K	CRI	1500lm		2000lm		2500lm	
			W	lm Output	W	lm Output	W	lm Output
BK	2700	90	13,4	983	-	-	-	-
		80	-	-	-	-	21,6	1609
	3000	90	13,4	1015	20,4	1354	-	-
		80	-	-	14,8	1205	21,6	1609
4000	90	13,4	1102	-	-	-	-	
	80	-	-	14,8	1277	21,6	1704	
MA	2700	90	13,4	1030	19,1	1380	-	-
		80	-	-	-	-	-	-
	3000	90	13,4	1068	19,1	1424	-	-
		80	-	-	13,7	1268	19,8	1692
4000	90	13,4	1160	19,1	1548	-	-	
	80	-	-	13,7	1343	19,8	1792	
WH	2700	90	13,4	1040	19,1	1387	-	-
		80	-	-	-	-	-	-
	3000	90	13,4	1074	19,1	1432	-	-
		80	-	-	13,7	1275	19,8	1701
4000	90	13,4	1166	19,1	1556	-	-	
	80	-	-	13,7	1351	19,8	1802	

KOMBIC DOWNLIGHT 100 OPTIC WALL WASHER (WW)

	K	CRI	1500lm		2000lm		2500lm	
			W	lm Output	W	lm Output	W	lm Output
BK	2700	90	13,7	901	19,8	1209	-	-
		80	-	-	-	-	-	-
	3000	90	13,7	940	19,8	1262	-	-
		80	13,7	1159	13,7	1159	19,8	1555
4000	90	13,7	1003	19,8	1346	-	-	
	80	13,7	1216	13,7	1216	19,8	1632	
MA	2700	90	13,7	1210	19,8	1633	-	-
		80	-	-	-	-	-	-
	3000	90	13,7	1263	19,8	1703	-	-
		80	13,7	1556	13,7	1556	19,8	2099
4000	90	13,7	1346	19,8	1816	-	-	
	80	13,7	1633	13,7	1633	19,8	2203	
WH	2700	90	13,7	1210	19,8	1633	-	-
		80	-	-	-	-	-	-
	3000	90	13,7	1263	19,8	1703	-	-
		80	13,7	1556	13,7	1556	19,8	2099
4000	90	13,7	1346	19,8	1816	-	-	
	80	13,7	1633	13,7	1633	19,8	2203	

KOMBIC DOWNLIGHT 100 OPTIC WELLBEING WIDE FLOOD (WF)

	K	CRI	1200lm		1800lm	
			W	lm Output	W	lm Output
BK	3000	95	13,9	835	20	1109
		4000	95	13,9	885	20
MA	3000	95	13,9	862	20	1185
		4000	95	13,9	914	20
WH	3000	95	13,9	857	20	1057
		4000	95	13,9	947	20



CARACTERÍSTICAS TÉCNICAS

Flujo de salida y potencia

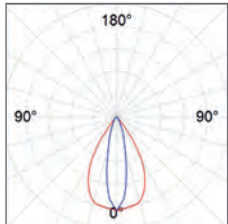

$\eta = 101\%$
 $I_{max} = 1940 \text{ cd/klm}$
 UTE: 1,01A
 CIE: 92 99 100 100 101



KOMBIC DOWNLIGHT 100 OPTIC ELLIPTIC

	K	CRI	1500lm		2000lm	
			W	lm Output	W	lm Output
BK	2700	90	13,7	1163	19,8	1563
		80	13,7	-	19,8	-
	3000	90	13,7	1213	19,8	1631
		80	13,7	1425	19,8	1915
	4000	90	13,7	1294	19,8	1739
		80	13,7	1495	19,8	2010
MA	2700	90	13,7	1239	19,8	1665
		80	13,7	-	19,8	-
	3000	90	13,7	1293	19,8	1737
		80	13,7	1518	19,8	2040
	4000	90	13,7	1378	19,8	1853
		80	13,7	1593	19,8	2141
WH	2700	90	13,7	1239	19,8	1665
		80	13,7	-	19,8	-
	3000	90	13,7	1293	19,8	1737
		80	13,7	1518	19,8	2040
	4000	90	13,7	1378	19,8	1853
		80	13,7	1593	19,8	2141



CARACTERÍSTICAS TÉCNICAS

Flujo de salida y potencia

KOMBIC DOWNLIGHT 100 REFLECTOR WF

				1500lm		2000lm		2500lm	
		K	CRI	W	lm Output	W	lm Output	W	lm Output
WF	BK	2700	90	14,5	1168	19,8	1711	-	-
			80	-	-	-	-	-	-
		3000	90	14,5	1218	19,8	1785	-	-
			80	-	-	14,5	1549	19,8	1908
		4000	90	14,5	1299	19,8	1903	-	-
			80	-	-	14,5	1226	19,8	2002
MA	2700	90	14,5	1264	19,8	1815	-	-	
			80	-	-	-	-	-	-
		3000	90	14,5	1318	19,8	1893	-	-
			80	-	-	14,5	1538	19,8	2081
		4000	90	14,5	1406	19,8	2019	-	-
			80	-	-	14,5	1692	19,8	2184
WH	2700	90	14,5	1264	19,8	1815	-	-	
			80	-	-	-	-	-	-
		3000	90	14,5	1318	19,8	1893	-	-
			80	-	-	14,5	1612	19,8	2081
		4000	90	14,5	1406	19,8	2019	-	-
			80	-	-	14,5	1692	19,8	2184

KOMBIC DOWNLIGHT 100 REFLECTOR FL

				1500lm		2000lm		2500lm	
		K	CRI	W	lm Output	W	lm Output	W	lm Output
FL	BK	2700	90	14,5	1273	21,6	1711	-	-
			80	-	-	-	-	-	-
		3000	90	14,5	1328	21,6	1785	-	-
			80	-	-	14,1	1549	19,8	2082
		4000	90	14,5	1416	21,6	1903	-	-
			80	-	-	14,1	1226	19,8	2185
MA	2700	90	14,5	1325	21,6	1815	-	-	
			80	-	-	-	-	-	-
		3000	90	14,5	1382	21,6	1893	-	-
			80	-	-	14,1	1612	19,8	2208
		4000	90	14,5	1474	21,6	2019	-	-
			80	-	-	14,1	1692	19,8	2318
WH	2700	90	14,5	1325	21,6	1815	-	-	
			80	-	-	-	-	-	-
		3000	90	14,5	1382	21,6	1893	-	-
			80	-	-	14,1	1612	19,8	2208
		4000	90	14,5	1474	21,6	2019	-	-
			80	-	-	14,1	1692	19,8	2318

Kombic Downlight | Indoor

BASIC Kombic Downlight 150 Opal

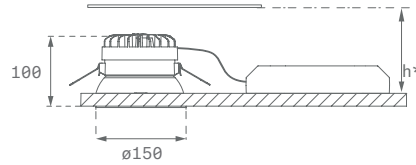

* Consultar altura (h) en hoja instrucciones

BASIC Kombic Downlight 150 Opal IP65

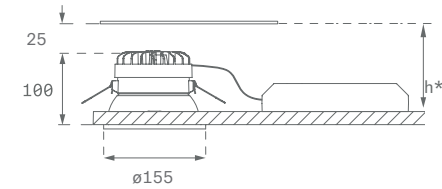

* Consultar altura (h) en hoja instrucciones

KOMBIC DOWNLIGHT 150 OPAL

Familia	Instalación	Lm LED	IP	Óptica	IRC	K	Equipo	Acabados Refl. colores	Acabados Ext.
K21	RD Round	20 2000lm	40 IP 43	OP Opal	9 90	27 2700 K	N ON/OFF D DALI	R Bright M Metalized Matt W White	W White 02
		30 3000lm							
		40 4000 K							
	RD Round	20 2000lm	65 IP 65	OP Opal	8 80	30 3000 K	N ON/OFF D DALI	W White	W White 02
		30 3000lm							
		35 3500lm							
20 2000lm	40	OP	9	27	N	R	W		

Kombic Downlight | Indoor

BASIC Kombic Downlight 150 Opal

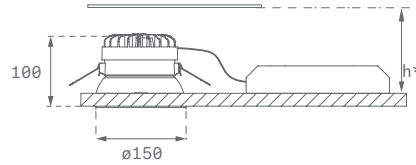

* Consultar altura (h) en hoja instrucciones



PRESENTACIÓN FAMILIA

Ind.



WB

KOMBIC DOWNLIGHT 150 OPAL WELLBEING

Familia	Instalación	Lm LED	IP	Óptica	K	Equipo	Acabados Refl ctiores	Acabados Ext.
K21	RD Round	20 2000lm 25 2500lm	40 IP 43	OP Opal	WB3 3000 WB WB4 4000 WB	N ON/OFF D DALI	R Bright M Metalized Matt W White	W White 02
K21	RD	20	40	OP	WB3	N	R	W

KOMBIC DOWNLIGHT 150 OPAL TW

Familia	Instalación	Lm LED	IP	Óptica	IRC	K	Equipo	Acabados Refl ctiores	Acabados Ext.
K21	RD Round	30 3000lm	40 IP 43	OP Opal	9 90	TW Tunnable White	D DALI	R Bright M Metalized Matt W White	W White 02
K21	RD	30	40	OP	9	TW	D	R	W



Kombic Downlight | Indoor

COMFORT Kombic Downlight 150 Optic

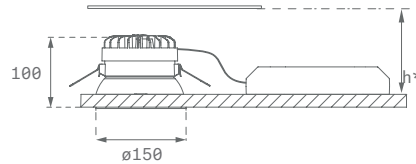

* Consultar altura (h) en hoja instrucciones



PRESENTACIÓN FAMILIA

Ind.



KOMBIC DOWNLIGHT 150 OPTIC

Familia	Instalación	Lm LED	IP	Óptica	IRC	K	Equipo	Acabados Refl ctres	Acabados Ext.
K21	RD Round	20 2400lm	40 IP 43	WF WFL 50°	9 90	27 2700 K	N ON/OFF D DALI	B Black	B Black 02 W White 02
		30 3400lm		WW WallWasher		30 3000 K			
				EL Elliptic		40 4000 K			
		20 2000lm	40 IP 43	WF WFL 50°	8 80	30 3000 K		M Metalized Matt W White	W White 02
		30 2800lm		WW WallWasher		40 4000 K			
		35 3700lm		EL Elliptic					
K21	RD	20	40	WF	9	27	N	B	B

KOMBIC DOWNLIGHT 150 OPTIC WELLBEING WB

Familia	Instalación	Lm LED	IP	Óptica	K	Equipo	Acabados Refl ctres	Acabados Ext.
K21	RD Round	20 2000lm	40 IP 43	WF WFL 50°	WB3 3000 WB	N ON/OFF D DALI	B Black	B Black W White 02
		25 2500lm			WB4 4000 WB			
K21	RD	20	40	WF	WB3	N	B	B

KOMBIC DOWNLIGHT 150 OPTIC TW

Familia	Instalación	Lm LED	IP	Óptica	IRC	K	Equipo	Acabados Refl ctres	Acabados Ext.
K21	RD Round	30 3000lm	40 IP 43	WF WFL 50°	9 90	TW Tunnable White	D DALI	B Black	B Black W White 02
									M Metalized Matt W White
K21	RD	30	40	WF	9	TW	D	B	B



Kombic Downlight | Indoor

EFFICIENCY

Kombic Downlight 150

Round Reflector

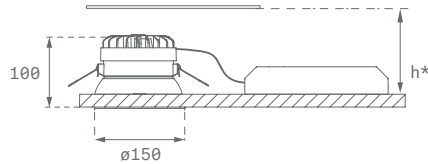

* Consultar altura (h) en hoja instrucciones



PRESENTACIÓN FAMILIA

Ind.



KOMBIC DOWNLIGHT 150 REFLECTOR

Familia	Instalación	Lm LED	IP	Óptica	IRC	K	Equipo	Acabados Refl. ctores	Acabados Ext.
K21	RD Round	20 2000lm 30 3000lm	23 IP 23	RF Flood	9 90	27 2700 K	N ON/OFF D DALI	B Black	B Black 02
				RW Wide Flood		30 3000 K			W White 02
		20 2000lm 30 3000lm 35 3500lm	23 IP 23	RF Flood	8 80	30 3000 K	M Metalized Matt W White	W White 02	
				RW Wide Flood		40 4000 K			
						40 4000 K			
K21	RD	20	23	RF	9	27	N	B	B



CARACTERÍSTICAS TÉCNICAS

Ópticas

OP

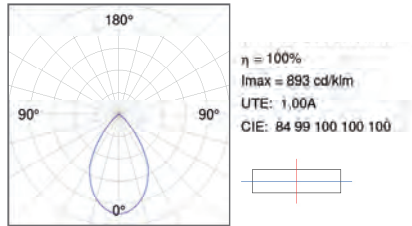

WFL 50°

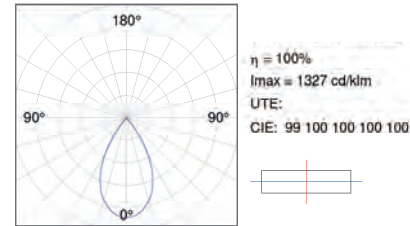

Flujo de salida y potencia

KOMBIC DOWNLIGHT 150 OPAL

	K	CRI	2000lm		3000lm		3500lm	
			W	lm Output	W	lm Output	W	lm Output
BR	2700	90	19,8	1675	27,7	2227	-	-
		80	-	-	-	-	-	-
	3000	90	19,8	1739	27,7	2312	-	-
		80	13,4	1488	19,9	2096	27,7	2788
MA	2700	90	19,8	1874	27,7	2492	-	-
		80	13,4	1550	19,9	2184	27,7	2904
	3000	90	19,8	1667	27,7	2216	-	-
		80	13,4	1427	19,9	2010	27,7	2673
WH	2700	90	19,8	1658	27,7	2203	-	-
		80	-	-	-	-	-	-
	3000	90	19,8	1720	27,7	2288	-	-
		80	13,4	1473	19,9	2074	27,7	2759
4000	90	19,8	1854	27,7	2466	-	-	
	80	13,4	1534	19,9	2161	27,7	2874	

KOMBIC DOWNLIGHT 150 OPTIC WIDE FLOOD

	K	CRI	2000lm		3000lm		3500lm	
			W	lm Output	W	lm Output	W	lm Output
BK	2700	90	19,8	1289	27,7	1713	-	-
		80	-	-	-	-	-	-
	3000	90	19,8	1338	27,7	1779	-	-
		80	13,4	1145	19,9	1613	27,7	2145
MA	2700	90	19,8	1442	27,7	1917	-	-
		80	13,4	1193	19,9	1680	27,7	2235
	3000	90	19,8	1342	27,7	1784	-	-
		80	13,4	1148	19,9	1618	27,7	2151
WH	2700	90	19,8	1446	27,7	1923	-	-
		80	13,4	1196	19,9	1685	27,7	2241
	3000	90	19,8	1332	27,7	1771	-	-
		80	-	-	-	-	-	
4000	90	19,8	1383	27,7	1838	-	-	
	80	13,4	1184	19,9	1677	27,7	2217	
4000	90	19,8	1490	27,7	1982	-	-	
	80	13,4	1233	19,9	1737	27,7	2310	



CARACTERÍSTICAS TÉCNICAS

Flujo de salida y potencia

KOMBIC DOWNLIGHT 150 OPAL WELLBEING

	K	CRI	2000lm		2500lm	
			W	lm Output	W	lm Output
BK	3000	95	19	1368	27,4	1932
	4000	95	19	1491	27,4	2190
MA	3000	95	19	1308	27,4	1884
	4000	95	19	1429	27,4	2075
WH	3000	95	19	1361	27,4	1951
	4000	95	19	1474	27,4	2170

KOMBIC DOWNLIGHT 150 OPTIC WELLBEING WIDE FLOOD

	K	CRI	2000lm		2500lm	
			W	lm Output	W	lm Output
BK	3000	95	19	1192	27,4	1543
	4000	95	19	1297	27,4	1652
MA	3000	95	19	1205	27,4	1567
	4000	95	19	1321	27,4	1713
WH	3000	95	19	1208	27,4	1596
	4000	95	19	1335	27,4	1711

KOMBIC DOWNLIGHT 150 OPTIC ELLIPTIC

	K	CRI	2000lm		3000lm		3500lm	
			W	lm Output	W	lm Output	W	lm Output
BR	2700	90	19,4	1725	27,7	2275	-	-
			80	-	-	-	-	-
	3000	90	19,4	1815	27,7	2395	-	-
80			13,4	1555	19,4	2125	27,7	2805
4000	90	19,4	1915	27,7	2525	-	-	
		80	13,4	1645	19,9	2250	27,7	2965
WH	2700	90	19,4	1815	27,7	2395	-	-
			80	-	-	-	-	-
	3000	90	19,4	1910	27,7	2520	-	-
80			13,4	1640	19,4	2240	27,7	2955
4000	90	19,4	2020	27,7	2670	-	-	
		80	13,4	1730	19,4	2370	27,7	3125

KOMBIC DOWNLIGHT 150 OPTIC WALLWASHER

	K	CRI	2000lm		3000lm		3500lm	
			W	lm Output	W	lm Output	W	lm Output
BK	2700	90	19,4	1195	27,7	1575	-	-
			80	-	-	-	-	-
	3000	90	19,4	1260	27,7	1660	-	-
80			13,4	1080	19,4	1475	27,7	1945
4000	90	19,4	1330	27,7	1750	-	-	
		80	13,4	1140	19,9	1560	27,7	2055
WH	2700	90	19,4	1470	27,7	1940	-	-
			80	-	-	-	-	-
	3000	90	19,4	1550	27,7	2040	-	-
80			13,4	1330	19,4	1815	27,7	2395
4000	90	19,4	1635	27,7	2155	-	-	
		80	13,4	1405	19,4	1920	27,7	2530



CARACTERÍSTICAS TÉCNICAS

Flujo de salida y potencia

FL 30°

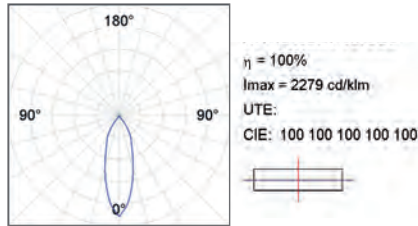

WFL 55°

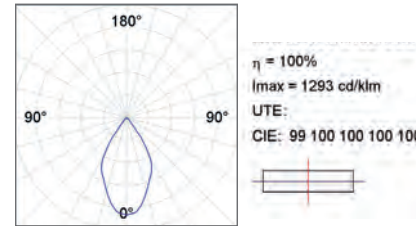

KOMBIC DOWNLIGHT 150 REFLECTOR FLOOD (30°)

	K	CRI	20001m		30001m		35001m	
			W	lm Output	W	lm Output	W	lm Output
BK	2700	90	19,1	1992	28,3	2622	-	-
		80	13,9	-	19,1	-	-	-
	3000	90	19,1	2089	28,3	2749	-	-
		80	13,9	1835	19,1	2448	28,3	3223
	4000	90	19,1	2225	28,3	2929	-	-
		80	13,1	1927	19,1	2570	28,3	3383
MA	2700	90	19,1	1945	28,3	2560	-	-
		80	13,9	-	19,1	-	-	-
	3000	90	19,1	2039	28,3	2684	-	-
		80	13,9	1792	19,1	2390	28,3	3146
	4000	90	19,1	2172	28,3	2962	-	-
		80	13,1	1881	19,1	2509	28,3	3303
WH	2700	90	19,1	1945	28,3	2560	-	-
		80	13,9	-	19,1	-	-	-
	3000	90	19,1	2039	28,3	2684	-	-
		80	13,9	1792	19,1	2390	28,3	3146
	4000	90	19,1	2172	28,3	2860	-	-
		80	13,1	1881	19,1	2509	28,3	3303

KOMBIC DOWNLIGHT 150 REFLECTOR WIDE FLOOD (55°)

	K	CRI	15001m		20001m		25001m	
			W	lm Output	W	lm Output	W	lm Output
BK	2700	90	19,1	2002	28,3	2635	-	-
		80	-	-	-	-	-	-
	3000	90	19,1	2099	28,3	2763	-	-
		80	13,9	1844	19,1	2460	28,3	3239
	4000	90	19,1	2236	28,3	2944	-	-
		80	13,1	1936	19,1	2583	28,3	3400
MA	2700	90	19,1	2014	28,3	2651	-	-
		80	-	-	-	-	-	-
	3000	90	19,1	2112	28,3	2780	-	-
		80	13,9	1854	19,1	2475	28,3	3259
	4000	90	19,1	2250	28,3	2962	-	-
		80	13,1	1948	19,1	2598	28,3	3420
WH	2700	90	19,1	2014	28,3	2651	-	-
		80	-	-	-	-	-	-
	3000	90	19,1	2112	28,3	2780	-	-
		80	13,9	1854	19,1	2475	28,3	3259
	4000	90	19,1	2250	28,3	2962	-	-
		80	13,1	1948	19,1	2598	28,3	3420

Kombic Downlight | Indoor

BASIC Kombic Downlight 200 Opal

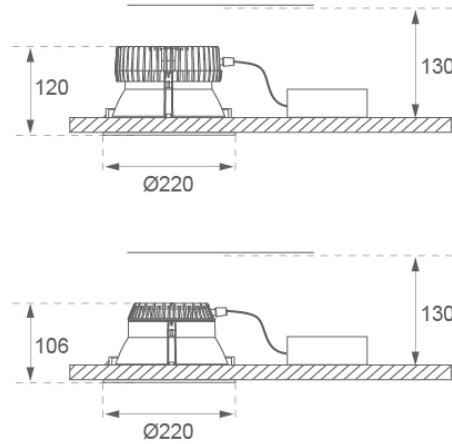

PRESENTACIÓN FAMILIA

Ind.



BASIC Kombic Downlight 200 Square Opal

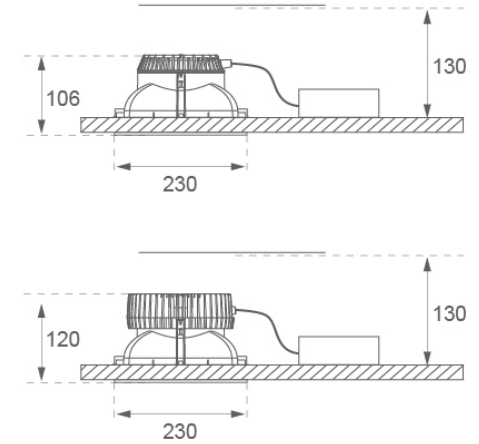

KOMBIC DOWNLIGHT 200 OPAL

Familia	Instalación	Lm LED	IP	Óptica	IRC	K	Equipo	Acabados Refl. colores	Acabados Ext.
K32	RD Round	30 3000lm	40 IP 44	OP Opal	8 80	30 3000 K	N ON/OFF D DALI	R Bright M Matt W White Lexan	W White
		40 4000lm							
		50 5000lm							
		70 7000lm							
	SQ Square	30 3000lm	40 IP 44	OP Opal	8 80	30 3000 K	N ON/OFF D DALI	R Bright W White Lexan	W White
		40 4000lm							
		50 5000lm							
		70 7000lm							
	RD Round	20 2000lm	40 IP 44	OP Opal	9 90	TW Tunable White	D DALI	R Bright M Matt	W White
30 3000lm									
K32	RD	30	40	OP	8	30	N	R	W





CARACTERÍSTICAS TÉCNICAS

Ópticas

RD OPAL BRIGHT

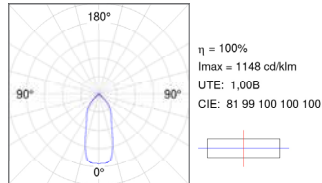

RD OPAL MATT

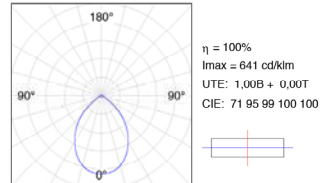

SQ OPAL BRIGHT

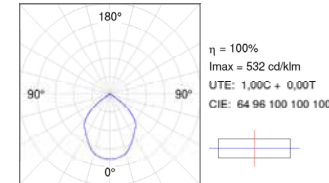

RD WHITE OPAL

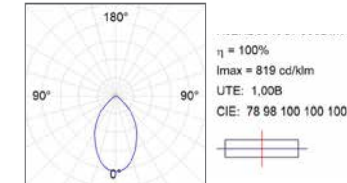

SQ OPAL OPAL

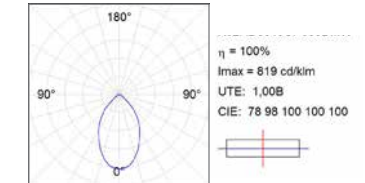

Flujo de salida y potencia

KOMBIC 200 RD

	K	CRI	3000lm		4000lm		5000lm		7000lm	
			W	lm Output	W	lm Output	W	lm Output	W	lm Output
BR	3000	80	16,7	2181	24,1	3025	34	3977	51	5789
	4000	80	16,7	2304	24,1	3195	34	4201	51	5840
MA	3000	80	16,7	2138	24,1	2966	34	3899	51	5373
	4000	80	16,7	2259	24,1	3133	34	4119	51	5676
WH	3000	80	16,7	2138	24,1	2966	34	3899	51	5373
		80	16,7	2318	24,1	3214	34	4226	51	5823

KOMBIC 200 TW

	K	CRI	2000lm		3000lm	
			W	lm Output	W	lm Output
BR	TW	90	15,5	1506	22,4	2161
MA	TW	90	15,5	1355	22,4	1989

KOMBIC 200 SQ

	K	CRI	3000lm		4000lm		5000lm		7000lm	
			W	lm Output	W	lm Output	W	lm Output	W	lm Output
BR	3000	80	16,7	2181	24,1	3025	34	3977	51	5789
	4000	80	16,7	2304	24,1	3195	34	4201	51	5840
MA	3000	80	16,7	2138	24,1	2966	34	3899	51	5373
	4000	80	16,7	2259	24,1	3133	34	4119	51	5676
WH	3000	80	16,7	2138	24,1	2966	34	3899	51	5373
		80	16,7	2318	24,1	3214	34	4226	51	5823



Aro embellecedor



Ref.

RIRD240W
RIRD240G
RIRD240B

Color



Difusor transparente



Ref.

DITRRD240W
DITRRD240G
DITRRD240B

Color



Aro adaptador para ø250 mm



Ref.

ADRD250W

Color



ACCESORIOS SQUARE

Marco embellecedor



Ref.

FRSQ235W
FRSQ235B

Color



Difusor transparente



Ref.

DITRSQ240W
DITRSQ240B

Color



Caja empotramiento para hormigón

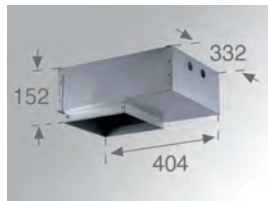

Ref.

BORE404

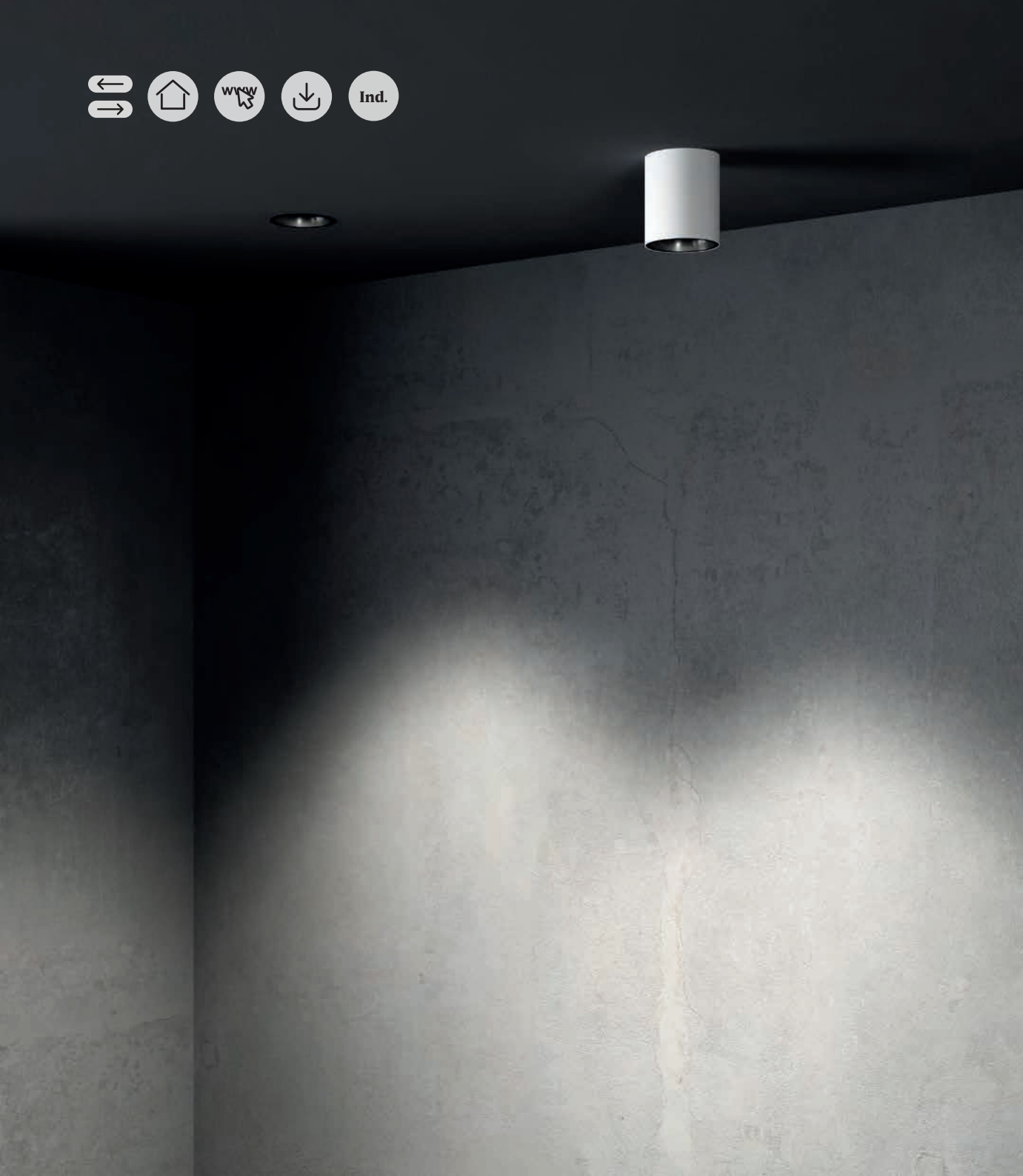

Kombic Surface

Kombic Surface 70
ON/OFF 1500



PRESENTACIÓN FAMILIA

Ind.



Surface



REFLECTOR FLOOD



WIDE FLOOD

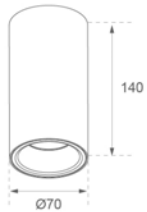

Track

OPAL



REFLECTOR FLOOD



WIDE FLOOD

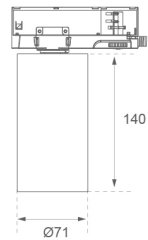

Short Track

OPAL



REFLECTOR FLOOD



WIDE FLOOD

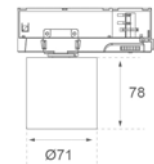

Susp. Track

OPAL



REFLECTOR FLOOD



WIDE FLOOD

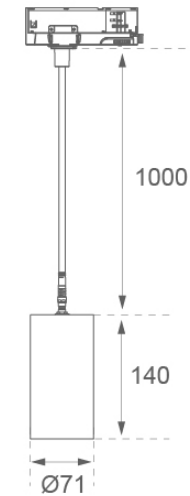

Kombic Surface 70
DALI 1500



PRESENTACIÓN FAMILIA

Ind.



Surface

OPAL



REFLECTOR FLOOD



WIDE FLOOD

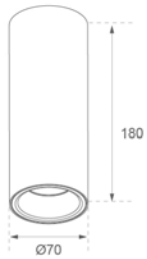

Track

OPAL



REFLECTOR FLOOD



WIDE FLOOD

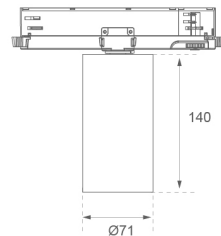

Short Track

OPAL



REFLECTOR FLOOD



WIDE FLOOD

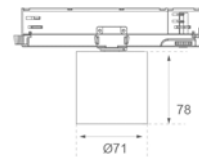

Susp. Track

OPAL



REFLECTOR FLOOD



WIDE FLOOD

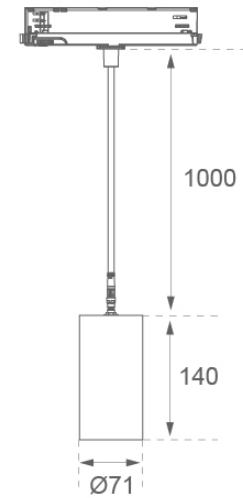



Kombic Surface 70 ON/OFF & DALI 1500

KOMBIC SURFACE 70

Familia	Instalación	Lm LED	IP	Óptica	IRC	K	Equipo	Reflector	Acabados Ext.	
K71	SF Surface	15 1500lm	20 IP 23	RF Reflector Flood	8 80 9 90	27 2700 K	N ON/OFF D DALI	B Black	B Black	
	TK Track			RW Reflector Wide		30 3000 K		W White	W White	
	ST Susp. Track			40 IP 43		OP Opal		27 2700 K	W White	W White
	TS Track Short					9 90		30 3000 K 40 4000 K	D DALI	W White
				WF Wide Flood	8 80 9 90	27 2700 K 30 3000 K 40 4000 K	N ON/OFF D DALI	B Black W White	B Black W White	
K71	SF	15	20	OP	9	27	N	B	B	

ACCESORIOS

Suspensión rígida para conexión eléctrica



Ref.

K71SUCAWI2000DBK
K71SUCAWI2000DWH
K71SUCAWI2000NBK
K71SUCAWI2000NWH

Color

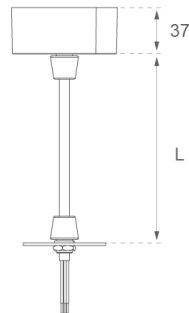

Pasacables



Ref.

K71SUADLATWH
K71SUADLATBK

Color

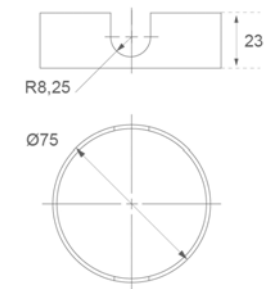



CARACTERÍSTICAS TÉCNICAS

Ópticas

OP

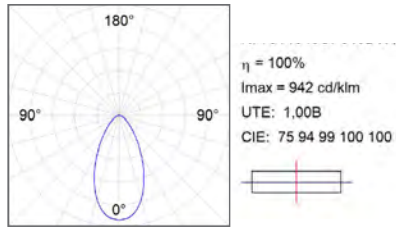

WF

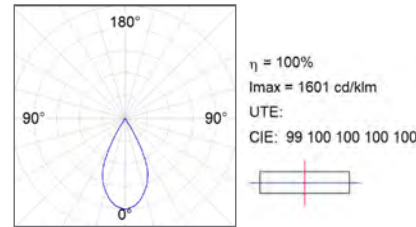

RW

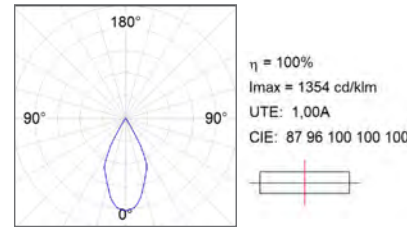

RF

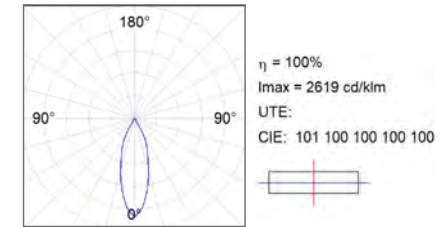

Flujo de salida y potencia

KOMBIC DOWNLIGHT 70 OPAL

		1500lm			
		K	CRI	W	lm Output
WH/ BK	2700	90	9,5	763	
		80	9,5	892	
	3000	90	9,5	916	
		80	9,5	935	
	4000	90	9,5	849	
		80	9,5	981	

KOMBIC DOWNLIGHT 70 OPTIC

		1500lm			
		K	CRI	W	lm Output
WH	2700	90	9,5	975	
		80	9,5	929	
	3000	90	9,5	829	
		80	9,5	973	
BK	4000	90	9,5	884	
		80	9,5	1022	
	2700	90	9,5	708	
		80	9,5	828	
3000	90	9,5	739		
	80	9,5	868		
4000	90	9,5	788		
	80	9,5	911		

KOMBIC DOWNLIGHT 70 REFLECTOR

		1500lm						1500lm			
		K	CRI	W	lm Output			K	CRI	W	lm Output
FL (33°)	WH	2700	90	9,5	959	WFL (52°)	WH	2700	90	9,5	901
			80	9,5	1120				80	9,5	1053
	3000	90	9,5	1000	3000	90	9,5	940			
		80	9,5	1174		80	9,5	1104			
BK	4000	90	9,5	1066	4000	90	9,5	1002			
		80	9,5	1232		80	9,5	1158			
	2700	90	9,5	840	BK	2700	90	9,5	730		
		80	9,5	981			80	9,5	854		
3000	90	9,5	876	3000	90	9,5	762				
	80	9,5	1029		80	9,5	895				
4000	90	9,5	934	4000	90	9,5	813				
	80	9,5	1080		80	9,5	939				





Kombic Surface 100
Opal ON/OFF 1500/2000

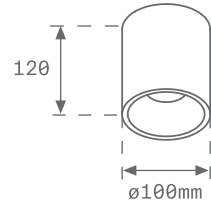

Kombic Surface 100
Opal DALI 1500/2000

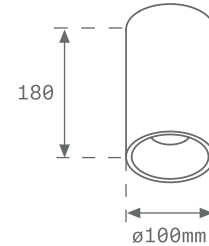

Kombic Surface 100
Opal TW 1500/2000

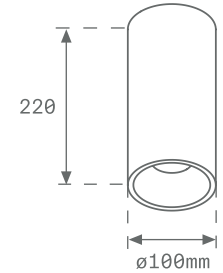

KOMBIC SURFACE 100 OPAL

Familia	Instalación	Lm LED	IP	Óptica	IRC	K	Equipo	Acabados Refl ctores	Acabados Ext.
K11	SF Surface	15 1500lm	40 IP 43	OP Opal	9 90	27 2700 K	N ON/OFF D DALI	R Bright M Metalized Matt W White	W White 02 B Black 02
		20 2000lm							
		20 2000lm	40 IP 43	OP Opal	8 80	30 3000 K			
		25 2500lm							
K11	SF	15	40	OP	9	27	N	R	W

KOMBIC SURFACE 100 OPAL WELLBEING WB

Familia	Instalación	Lm LED	IP	Óptica	K	Equipo	Acabados Refl ctores	Acabados Ext.
K11	SF Surface	15 1500lm	40 IP 43	OP Opal	WB3 3000 WB WB4 4000 WB	N ON/OFF D DALI	R Bright M Metalized Matt W White	W White 02 B Black 02
		20 2000lm						
K11	SF	15	40	OP	WB3	N	R	W

KOMBIC SURFACE 100 OPAL TW

Familia	Instalación	Lm LED	IP	Óptica	IRC	K	Equipo	Acabados Refl ctores	Acabados Ext.
K11	SF Surface	20 2000lm	40 IP 43	OP Opal	9 90	TW Tunable White	D DALI	R Bright M Metalized Matt W White	W White 02 B Black 02
K11	SF	20	40	OP	9	TW	D	R	W





Kombic Surface 100 Track
Opal ON/OFF 1500/2000

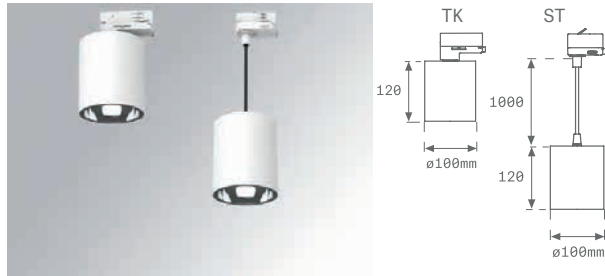

Kombic Surface 100 Track
Opal DALI 1500/2000/2500
Opal ON/OFF 2500

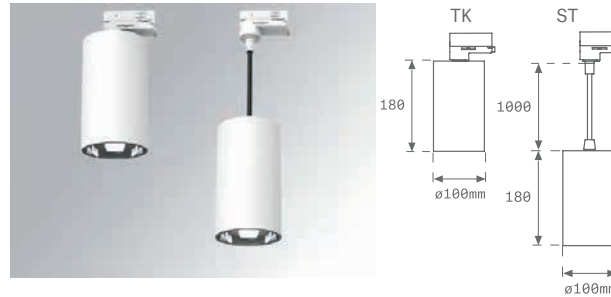

Kombic Surface 100 Track
Opal TW 1500/2000

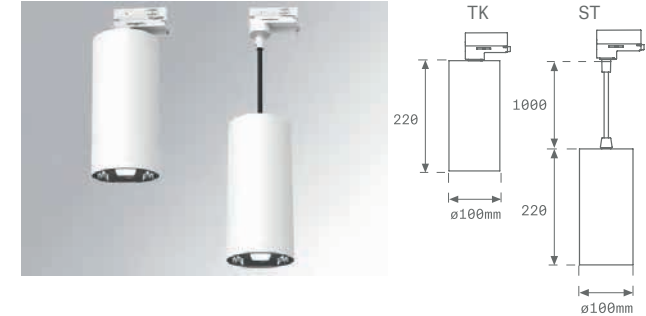

KOMBIC SURFACE 100 TRACK OPAL

Familia	Instalación	Lm LED	IP	Óptica	IRC	K	Equipo	Acabados Refl. colores	Acabados Ext.
K11	TK Track	15 1500lm	40 IP 43	OP Opal	9 90	27 2700 K	N ON/OFF D DALI	R Bright M Metalized Matt W White	W White 02 B Black 02
	ST Sus. Track	20 2000lm				30 3000 K 40 4000 K			
			20 2000lm	40 IP 43	OP Opal	8 80	30 3000 K		
			25 2500lm				40 4000 K		
K11	TK	15	40	OP	9	27	N	R	W

KOMBIC SURFACE 100 TRACK OPAL WELLBEING

Familia	Instalación	Lm LED	IP	Óptica	K	Equipo	Acabados Refl. colores	Acabados Ext.
K11	TK Track	15 1500lm	40 IP 43	OP Opal	WB3 3000 WB	N ON/OFF D DALI	R Bright M Metalized Matt W White	W White 02 B Black 02
	ST Sus. Track	20 2000lm			WB4 4000 WB			
K11	TK	15	40	OP	WB3	N	R	W

KOMBIC SURFACE 100 TRACK OPAL TW

Familia	Instalación	Lm LED	IP	Óptica	IRC	K	Equipo	Acabados Refl. colores	Acabados Ext.
K11	TK Track	20 2000lm	40 IP 43	OP Opal	9 90	TW Tunable White	D DALI	R Bright M Metalized Matt W White	W White 02 B Black 02
	ST Sus. Track								
K11	TK	20	40	OP	9	TW	D	R	W





PRESENTACIÓN FAMILIA

Ind.



Kombic Surface 100
Optic ON/OFF 1500/2000



UGR <19 UGR <17

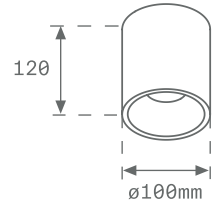

Kombic Surface 100
Optic DALI 1500/2000



UGR <19 UGR <17

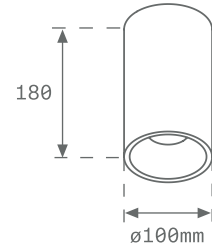

Kombic Surface 100
OpticTW 1500/2000



UGR <19 UGR <17

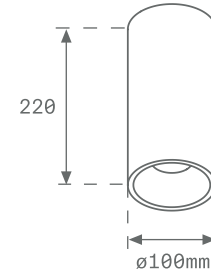

KOMBIC SURFACE 100 OPTIC

Familia	Instalación	Lm LED	IP	Óptica	IRC	K	Equipo	Acabados Refl ctiores	Acabados Ext.			
K11	SF Surface	15 1500lm	40 IP 43	WF Wide Flood 50°	9 90	27 2700 K	N ON/OFF	B Black	W White 02			
		20 2000lm				30 3000 K						
		20 2000lm	40 IP 43	WF Wide Flood 50°	8 80	30 3000 K				D DALI	M Metalized Matt	B Black 02
		25 2500lm				40 4000 K						
K11	SF	15	40	WF	9	27	N	B	W			





PRESENTACIÓN FAMILIA

Ind.



Kombic Surface 100
Optic ON/OFF 1500/2000



UGR <19 UGR <17

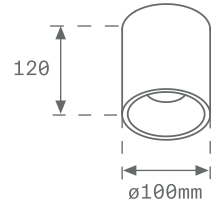

Kombic Surface 100
Optic DALI 1500/2000



UGR <19 UGR <17

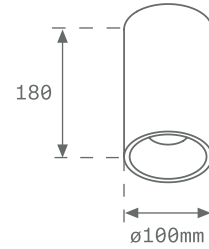

Kombic Surface 100
OpticTW 1500/2000



UGR <19 UGR <17

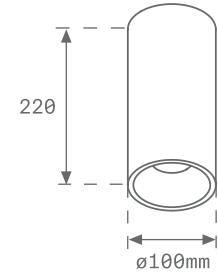

KOMBIC SURFACE 100 OPTIC WELLBEING WB

Familia	Instalación	Lm LED	IP	Óptica	K	Equipo	Acabados Refl	ctores	Acabados Ext.
K11	SF Surface	15 1500lm 20 2000lm	40 IP 43	WF Wide Flood 50°	WB3 3000 WB WB4 4000 WB	N ON/OFF D DALI	B Black M Metalized Matt W White		W White 02 B Black 02
K11	SF	15	40	WF	WB3	N	B		W

KOMBIC SURFACE 100 OPTIC TW

Familia	Instalación	Lm LED	IP	Óptica	IRC	K	Equipo	Acabados Refl	ctores	Acabados Ext.
K11	SF Surface	20 2000lm	40 IP 43	WF Wide Flood 50°	9 90	TW Tunable White	D DALI	B Black M Metalized Matt W White		W White 02 B Black 02
K11	SF	20	40	WF	9	TW	D	B		W





Kombic Surface 100
Refl ctor

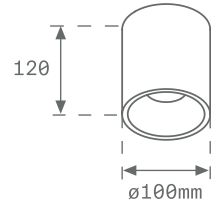

Kombic Surface 100
Refl ctor

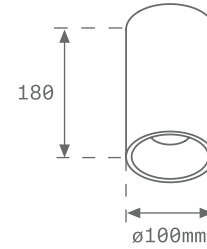

Kombic Surface 100
Refl ctor

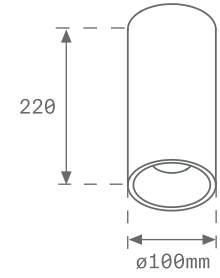

KOMBIC SURFACE 100 REFLECTOR

Familia	Instalación	Lm LED	IP	Óptica	IRC	K	Equipo	Acabados Refl ctres	Acabados Ext.
K11	SF Surface	15 1500lm	23 IP 23	RF Flood	9 90	27 2700 K	N ON/OFF D DALI	B Black M Metalized Matt W White	W White 02 B Black 02
		20 2000lm		RW Wide Flood					
	20 2000lm	23 IP 23	RF Flood	8 80	30 3000 K				
	25 2500lm		RW Wide Flood			40 4000 K			
K11	SF	15	23	RF	9	27	N	B	W



Kombic Surface 100 Track
Optic ON/OFF 1500/2000



Kombic Surface 100 Track
Optic DALI 1500/2000/2500
Optic ON/OFF 2500



Kombic Surface 100 Track
Optic TW 1500/2000

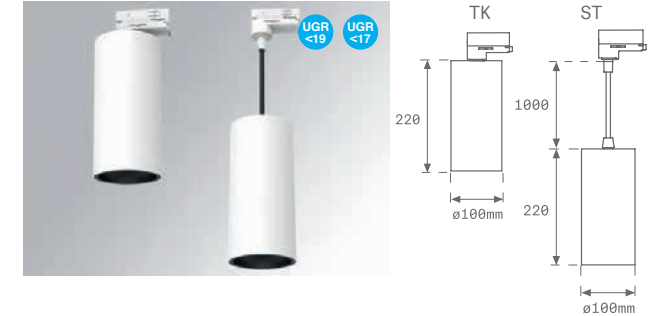

KOMBIC SURFACE 100 TRACK OPTIC

Familia	Instalación	Lm LED	IP	Óptica	IRC	K	Equipo	Acabados Refl. colores	Acabados Ext.
K11	TK Track	15 1500lm	40 IP 43	WF Wide Flood 50°	9 90	27 2700 K	N ON/OFF	B Black	W White 02
	ST Sus. Track	20 2000lm				30 3000 K	D DALI	M Metalized Matt	B Black 02
		20 2000lm	40 IP 43	WF Wide Flood 50°	8 80	30 3000 K		W White	
		25 2500lm				40 4000 K			
K11	TK	15	40	WF	9	27	N	B	W

KOMBIC SURFACE 100 TRACK OPTIC WELLBEING WB

Familia	Instalación	Lm LED	IP	Óptica	K	Equipo	Acabados Refl. colores	Acabados Ext.
K11	TK Track	15 1500lm	40 IP 43	WF Wide Flood 50°	WB3 3000 WB	N ON/OFF	B Black	W White 02
	ST Sus. Track	20 2000lm			WB4 4000 WB	D DALI	M Metalized Matt	B Black 02
K11	TK	15	40	WF	WB3	N	B	W

KOMBIC SURFACE 100 TRACK OPTIC TW

Familia	Instalación	Lm LED	IP	Óptica	IRC	K	Equipo	Acabados Refl. colores	Acabados Ext.
K11	TK Track	20 2000lm	40 IP 43	WF Wide Flood 50°	9 90	TW Tunable White	D DALI	B Black	W White 02
	ST Sus. Track							M Metalized Matt	B Black 02
K11	TK	20	40	WF	9	TW	D	B	W



CARACTERÍSTICAS TÉCNICAS

Ópticas

OPAL

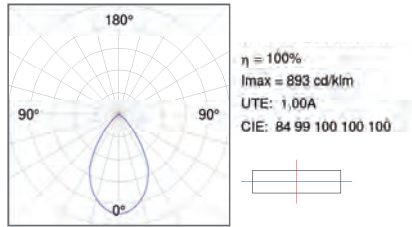

OPTIC

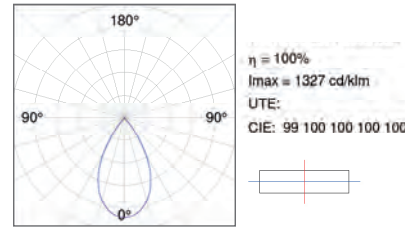

Flujo de salida y potencia

KOMBIC SURFACE 100 OPAL

	K	CRI	1500lm		2000lm		2500lm	
			W	lm Output	W	lm Output	W	lm Output
BR	2700	90	13,4	1191	19,1	1598	-	-
		80	-	-	-	-	-	-
	3000	90	13,4	1230	19,1	1648	-	-
		80	-	-	13,4	1460	19,1	1959
MA	2700	90	13,4	1336	19,1	1792	-	-
		80	-	-	13,4	1547	19,1	2082
	3000	90	13,4	1172	19,1	1571	-	-
		80	-	-	13,4	1392	19,1	1867
WH	2700	90	13,4	1273	19,1	1708	-	-
		80	-	-	13,4	1474	19,1	1978
	3000	90	13,4	1186	19,1	1591	-	-
		80	-	-	-	-	-	-
WH	2700	90	13,4	1225	19,1	1642	-	-
		80	-	-	13,4	1454	19,1	1951
	3000	90	13,4	1330	19,1	1785	-	-
		80	-	-	13,4	1541	19,1	2067

KOMBIC SURFACE 100 OPTIC

	K	CRI	1500lm		2000lm		2500lm	
			W	lm Output	W	lm Output	W	lm Output
BK	2700	90	13,4	983	19,1	1312	-	-
		80	-	-	-	-	-	-
	3000	90	13,4	1015	19,1	1354	-	-
		80	-	-	13,7	1205	19,8	1609
MA	2700	90	13,4	1102	19,1	1472	-	-
		80	-	-	13,7	1277	19,8	1704
	3000	90	13,4	1068	19,1	1424	-	-
		80	-	-	13,7	1268	19,8	1692
WH	2700	90	13,4	1160	19,1	1548	-	-
		80	-	-	13,7	1343	19,8	1792
	3000	90	13,4	1040	19,1	1387	-	-
		80	-	-	-	-	-	-
WH	2700	90	13,4	1074	19,1	1432	-	-
		80	-	-	13,7	1275	19,8	1701
	3000	90	13,4	1166	19,1	1556	-	-
		80	-	-	13,7	1351	19,8	1802



CARACTERÍSTICAS TÉCNICAS

Flujo de salida y potencia

KOMBIC SURFACE 100 OPAL WELLBEING

	K	CRI	1200lm		1800lm	
			W	lm Output	W	lm Output
BR	3000	95	13,9	971	20	1316
	4000	95	13,9	1031	20	1394
MA	3000	95	13,9	929	20	1243
	4000	95	13,9	986	20	1317
WH	3000	95	13,9	951	20	1206
	4000	95	13,9	1035	20	1398

KOMBIC SURFACE 100 OPTIC WELLBEING

	K	CRI	1200lm		1800lm	
			W	lm Output	W	lm Output
BK	3000	95	13,9	835	20	1109
	4000	95	13,9	885	20	1175
MA	3000	95	13,9	862	20	1185
	4000	95	13,9	914	20	1255
WH	3000	95	13,9	857	20	1057
	4000	95	13,9	947	20	1263

KOMBIC SURFACE 100 REFLECTOR WF

	K	CRI	1500lm		2000lm		2500lm		
			W	lm Output	W	lm Output	W	lm Output	
WF	BK	2700	90	14,5	1168	19,8	1568	-	-
		80	-	-	-	-	-	-	-
	3000	90	14,5	1218	19,8	1636	-	-	
		80	-	-	14,5	1421	19,8	1908	
	4000	90	14,5	1299	19,8	1744	-	-	
		80	-	-	14,5	1491	19,8	2002	
MA	2700	90	14,5	1264	19,8	1710	-	-	
		80	-	-	-	-	-	-	
	3000	90	14,5	1318	19,8	1784	-	-	
		80	-	-	14,5	1538	19,8	2081	
	4000	90	14,5	1406	19,8	1902	-	-	
		80	-	-	14,5	1614	19,8	2184	
WH	2700	90	14,5	1264	19,8	1710	-	-	
		80	-	-	-	-	-	-	
	3000	90	14,5	1318	19,8	1784	-	-	
		80	-	-	14,5	1538	19,8	2081	
	4000	90	14,5	1406	19,8	1902	-	-	
		80	-	-	14,5	1614	19,8	2184	

KOMBIC SURFACE 100 REFLECTOR FL

	K	CRI	1500lm		2000lm		2500lm		
			W	lm Output	W	lm Output	W	lm Output	
FL	BK	2700	90	14,5	1273	19,8	1711	-	-
		80	-	-	-	-	-	-	
	3000	90	14,5	1328	19,8	1785	-	-	
		80	-	-	14,5	1549	19,8	2082	
	4000	90	14,5	1416	19,8	1903	-	-	
		80	-	-	14,5	1226	19,8	2185	
MA	2700	90	14,5	1325	19,8	1815	-	-	
		80	-	-	-	-	-	-	
	3000	90	14,5	1382	19,8	1893	-	-	
		80	-	-	14,5	1612	19,8	2208	
	4000	90	14,5	1474	19,8	2019	-	-	
		80	-	-	14,5	1692	19,8	2318	
WH	2700	90	14,5	1325	19,8	1815	-	-	
		80	-	-	-	-	-	-	
	3000	90	14,5	1382	19,8	1893	-	-	
		80	-	-	14,5	1612	19,8	2208	
	4000	90	14,5	1474	19,8	2019	-	-	
		80	-	-	14,5	1692	19,8	2318	



ACCESORIOS

Suspensión rígida para conexión eléctrica



Ref.	Color	m
K1SUCARG0500NW	○	0,5
K1SUCARG0500DW	○	0,5
K1SUCARG0500NB	●	0,5
K1SUCARG0500DB	●	0,5
K1SUCARG1000NW	○	1
K1SUCARG1000DW	○	1
K1SUCARG1000NB	●	1
K1SUCARG1000DB	●	1

Suspensión



Ref.	Color	m
K1SUCAWI2000NW	○	2
K1SUCAWI2000DW	○	2
K1SUCAWI2000NB	●	2
K1SUCAWI2000DB	●	2

Pasacables



Ref.	Color
K11SUADLATWH	○
K11SUADLATBK	●

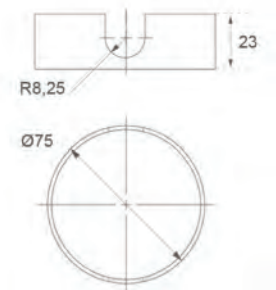



Kombic Surface 150

Opal

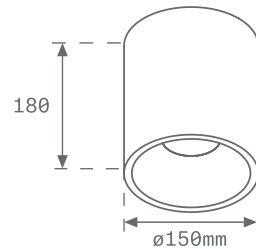

KOMBIC SURFACE 150 OPAL

Familia	Instalación	Lm LED	IP	Óptica	IRC	K	Equipo	Acabados Reflectores	Acabados Ext.				
K21	SF Surface	20 2000lm	40 IP 43	OP Opal	9 90	27 2700 K	N ON/OFF	R Bright	W White 02				
		30 3000lm								40 4000 K	D DALI	M Metalized Matt	B Black 02
		35 3500lm											
K21	SF	20	40	OP	9	27	N	R	W				

KOMBIC SURFACE 150 OPAL WELLBEING WB

Familia	Instalación	Lm LED	IP	Óptica	K	Equipo	Acabados Reflectores	Acabados Ext.
K21	SF Surface	20 2000lm	40 IP 43	OP Opal	WB3 3000 WB	N ON/OFF	R Bright	W White 02
		25 2500lm			WB4 4000 WB			
K21	SF	20	40	OP	WB3	N	R	W

KOMBIC SURFACE 150 OPAL TW

Familia	Instalación	Lm LED	IP	Óptica	IRC	K	Equipo	Acabados Reflectores	Acabados Ext.
K21	SF Surface	30 3000lm	40 IP 43	OP Opal	9 90	TW Tunable White	D DALI	R Bright	W White 02
								M Metalized Matt	B Black 02
								W White	
K21	SF	30	40	OP	9	TW	D	R	W





Kombic Surface 150

Optic

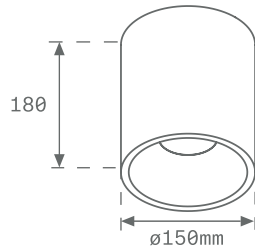

KOMBIC 150 OPTIC

Familia	Instalación	Lm LED	IP	Óptica	IRC	K	Equipo	Acabados Reflectores	Acabados Ext.
K21	SF Surface	20 2000lm	40 IP 43	WF Wide Flood 50°	9 90	27 2700 K	N ON/OFF D DALI	B Black M Metalized Matt W White	W White 02 B Black 02
		30 3000lm							
		20 2000lm 30 3000lm 35 3500lm							
K21	SF	20	40	WF	9	27	N	B	W

KOMBIC SURFACE 150 OPTIC WELLBEING ^{WB}

Familia	Instalación	Lm LED	IP	Óptica	K	Equipo	Acabados Reflectores	Acabados Ext.
K21	SF Surface	20 2000lm	40 IP 43	WF Wide Flood 50°	WB3 3000 WB WB4 4000 WB	N ON/OFF D DALI	B Black M Metalized Matt W White	W White 02 B Black 02
		25 2500lm						
K121	SF	20	40	WF	WB3	N	B	W

KOMBIC SURFACE 150 OPTIC TW

Familia	Instalación	Lm LED	IP	Óptica	IRC	K	Equipo	Acabados Reflectores	Acabados Ext.
K21	SF Surface	30 3000lm	40 IP 43	WF Wide Flood 50°	9 90	TW Tunable White	D DALI	B Black M Metalized Matt W White	W White 02 B Black 02
K21	SF	30	40	WF	9	TW	D	B	W





CARACTERÍSTICAS TÉCNICAS

Ópticas

OP

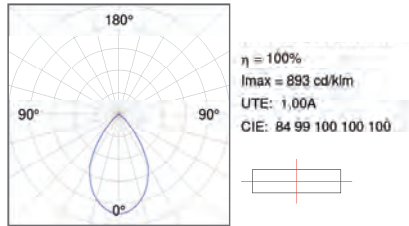

WFL 50°

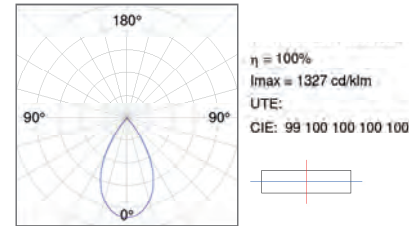

Flujo de salida y potencia

KOMBIC SURFACE 150 OPAL

	K	CRI	2000lm		3000lm		3500lm	
			W	lm Output	W	lm Output	W	lm Output
BR	2700	90	19,8	1675	27,7	2227	-	-
		80	-	-	-	-	-	-
	3000	90	19,8	1739	27,7	2312	-	-
		80	13,4	1488	19,9	2096	27,7	2788
	4000	90	19,8	1874	27,7	2492	-	-
		80	13,4	1550	19,9	2184	27,7	2904
TW	90	23,9	1653	-	-	-	-	
MA	2700	90	19,8	1606	27,7	2135	-	-
		80	-	-	-	-	-	-
	3000	90	19,8	1667	27,7	2216	-	-
		80	13,4	1427	19,9	2010	27,7	2673
	4000	90	18	1797	27,7	2389	-	-
		80	12	1486	19,9	2094	27,7	2784
TW	90	23,9	1737	-	-	-	-	
WH	2700	90	19,8	1658	27,7	2203	-	-
		80	-	-	-	-	-	-
	3000	90	19,8	1720	27,7	2288	-	-
		80	13,4	1473	19,9	2074	27,7	2759
	4000	90	18	1854	27,7	2466	-	-
		80	12	1534	19,9	2161	27,7	2874
TW	90	23,9	1721	-	-	-	-	

KOMBIC SURFACE 150 OPTIC

	K	CRI	2000lm		3000lm		3500lm	
			W	lm Output	W	lm Output	W	lm Output
BK	2700	90	19,8	1289	27,7	1713	-	-
		80	-	-	-	-	-	-
	3000	90	19,8	1739	27,7	1779	-	-
		80	13,4	1145	19,9	1613	27,7	2145
	4000	90	19,8	1874	27,7	1917	-	-
		80	13,4	1193	19,9	1680	27,7	2235
TW	90	23,9	1352	-	-	-	-	
MA	2700	90	19,8	1293	27,7	1718	-	-
		80	-	-	-	-	-	-
	3000	90	19,8	1667	27,7	1784	-	-
		80	13,4	1148	19,9	1618	27,7	2151
	4000	90	18	1797	27,7	1923	-	-
		80	12	1196	19,9	1685	27,7	2241
TW	90	23,9	1362	-	-	-	-	
WH	2700	90	19,8	1332	27,7	1771	-	-
		80	-	-	-	-	-	-
	3000	90	19,8	1720	27,7	1838	-	-
		80	13,4	1184	19,9	1677	27,7	2217
	4000	90	18	1854	27,7	1982	-	-
		80	12	1233	19,9	1737	27,7	2310
TW	90	23,9	1381	-	-	-	-	

Kombic Surface | Indoor

CARACTERÍSTICAS TÉCNICAS



PRESENTACIÓN FAMILIA

Ind.



Flujo de salida y potencia

KOMBIC SURFACE 150 OPAL WELLBEING

	K	CRI	2000lm		2500lm	
			W	lm Output	W	lm Output
BR	3000	97	19	1368	27,4	1932
	4000	97	19	1491	27,4	2190
MA	3000	97	19	1308	27,4	1884
	4000	97	19	1429	27,4	2075
WH	3000	97	19	1361	27,4	1951
	4000	97	19	1474	27,4	2170

KOMBIC SURFACE 150 OPTIC WELLBEING

	K	CRI	2000lm		2500lm	
			W	lm Output	W	lm Output
BK	3000	97	19	1192	27,4	1543
	4000	97	19	1297	27,4	1652
MA	3000	97	19	1205	27,4	1567
	4000	97	19	1321	27,4	1713
WH	3000	97	19	1208	27,4	1596
	4000	97	19	1335	27,4	1711

ACCESORIOS

Suspensión rígida para conexión eléctrica



Ref.	Color	m
K2SUCARG0500NW	○	0,5
K2SUCARG0500DW	○	0,5
K2SUCARG0500NB	●	0,5
K2SUCARG0500DB	●	0,5
K2SUCARG1000NW	○	1
K2SUCARG1000DW	○	1
K2SUCARG1000NB	●	1
K2SUCARG1000DB	●	1

Suspensión



Ref.	Color	m
K2SUCAWI2000NW	○	2
K2SUCAWI2000DW	○	2
K2SUCAWI2000NB	●	2
K2SUCAWI2000DB	●	2

Pasacables



Ref.	Color
K21SUADLATWH	○
K21SUADLATBK	●

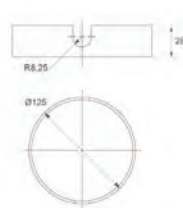



Kombic Surface 200

Opal

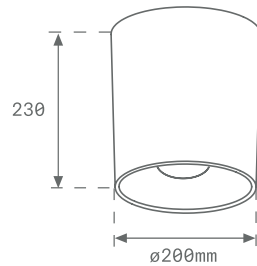

KOMBIC 200 OPAL

Familia	Instalación	Lm LED	IP	Óptica	IRC	K	Equipo	Acabados Refl	ctores	Acabados Ext.
K32	SF Surface	30 3000lm 40 4000lm	20 IP 20	OP Opal	8 80	30 3000 K 40 4000 K	N ON/OFF	R Bright W White		W White O2 B Black O2
K32	SF	30	20	OP	8	30	N	R		W

CARACTERÍSTICAS TÉCNICAS

Ópticas

OPAL

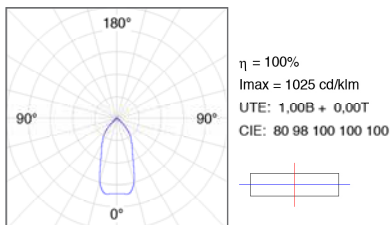

Flujo de salida y potencia

KOMBIC 200 SURFACE OPAL

	K	CRI	3000lm		4000lm	
			W	lm Output	W	lm Output
BR	3000	80	16,7	2181	24,1	3025
	4000	80	16,7	2304	24,1	3195
WH	3000	80	16,7	2181	24,1	3025
	4000	80	16,7	2304	24,1	3195





ACCESORIOS

Suspensión electromecánica de dos cables acero



Ref.	Color	h(m)
SUEM2W3000NW	○	max. 3
SUEM2W3000NG	●	max. 3

Embellecedor superior para modelo suspendido

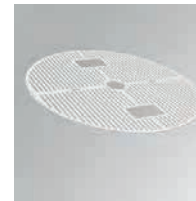

Ref.	Color
K3SUC0W	○

Rígida electromecánica



Ref.	Color	h(mm)
SUCARG0100W	○	100
SUCARG0100G	●	100
SUCARG0250W	○	250
SUCARG0250G	●	250
SUCARG0500W	○	500
SUCARG0500G	●	500
SUCARG01000W	○	1000
SUCARG01000G	●	1000



Lamptub 60



Lamptub 60
Suspended Direct Rec



Lamptub 60
Suspended Direct Sur

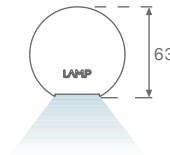

Lamptub 60
Suspended Dir/Ind

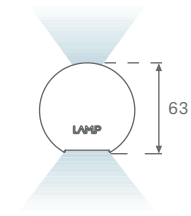

LAMPTUB 60 SUSPENDE DIRECT

Familia	Instalación	Florón	Formato	Lm LED/m	Óptica	IRC	K	Equipo	Acabados			
L61	S Suspended	E Recessed	084 840mm	LO 1500lm	OP Opal	9 90	27 2700 K	N ON/OFF	W White			
		S Surface	112 1120mm	MO 3000lm	OC Opal Comfort					30 3000 K	D DALI	B Black
			168 1680mm							40 4000 K		3 Wellbeing
L61	S Suspended	E Recessed	084 840mm	MO 2600lm	TE Tech	9 90	30 3000 K	N ON/OFF	W White			
		S Surface	112 1120mm							40 4000 K	D DALI	B Black
			168 1680mm									3 Wellbeing
L61	S Suspended	E Recessed	084 840mm	LO 1500lm	OC Opal Comfort	9 90	TW Tunable White	D DALI	W White			
		S Surface	112 1120mm	MO 3000lm						3 Wellbeing	4 Be Social	
			168 1680mm									
L61	S	E	084	LO	OP	9	27	N	W			

LAMPTUB 60 SUSPENDE DIR/IND

Familia	Instalación	Florón	Formato	Lm LED/m	Óptica	IRC	K	Equipo	Acabados			
L61	S Suspended	E Recessed	084 840mm	LO 1500lm	IO Dir/Ind Opal	9 90	27 2700 K	N ON/OFF	W White			
			112 1120mm	MO 2600lm	IP Dir/Ind Opal Comfort					30 3000 K	D DALI	B Black
			168 1680mm							40 4000 K		3 Wellbeing
L61	S Suspended	E Recessed	084 840mm	LO 1500lm	IP Dir/Ind Opal Comfort	9 90	TW Tunable White	D DALI	W White			
			112 1120mm	MO 2600lm						3 Wellbeing	4 Be Social	
			168 1680mm									
L61	S	E	084	LO	IO	9	27	N	W			





NS

Lamptub 60
Track Surface



Lamptub 60
Track Suspended

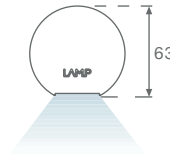

Lamptub 60
Track Dir/Ind

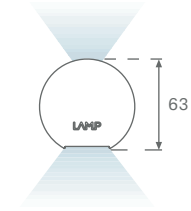

LAMPTUB 60 TRACK DIRECT

Familia	Instalación	Formato	Lm LED/m	Óptica	IRC	K	Equipo	Acabados
L61	TK Track Surface	084 840mm	LO 1500lm	OP Opal	9 90	27 2700 K 30 3000 K 40 4000 K	N ON/OFF D DALI	W White
	ST Track Suspended	112 1120mm 168 1680mm	MO 3000lm	OC Opal Comfort				B Black
								3 Wellbeing 4 Be Social
L61	TK Track Surface	084 840mm	MO 2600lm	TE Tech	9 90	30 3000 K 40 4000 K	N ON/OFF D DALI	W White
	ST Track Suspended	112 1120mm 168 1680mm						B Black
								3 Wellbeing 4 Be Social
L61	TK	084	LO	OP	9	27	N	W

LAMPTUB 60 TRACK DIR/IND

Familia	Instalación	Formato	Lm LED/m	Óptica	IRC	K	Equipo	Acabados
L61	ST Track Suspended	084 840mm	LO 1500lm	IO Dir/Ind Opal	9 90	27 2700 K 30 3000 K 40 4000 K	N ON/OFF D DALI	W White
		112 1120mm	MO 2600lm	IP Dir/Ind Opal Comfort				B Black
		168 1680mm						3 Wellbeing 4 Be Social
L61	ST	084	LO	IO	9	27	N	W



CARACTERÍSTICAS TÉCNICAS

Ópticas

OP

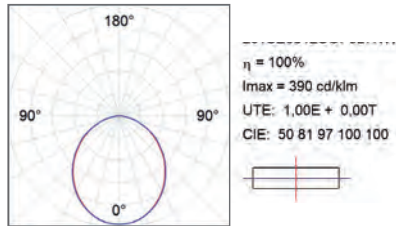

OC

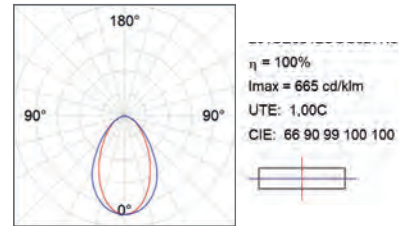

TE

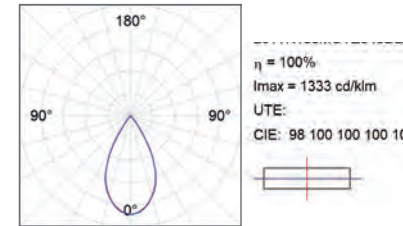

Flujo de salida y potencia

LAMPTUB 60 DIRECT

				840mm		1120mm		1680mm		
		K	CRI	W	lm Output	W	lm Output	W	lm Output	
LO	OP	2700	90	9,7	716	12,9	955	17,9	1433	
		3000	90	9,7	754	12,9	1005	17,9	1508	
		4000	90	9,7	778	12,9	1038	17,9	1556	
	OC	2700	90	9,7	663	12,9	884	17,9	1326	
		3000	90	9,7	698	12,9	931	17,9	1396	
		4000	90	9,7	720	12,9	961	17,9	1441	
MO	OP	2700	90	17,8	1468	25,4	1957	34,7	2936	
		3000	90	17,8	1544	25,4	2060	34,7	3089	
		4000	90	17,8	1594	25,4	2126	34,7	3189	
	OC	2700	90	17,8	1358	25,4	1912	34,7	2717	
		3000	90	17,8	1430	25,4	1906	34,7	2860	
		4000	90	17,8	1476	25,4	1968	34,7	2951	
	TE	2700	-	-	-	-	-	-	-	-
		3000	90	13,7	1260	17,8	1680	26,7	2520	
		4000	90	13,7	1320	17,8	1760	26,7	2640	

CARACTERÍSTICAS TÉCNICAS

Ópticas

I0

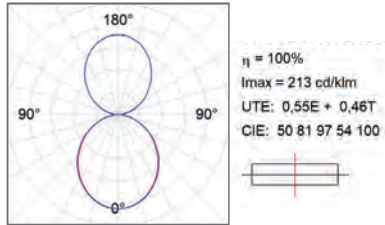

IP

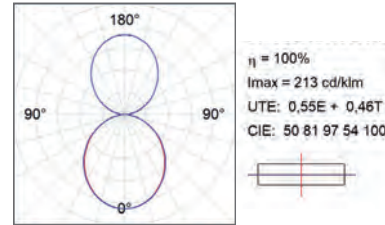

Flujo de salida y potencia

LAMPTUB 60 DIRECT/INDIRECT

				840mm		1120mm		1680mm		
		K	CRI	W	lm Output	W	lm Output	W	lm Output	
LO	IO	2700	90	7,9	600	10,6	840	18,5	1320	
				9,5	717	12	955	17	1433	
		3000	90	7,9	632	10,6	884	17	1389	
					9,5	754	12	1005	17	1508
			4000	90	7,9	652	10,6	912	17	1433
					9,5	778	12	1038	17	1557
	IP	2700	90	7,9	599	10,6	840	17	1319	
				9,5	662	12	884	34	1327	
		3000	90	7,9	630	10,6	883	17	1388	
					9,5	698	12	931	17	1396
4000		90	7,9	651	10,6	911	17	1433		
					9,5	720	12	961	17	1441
MO	IO	2700	90	7,9	600	11	841	17	1321	
				18	1468	25	1957	34	2936	
		3000	90	7,9	632	11	884	17	1390	
					18	1545	25	2060	34	3089
	4000	90	7,9	652	11	913	17	1434		
					18	1594	25	2126	34	3189
	IP	2700	90	7,9	600	11	839	17	1320	
				18	1359	25	1812	34	2717	
		3000	90	7,9	631	11	884	17	1388	
					18	1430	25	1906	34	2860
4000		90	7,9	651	11	912	17	1433		
					18	1476	25	1968	34	2951



ACCESORIOS

Tapa final



Ref.

L6SUECB
L6SUECW
L6SUECW3
L6SUECW4

Color



Paletas Be Social: W4



4050-R90B



1050-B10G



7502-R



2070-Y80R



2011

Paletas Wellbeing: W3



4050-R90B



1505-Y10R



7024



4030-B50G



7001



Lamptub 80



Lamptub 80

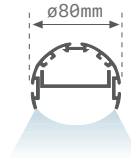

LAMPTUB 80

Familia	Instalación	Formato	Lm LED/m	Óptica	IRC	K	Equipo	Acabados
LA1	SF Surface	120 1162mm	LO 2320	OP Opal	8 80	30 3000 K	N ON/OFF	W White 02
		170 1743mm	MO 3928					
LA1	SF	170	LO	OP	8	30	N	W

CARACTERÍSTICAS TÉCNICAS

Ópticas

OP

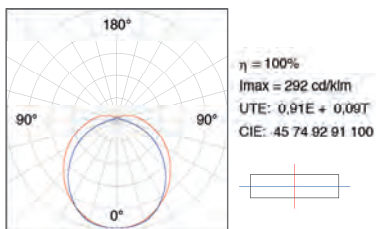

Flujo de salida y potencia

LAMPTUB 80

				1162lm		1743lm	
		K	CRI	W	lm Output	W	lm Output
LO	LO	3000	80	19,2	2278	29,7	3601
		4000	80	19,2	2322	29,7	3683
MO	OP	3000	80	30,7	3896	45,8	6161
		4000	80	30,7	3986	45,8	6299





ACCESORIOS

Perfil y tapa (max. 3m)

Ref.	Color
LAPRSUX/MMW	<input type="radio"/>
LACOSUX/MMW	<input type="radio"/>

Tapa final

Ref.	Color
LASUECW	<input type="radio"/> 

Unión codo 90°

Ref.	Color
LASUHCW	<input type="radio"/> 

Difusor opal

Ref.	Color
LADIX/MMOP	<input type="radio"/>

Juego de 2 fijaciones para unión (2 unidades por referencia)

Ref.
F5J0

Soporte pared con tapa incorporada (2 unidades por referencia)

FINAL Ref.	Color	INTERMEDIO Ref.	Color
LAWASFEDW	<input type="radio"/>	LAWASFIDW	<input type="radio"/>

Unión soporte pared

Ref.	Color	Lmm
F5FX75W	<input type="radio"/>	75



Modular Custom



Modular Custom Air



MODULAR CUSTOM AIR

Familia	Formato	Lm LED	Óptica	IRC	K	Equipo	Acabados
MCA1	1212 1200x120	35 3400lm	PR Prismatic	8 80	30 3000 K 40 4000 K	N ON/OFF D DALI	W White 04
	1230 1200x300	45 4500lm					
	9030 900x300	35 3500lm					
MCA1	1230	45	PR	8	40	N	W

Consultar dimensiones disponibles para integración en diferentes formatos de techos y accesorios en la **presentación de familia**.

CARACTERÍSTICAS TÉCNICAS

Ópticas

PR

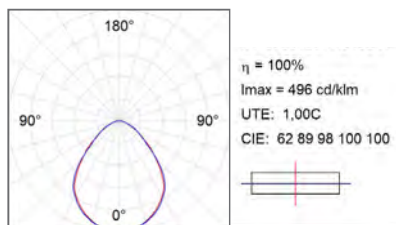



Modular Custom Efficiency



MODULAR CUSTOM EFFICIENCY

Familia	Formato	Lm LED	Óptica	IRC	K	Equipo	Acabados
MCE1	1212 1200x120	40 4000lm	PR Prismatic	8 80	30 3000 K 40 4000 K	N ON/OFF	W White 04
	1230 1200x300	50 5000lm					
MCE1	1212	40	PR	8	30	N	W

Consultar dimensiones disponibles para integración en diferentes formatos de techos y accesorios en la **presentación de familia**.

CARACTERÍSTICAS TÉCNICAS

Ópticas

PR

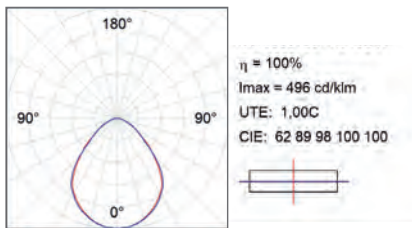



ACCESORIOS

Sistema de anclaje para techos 3, 4, 5 y 6
(4 unidades por referencia, no incluidas en la luminaria)



Ref.

MLREFX

Color



Posibles techos de aplicación de la luminaria

1

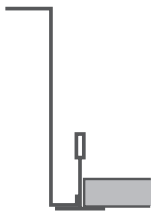

Perfil ría vista

2

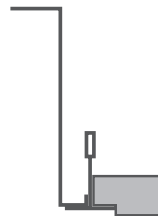

Perfil ría vista,
placa semi-empotrada

3

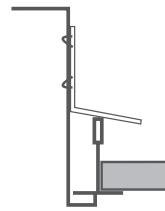

Perfil ría vista, luminaria
semi-empotrada

4

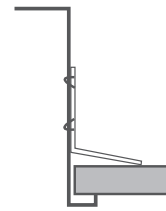

Techo de yeso, luminaria
semi-empotrada

5

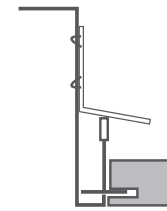

Perfil ría "T" oculta,
techo no desmontable

6

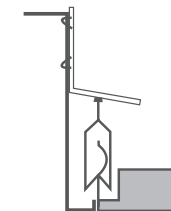

Perfil ría para techo de
placas metálicas

7

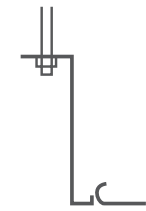

Montaje suspendido
para techos de lamas o
especiales



Moody



PRESENTACIÓN FAMILIA

Ind.



Moody
Core 800

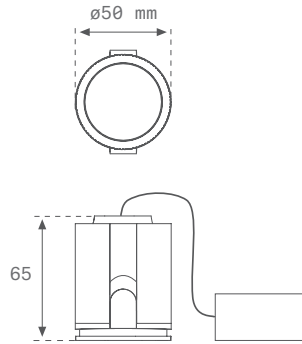

Moody
Core 1700

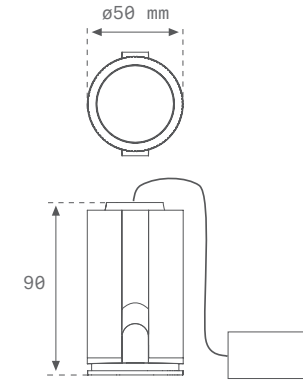

MOODY

Familia	Lm LED	Óptica	IRC	K	Equipo	Acabados
M02	08 800lm	SP SP 17°	9 90	27 2700 K	T TRIAC	B Black 07
	15 1700lm	FL FL 36°	8 80	30 3000 K	D DALI	
		WF WFL 55°		40 4000 K		
M02	08	SP	9	27	T	B



CARACTERÍSTICAS TÉCNICAS

Ópticas

SP 18°

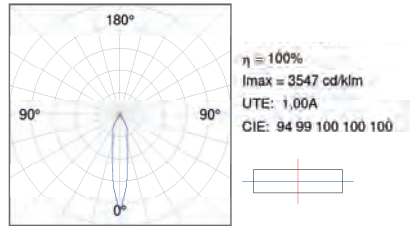

FL 36°

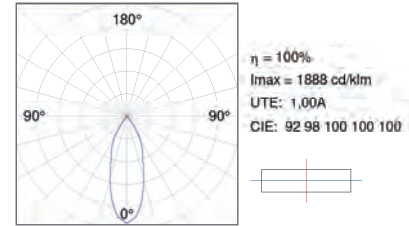

WFL 55°

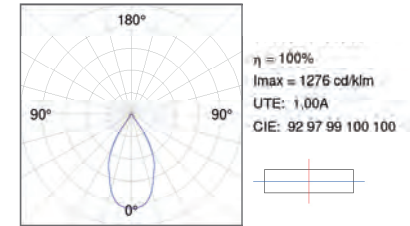

Flujo de salida y potencia



MOODY

	K	CRI	800lm		1500lm	
			W	lm Output	W	lm Output
SP	2700	90	6,1	435	14	927
17°	3000	80	6,1	533	14	1137
	4000	80	6,1	565	14	1204





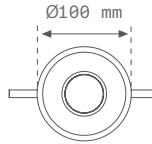

REFLECTORES

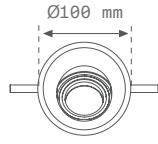

Reflector Moody redondo fijo

	Ref.	Color	Pict.	
	MORFRD100FXB	●		
	MORFRD100FXC	●		
	MORFRD100FXM	●		
	MORFRD100FXW	○		

Reflector Moody redondo orientable

	Ref.	Color	Pict.	
	MORFRD100ADB	●		
	MORFRD100ADC	●		
	MORFRD100ADM	●		
	MORFRD100ADW	○		

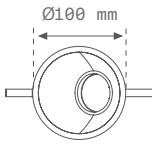

Reflector Moody redondo asimétrico

	Ref.	Color	Pict.	
	MORFRD100ASB	●		
	MORFRD100ASC	●		
	MORFRD100ASM	●		
	MORFRD100ASW	○		

Reflector Moody cuadrado fijo

	Ref.	Color	Pict.	
	MORFSQ100FXB	●		
	MORFSQ100FXC	●		
	MORFSQ100FXM	●		
	MORFSQ100FXW	○		

Reflector Moody mini

	Ref.	Color	Pict.	
	MORFRD072FXB	●		
	MORFRD072FXC	●		
	MORFRD072FXM	●		
	MORFRD072FXW	○		

Reflector Moody IP55

	Ref.	Color
	MORFRD100FX55B	●
	MORFRD100FX55W	○



ACCESORIOS

Difusor transparente



Ref.
MOTRIP44

Pict.
**IP
44**

Refractor para distribución elíptica del flujo luminoso



Ref.
MOEL

Pict.
**IP
44**

Rejilla antideslumbrante tipo panel

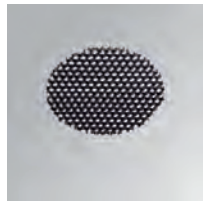

Ref.
MOHOB

Recortador de haz



Ref.
**MOCUFL
MOCUMF
MOCUVWF**

Pict.
**IP
44**
-

Adaptador portalámparas



Ref.
**MOADGU10
MOADGU53**

Pict.
**GU10
PAR51-LED
GU 5,3
MR16-LED**



Moody Core 800 con reflector para empotrar

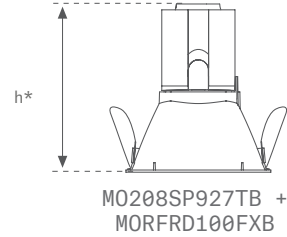
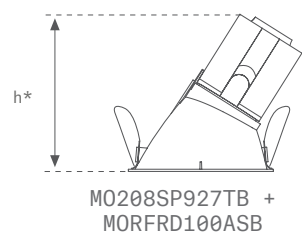

* Consultar altura (h) en hoja instrucciones

Moody Core 1700 con reflector para empotrar

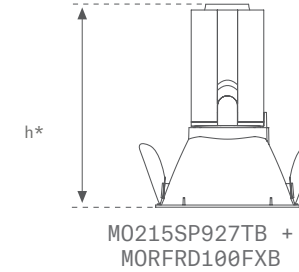
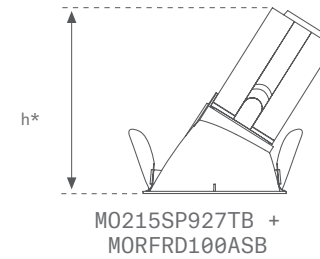

* Consultar altura (h) en hoja instrucciones

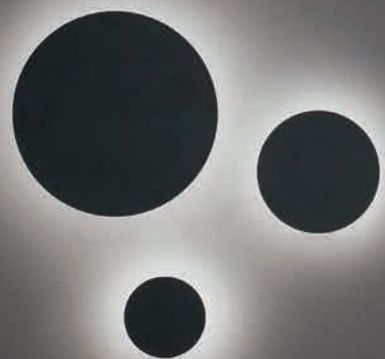

Mun Dark



Mun Dark
120



Mun Dark
180

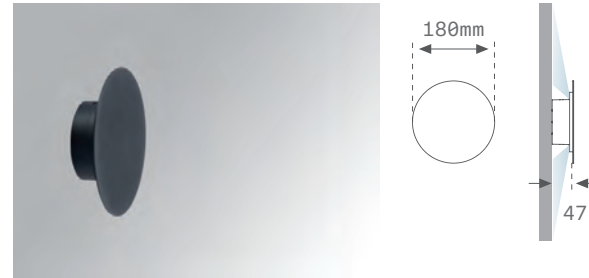

Mun Dark
300

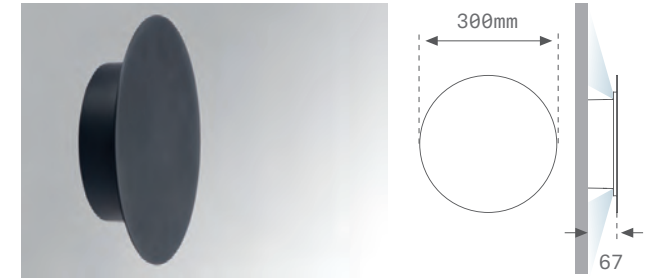

MUN DARK 120

Familia	Formato	Instalación	Lm LED	IP	IRC	K	Equipo	Acabados
MD1	120 120mm	SF Surface	01 100lm	20 20	8 80	30 3000 K 40 4000 K	N ON/OFF	W White 05 B Black 05
MD1	120	SF	01	20	8	30	N	W

MUN DARK 180

Familia	Formato	Instalación	Lm LED	IP	IRC	K	Equipo	Acabados
MD1	180 180mm	SF Surface	01 150lm	20 20	8 80	30 3000 K 40 4000 K	N ON/OFF	W White 05 B Black 05
MD1	180	SF	01	20	8	30	N	W

MUN DARK 300

Familia	Formato	Instalación	Lm LED	IP	IRC	K	Equipo	Acabados
MD1	300 300mm	SF Surface	01 300lm	20 20	8 80	30 3000 K 40 4000 K	N ON/OFF	W White 05 B Black 05
MD1	300	SF	01	20	8	30	N	W



CARACTERÍSTICAS TÉCNICAS

Ópticas

MUN DARK 120

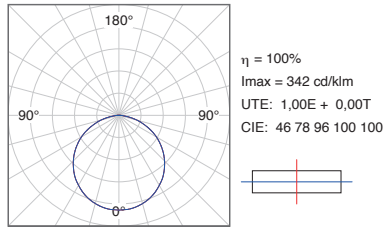

MUN DARK 180

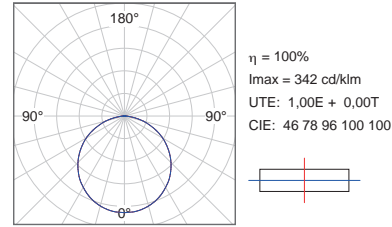

MUN DARK 300

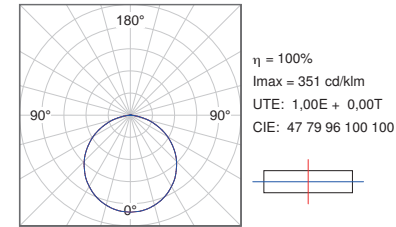

Flujo de salida y potencia

MUN DARK 120

100lm

Color	K	CRI	W	lm Output
W	3000	80	1	30
B	4000	80	1	30

MUN DARK 180

150lm

Color	K	CRI	W	lm Output
W	3000	80	1	45
B	4000	80	1	45

MUN DARK 300

300lm

Color	K	CRI	W	lm Output
W	3000	80	3	90
B	4000	80	3	90



Mun Light

Mun Light | Indoor



PRESENTACIÓN FAMILIA

Ind.



Mun Light
350

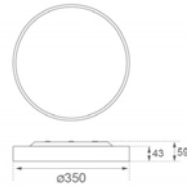

Mun Light
450

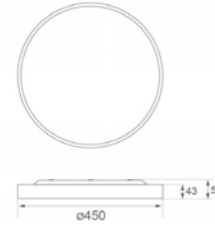

Mun Light
600

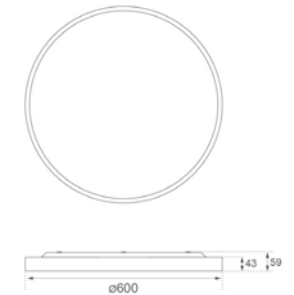

MUN LIGHT

Familia	Instalación	Formato	Lm LED	Óptica	IRC	K	Equipo	Acabados
ML2	SF Surface	35 350mm	LO 1800 MO 2800	PR Prismatic	9 90	30 3000 K 40 4000 K	N ON/OFF D DALI	W White 05 B Black 05
		45 450mm	LO 2600 MO 4500					
		60 600mm	LO 4800 MO 7100					
ML2	SF	35	MO	PR	9	30	N	W

CARACTERÍSTICAS TÉCNICAS

Ópticas

MUN LIGHT 350

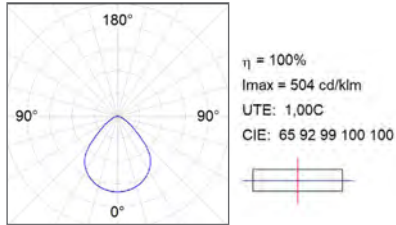

MUN LIGHT 450

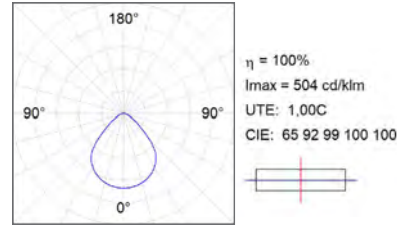

MUN LIGHT 600

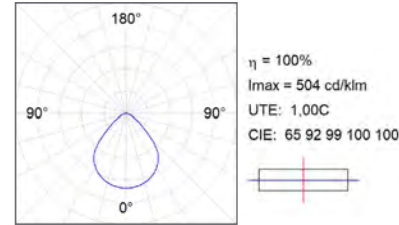

Flujo de salida y potencia

MUN LIGHT

	K	CRI	350mm		450mm		600mm	
			W	lm Output	W	lm Output	W	lm Output
LO B/W	3000	90	12	1254	16,5	1820	26,8	3285
	4000	90	12	1392	16,5	2020	26,8	3646
MO B/W	3000	90	16,6	1881	26,8	3046	39,9	4819
	4000	90	16,6	2113	26,8	3381	39,9	5349

ACCESORIOS

Suspensión



Ref.	Color	mm
ML2SUEMSF1500NW	○	1500
ML2SUEMSF1500NB	●	1500
ML2SUEMSF3000NW	○	3000
ML2SUEMSF3000NB	●	3000
ML2SUEMSF1500DW	○	1500
ML2SUEMSF1500DB	●	1500
ML2SUEMSF3000DW	○	3000
ML2SUEMSF3000DB	●	3000



Ocult Downlight

Ocult Downlight
Recessed 2 Modules

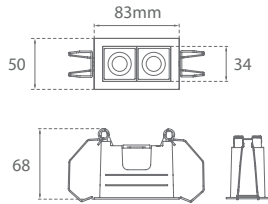

Ocult Downlight
Recessed 3 Modules

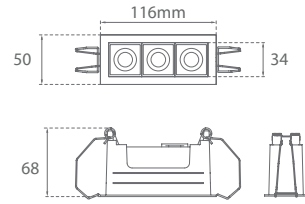

Ocult Downlight
Recessed 6 Modules

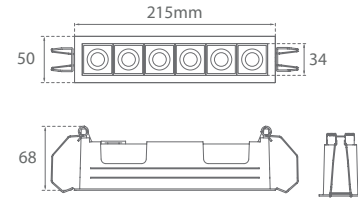

Ocult Downlight
Recessed 9 Modules

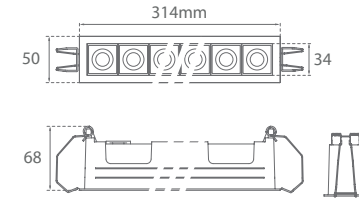

Ocult Downlight
Recessed 12 Modules

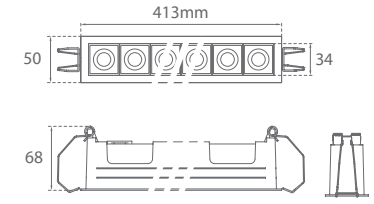

OCULT RECESSED

Familia	Instalación	Módulos	Lm LED	Óptica	IRC	K	Equipo	Acabados Int.	AcabadosExt.			
OD1	RE Recessed	2	04 400lm	MF MFL 24°	8 80	30 3000 K	N ON/OFF	B Black 03	B Black 03			
		3	06 600lm	WF WFL 48°						40 4000 K	D DALI	W White 03
		6	12 1200lm									
		9	18 1800lm									
		12	22 2400lm									
OD1	RE	2	04	MF	8	30	N	B	B			





CARACTERÍSTICAS TÉCNICAS

Ópticas

MFL 24°

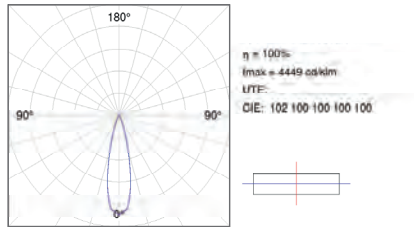

UGR <10
Para 4H, 8H 70/ 50 /20

WFL 48°

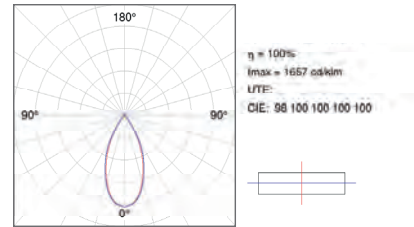

UGR <19
Para 4H, 8H 70/ 50 /20

Datos dimensionales

	2 Modules	3 Modules	6 Modules	9 Modules	12 Modules
XxY	43x74	43x107	43x207	43x307	43x407



Flujo de salida y potencia

OCULT DOWNLIGHT

	K	CRI	2 Modules		3 Modules		6 Modules		9 Modules		12 Modules	
			W	lm Output	W	lm Output	W	lm Output	W	lm Output	W	lm Output
MFL 24°	3000	80	5	360	8	540	14	1080	20	1620	26,7	2160
	4000	80	5	360	8	540	14	1080	20	1620	26,7	2160
WFL 48°	3000	80	5	366	8	549	14	1098	20	1647	26,7	2196
	4000	80	5	366	8	549	14	1098	20	1647	26,7	2196

ACCESORIOS

Refl ctor (2 módulos)



Ref.

ODRF2C
ODRF2M
ODRF2W

Color



Refl ctor (3,6,9,12 módulos)



Ref.

ODRF3C
ODRF3M
ODRF3W

Color



Ocult Downlight Trimless 2 Modules

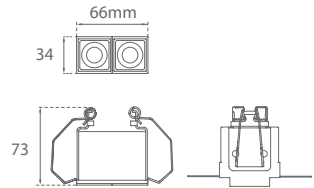
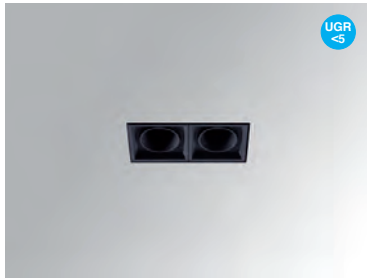

Ocult Downlight Trimless 3 Modules

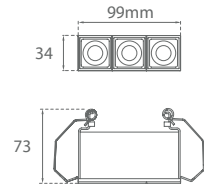

Ocult Downlight Trimless 6 Modules

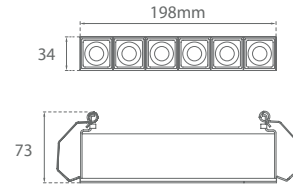

Ocult Downlight Trimless 9 Modules

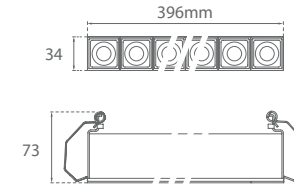

Ocult Downlight Trimless 12 Modules

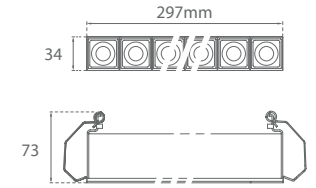

OCULT TRIMLESS

Familia	Instalación	Módulos	Lm LED	Óptica	IRC	K	Equipo	Acabados Int.
OD1	TR Trimless	2	04 400lm	MF MFL 24°	8 80	30 3000 K	N ON/OFF	B Black 03
		3	06 600lm	WF WFL 48°		40 4000 K	D DALI	
		6	12 1200lm					
		9	18 1800lm					
		12	22 2400lm					
OD1	TR	2	04	MF	8	30	N	B





CARACTERÍSTICAS TÉCNICAS

Ópticas

MFL 24°

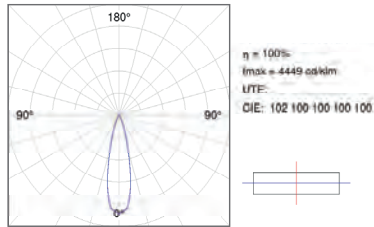

UGR <10
Para 4H, 8H 70/ 50 /20

WFL 48°

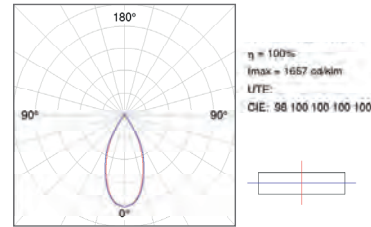

UGR <19
Para 4H, 8H 70/ 50 /20

Datos dimensionales

	2 Modules	3 Modules	6 Modules	9 Modules	12 Modules
XxY	55x74	55x107	55x207	55x307	55x407

Flujo de salida y potencia

OCULT DOWNLIGHT

	K	CRI	2 Modules		3 Modules		6 Modules		9 Modules		12 Modules	
			W	Im Output	W	Im Output	W	Im Output	W	Im Output	W	Im Output
MFL 24°	3000	80	5	360	8	540	14	1080	20	1620	26,7	2160
	4000	80	5	360	8	540	14	1080	20	1620	26,7	2160
WFL 48°	3000	80	5	366	8	549	14	1098	20	1647	26,7	2196
	4000	80	5	366	8	549	14	1098	20	1647	26,7	2196

ACCESORIOS

Refl ctor (2 módulos)



Ref.

ODRF2C
ODRF2M
ODRF2W

Color



Refl ctor (3,6,9,12 módulos)



Ref.

ODRF3C
ODRF3M
ODRF3W

Color



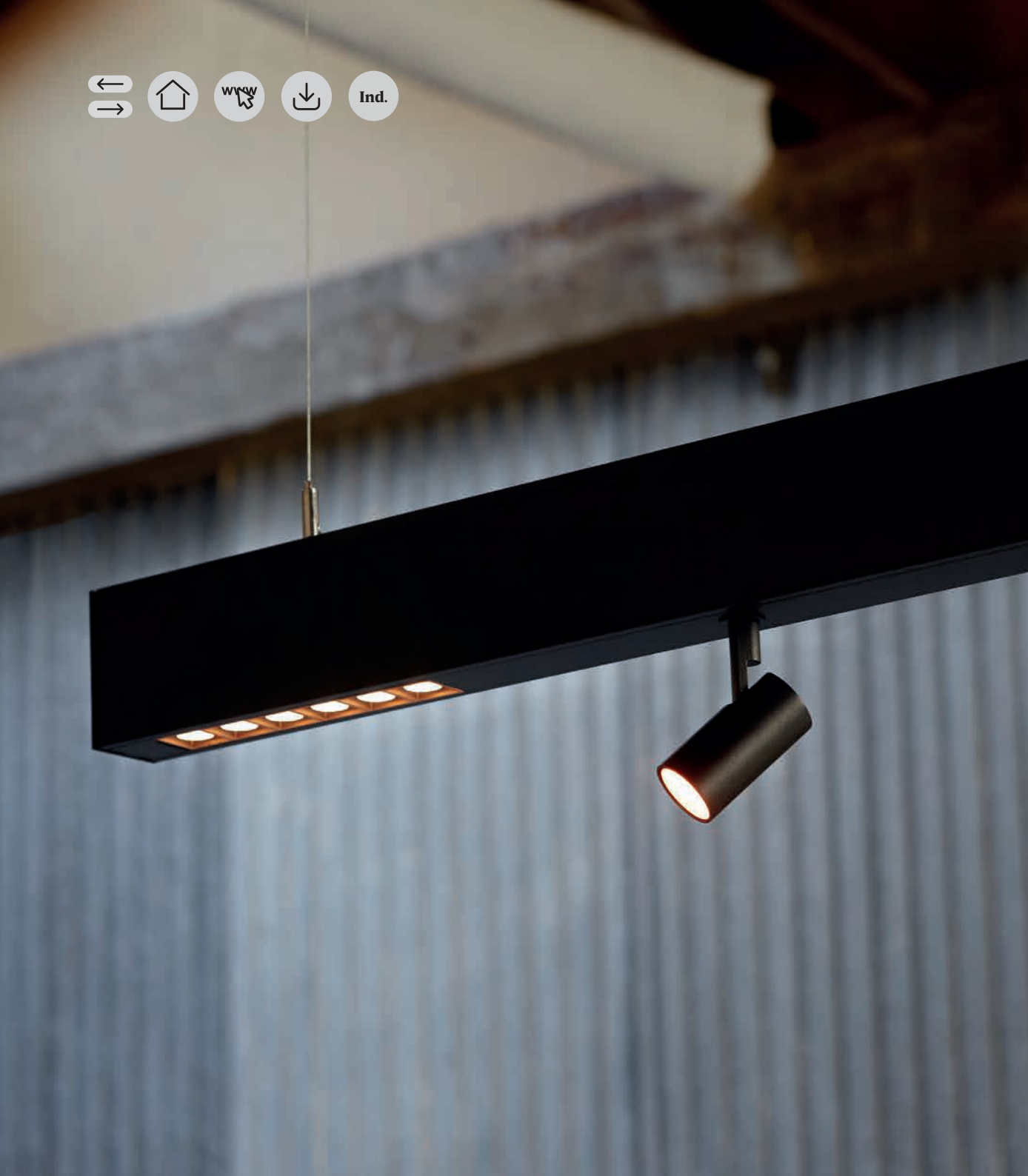

Ocult System



Configuración



Configurador web

1. Instalación

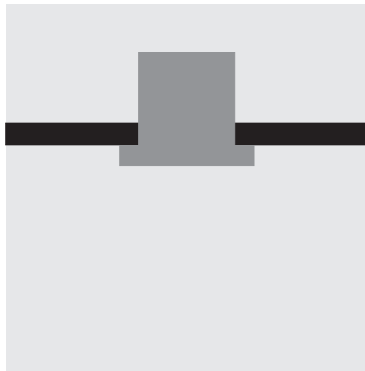

Empotrado

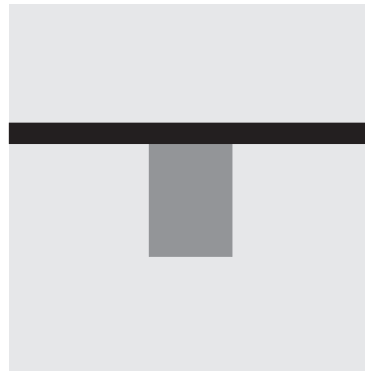

Superficie

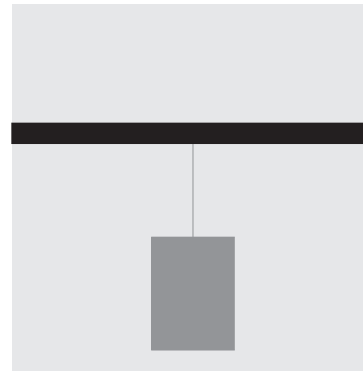

Suspendido

2. Formato



Lineal



Corner

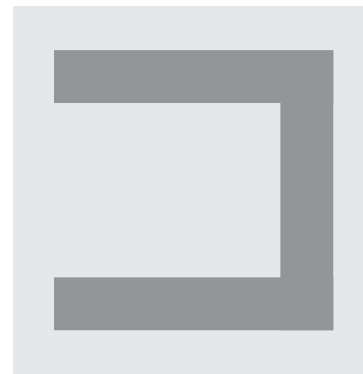

Formato U

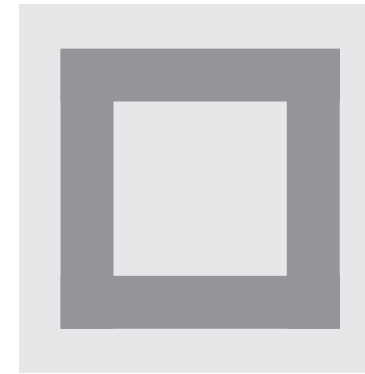

Cuadrado



Personalizado



3. Modulos Lumínicos



Downlight



Proyector

4. Accesorios

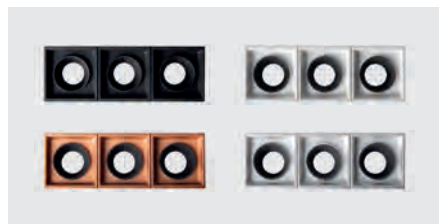

Downlight

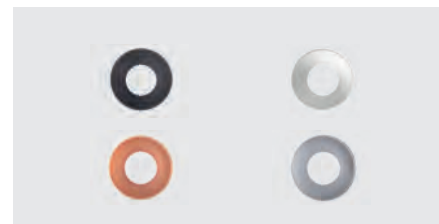

Proyector

5. Solución

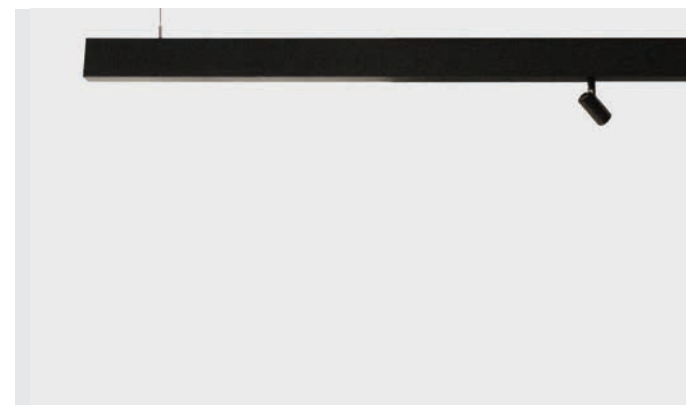



Ocult System Surface Profile

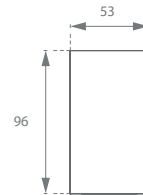

Ocult System Recessed Profile

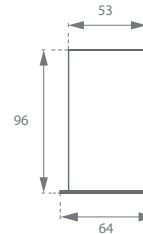

Ocult System Corner

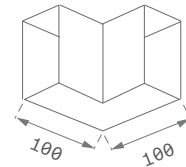

OCULT SYSTEM PROFILE

Familia	Instalación	Tipología	Longitudes	Acabados
OS	SU Surface	PR Profile	500 500mm	B Black O2 W White O2
			600 600mm	
	RE Recessed		700 700mm	
			800 800mm	
	900 900mm			
	1000 1000mm			
	1100 1100mm			
	1200 1200mm			
	1300 1300mm			
	1400 1400mm			
	1500 1500mm			
	1600 1600mm			
1700 1700mm				
1800 1800mm				
1900 1900mm				
2000 2000mm				
OS		CO Cover	200 200mm	B Black O2 W White O2
			300 300mm	
			400 400mm	
			500 500mm	
			600 600mm	
			700 700mm	
			800 800mm	
			900 900mm	
			1000 1000mm	
			OS	
OS	SU Surface RE Recessed	EC End Cover		B Black O2 W White O2
OS		JO Junction		
OS	SU	PR	500	B

● Tapa y accesorios unión incluidos





Ocult System Connectors



OCULT SYSTEM CONNECTORS

Familia	Tipología	Longitudes	Equipo
OS	CTAI Connector	100 100mm	N ON/OFF
		200 200mm	D DALI
		300 300mm	
		400 400mm	
		500 500mm	
		600 600mm	
		700 700mm	
		800 800mm	
		900 900mm	
		1000 1000mm	
		1100 1100mm	
1200 1200mm			
1300 1300mm			
1400 1400mm			
1500 1500mm			

OS	CTAI	100	N
-----------	-------------	------------	----------

Cable de acero regulable



Ref.	Color	h (mm)
SUWIDE1000G	●	1000
SUWIDE4000G	●	4000

Fijación directa

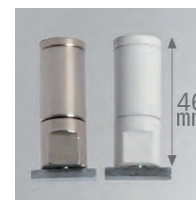

Ref.	Color
SFRG41G	●
SFRG41W	○

Florón decorativo para conexión eléctrica



Ref.	Color
SUCA4000NW	○ Cable transparente 4m (3x1,5mm) incluido.
SUCA4000DW	○ Cable transparente 4m (5x1,5mm) incluido. Para regulación.



Ocult System Downlight
3 Modules 600lm

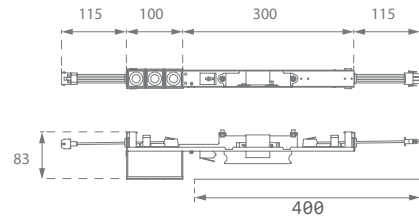
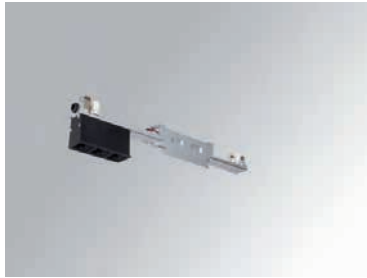

Tapa min. 400mm
* Tapa no incluida

Ocult System Downlight
6 Modules 600lm

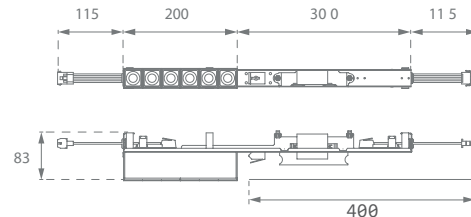

Tapa min. 400mm
* Tapa no incluida

Ocult System Downlight
9 Modules 600lm

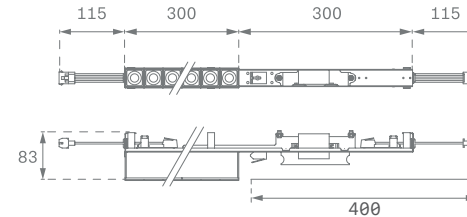
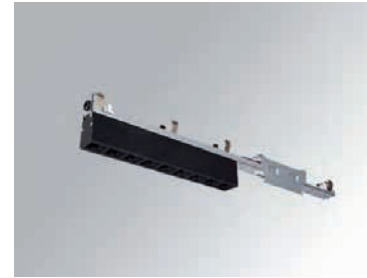

Tapa min. 400mm
* Tapa no incluida

Ocult System Downlight
12 Modules 600lm

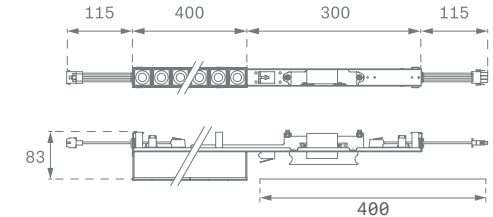

Tapa min. 400mm
* Tapa no incluida

OCULT SYSTEM DOWNLIGHT

Familia	Tipología	Modulos	Lm LED	Óptica	IRC	K	Equipo	Acabados
OS1	DO Downlight	3	06 600lm	MF MFL 24°	8 80	30 3000 K	N ON/OFF	B Black 02
		6	12 1200lm	WF WFL 48°				
		9	18 1800lm					
		12	22 2400lm					
OS1	DO	3	06	MF	8	30	N	B



CARACTERÍSTICAS TÉCNICAS

Ópticas

MFL 24°

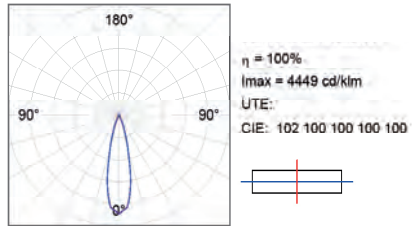

UGR <19
Para 4H, 8H 70/ 50 /20

WFL 48°

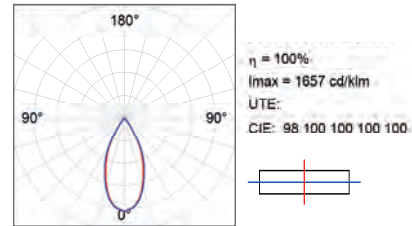

UGR <19
Para 4H, 8H 70/ 50 /20

Flujo de salida y potencia

OCULT SYSTEM DOWNLIGHT

			3 MODULES		6 MODULES		9 MODULES		12 MODULES	
	K	CRI	600lm		1200lm		1800lm		2400lm	
			W	lm Output	W	lm Output	W	lm Output	W	lm Output
MFL 24°	3000	80	7,4	540	13,1	1080	20,8	1620	26,9	2160
	4000	80	7,4	540	13,1	1080	20,8	1620	26,9	2160
WFL 48°	3000	80	7,4	549	13,1	1098	20,8	1647	26,9	2196
	4000	80	7,4	549	13,1	1098	20,8	1647	26,9	2196

ACCESORIOS

Refl ctor (3, 6, 9 ,12 módulos)



Ref.

- ODRF3W
- ODRF3C
- ODRF3M

Color

-
-
-



Ocult System
Spotlight 500lm

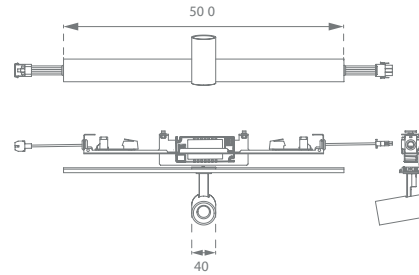

Ocult System
Spotlight 1000lm

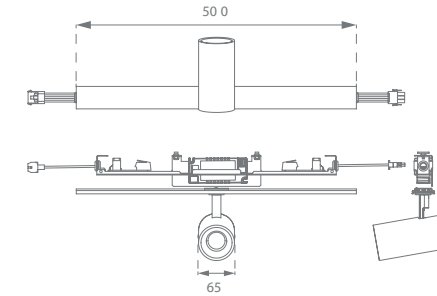

OCULT SYSTEM SPOTLIGHT

Familia	Tipología	Lm LED	Óptica	IRC	K	Equipo	Acabados Acc.	Acabados
OS1	SP Spotlight	05 500lm	SP SP 13°	8 80	30 3000 K 40 4000 K	N ON/OFF D DALI	B Black	B Black 02
			MF MFL 19°					W White 05
			FL FL 26°					
OS1	SP Spotlight	10 1000lm	SS SSP 10°	8 80	30 3000 K 40 4000 K	N ON/OFF D DALI	B Black	B Black 02
								W White 05
OS1	SP Spotlight	10 1000lm	SP SP 17°	8 80	30 3000 K 40 4000 K	N ON/OFF D DALI	B Black	B Black 02
			MF MFL 23°					W White 05
			FL FL 37°					
OS1	SP	05	SP	8	30	N	B	B



CARACTERÍSTICAS TÉCNICAS

Ópticas

SSP 10°

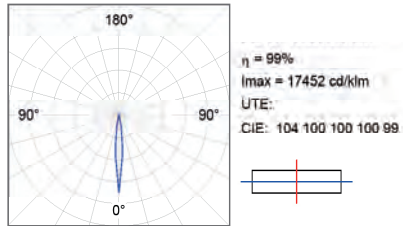

SP 13°-17°

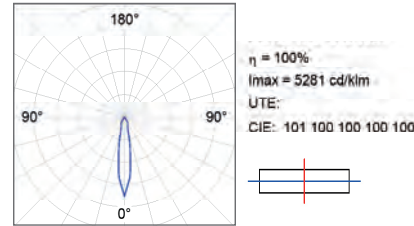

MFL 19-23°

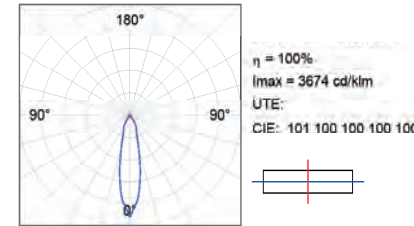

FL 26-37°

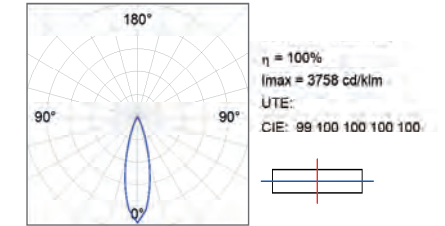

Flujo de salida y potencia

OCULT SYSTEM SPOTLIGHT

	500lm			
	K	CRI	W	lm Output
SP	3000	80	6	314
13°	4000	80	6	339
MFL	3000	80	6	330
19°	4000	80	6	356
FL	3000	80	6	324
26°	4000	80	6	349

	1000lm			
	K	CRI	W	lm Output
SS	3000	80	7,7	498
10°	4000	80	7,7	537
SP	3000	80	7,7	773
17°	4000	80	7,7	819
MFL	3000	80	7,7	806
23°	4000	80	7,7	804
FL	3000	80	7,7	637
37°	4000	80	7,7	738



ACCESORIOS

Difusor transparente



Lm LED	Ref.
500	HSTR25
1000/2000	HSTR50

Refractor para distribución elíptica del flujo luminoso



Lm LED	Ref.
500	HSEL25
1000/2000	HSEL50

Aro Decorativo



Lm LED	Ref.	Color
500	HSRI40W	<input type="radio"/>
500	HSRI40C	<input checked="" type="radio"/>
500	HSRI40M	<input type="radio"/>
1000/2000	HSRI65W	<input type="radio"/>
1000/2000	HSRI65C	<input checked="" type="radio"/>
1000/2000	HSRI65M	<input type="radio"/>



ACCESORIOS

Lente Soft



Lm LED

500
1000/2000

Ref.

[HSSL25](#)
[HSSL50](#)

Rejilla antideslumbrante tipo panel



Lm LED

500
1000/2000

Ref.

[HSH025](#)
[HSH050](#)

Recortador de haz



Lm LED

500
1000/2000

Ref.

[HSCU25](#)
[HSCU50](#)

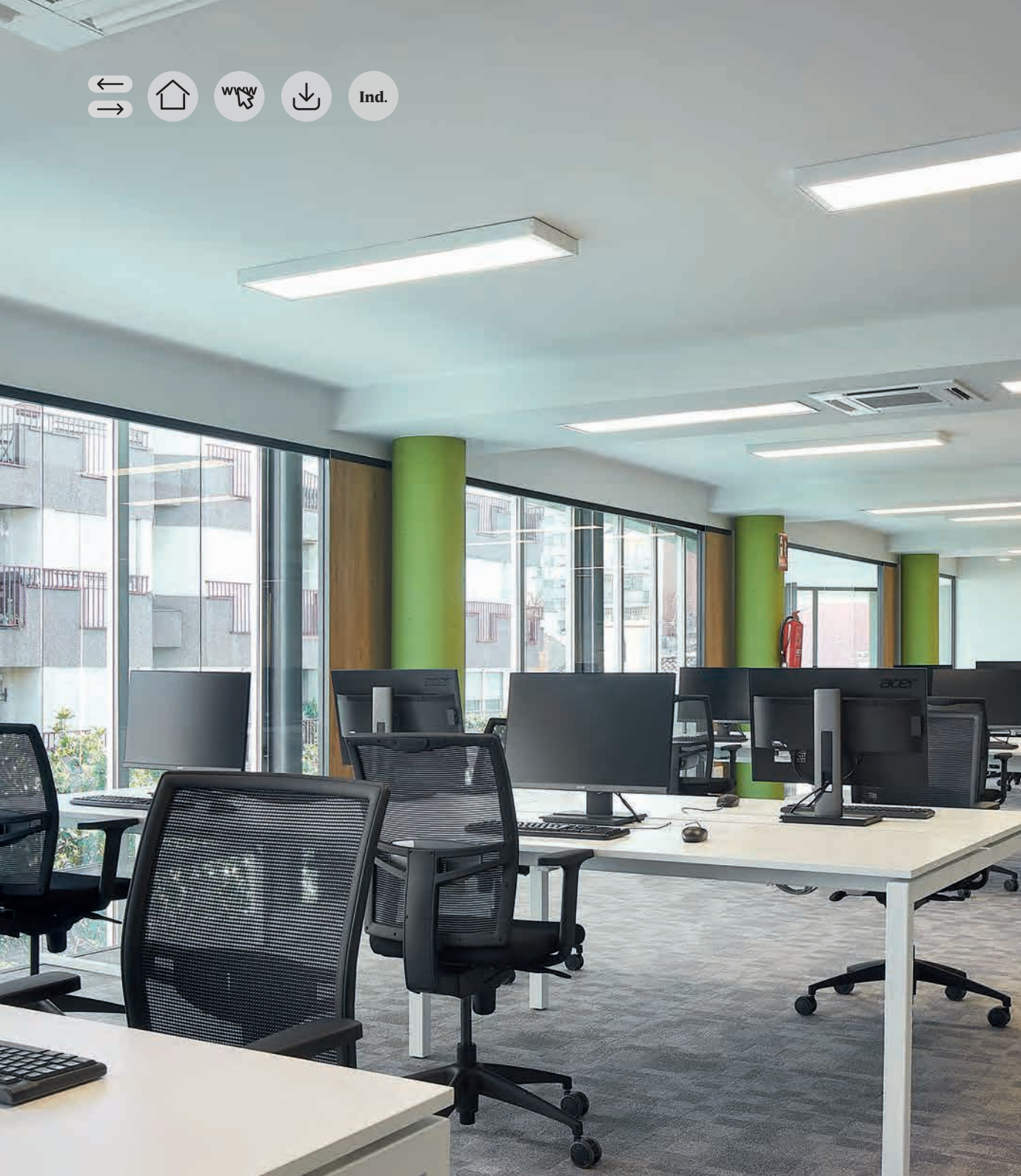

Plat



Plat

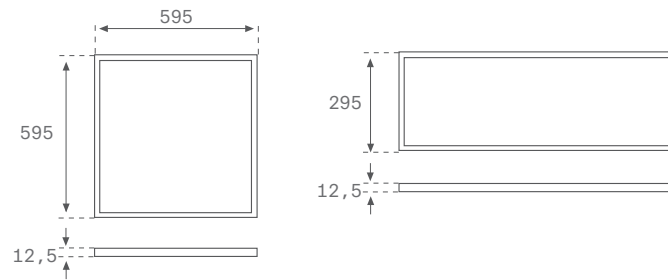

PLAT IP40

Familia	Formato	Lm LED	Óptica	IP	IRC	K	Equipo	Acabados
PL3	060 600x600 120 1200x300	35 4100lm	OP Opal	40 IP40	8 80	30 3000 K	N ON/OFF D DALI	W White 06
				54 IP54		40 4000 K		
				65 IP65		8 80		
			PR Prismatic		9 90	30 3000 K 40 4000 K		
PL3	060	30	OP	40		30	N	W

PLAT TUNABLE WHITE

Familia	Formato	Lm	Óptica	IP	IRC	K	Equipo	Acabados
PL3	060 600x600	35 3500lm	OP Opal	40 IP40	8 80	TW Tunable White	D DALI	W White 06
PL3	060	35	OP	40	8	TW	D	W

PLAT TECH

Familia	Formato	Lm	Óptica	IP	IRC	K	Equipo	Acabados
PT1	060 600x600	40 4000lm	TE Tech	40 IP40	9 90	30 3000 K 40 4000 K	N ON/OFF D DALI	W White 06
PL3	060	40	TE	40	9	TW	D	W



CARACTERÍSTICAS TÉCNICAS

Ópticas

OP

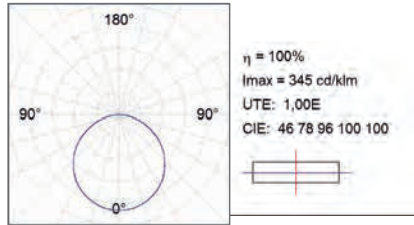

○ Blanco texturizado

PR

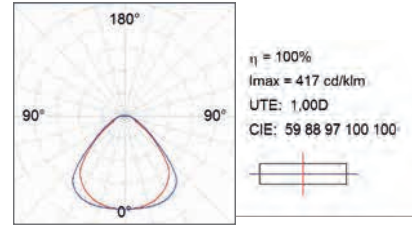

UGR <19
Para 4H, 8H 70/ 50 /20

TE

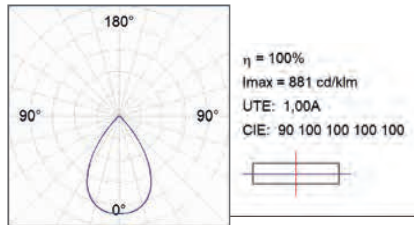

ACCESORIOS

Kit de suspensión



Ref.	h(m)
PLSUWI1500	max. 1,5m

Flujo de salida y potencia

PLAT

	600x600				1200x300			
	K	CRI	W	lm Output	K	CRI	W	lm Output
OP	3000	80	31	3607	3000	80	31	3607
	4000	80	31	3819	4000	80	31	3819
	TW	80	36	4495				
PR	3000	80	31	3395	3000	80	31	3395
		90	31	2900		90	30	2800
	3500	80	30	3500	3500	80	30	3500
		90	-	-		90	-	-
	4000	80	31	3607	4000	80	31	3607
		90	30	3100		90	30	3000
TE	3000	90	31	3262				
	4000	90	31	3413				

Marco para adosar a techo PLAT



Ref.	Color	mm
PLSFFR060	○	600x600x59
PLSFFR120	○	1200x300x59

Marco para empotrar PLAT



Ref.	Color	mm
PLREFR060	○	600x600x59
PLREFR120	○	1200x300x59



Puzzle

Puzzle
Individual

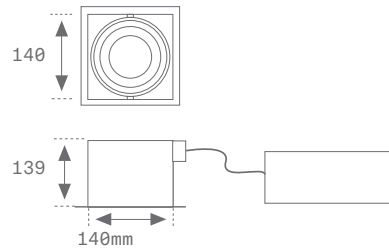

PUZZLE INDIVIDUAL

Familia	Instalación	Formato	Lm LED	Óptica	IRC	K	Equipo	Acabados
PU2	RE Recessed	1 Individual	15 1400lm 25 2500lm 35 3500lm	MF MFL 26° FL FL 37°	8 80	30 3000 K 40 4000 K	N ON/OFF	W White 02 B Black 02
PU2	RE	1	15	MF	8	30	N	W

CARACTERÍSTICAS TÉCNICAS

Ópticas

MFL 26°

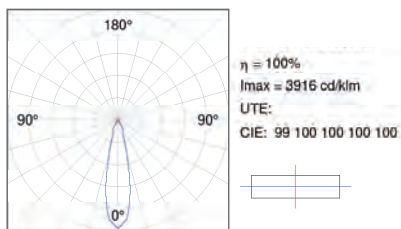

FL 37°

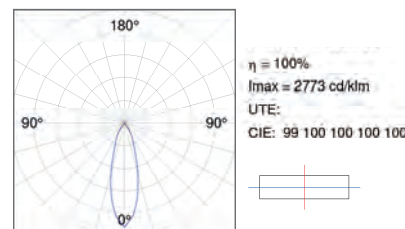

Flujo de salida y potencia

PUZZLE INDIVIDUAL

	K	CRI	1x1400lm		1x2500lm		1x3500lm	
			W	lm Output	W	lm Output	W	lm Output
MFL 26°	3000	80	9,9	1207	19,2	2263	31,4	3103
	4000	80	9,9	1257	19,2	2357	31,4	3232
FL 37°	3000	80	9,9	1168	19,2	2190	31,4	3004
	4000	80	9,9	1217	19,2	2281	31,4	3129



Puzzle
Double

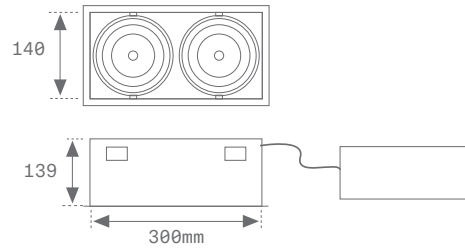

PUZZLE DOUBLE

Familia	Instalación	Formato	Lm LED	Óptica	IRC	K	Equipo	Acabados
PU2	RE Recessed	2 Double	25 2500lm 35 3500lm	MF MFL 26° FL FL 37°	8 80	30 3000 K 40 4000 K	N ON/OFF	W White 02 B Black 02
PU2	RE	2	25	MF	8	30	N	W

CARACTERÍSTICAS TÉCNICAS

Ópticas

MFL 28°

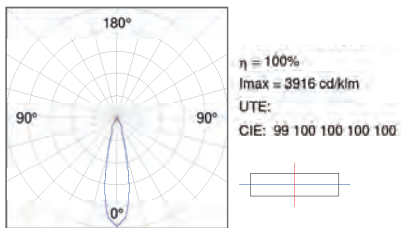

FL 38°

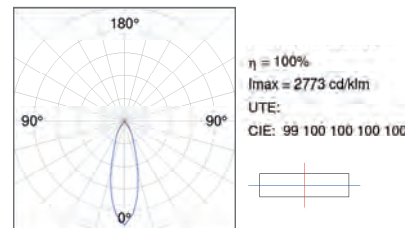

Flujo de salida y potencia

PUZZLE DOUBLE

	K	CRI	2x2500lm		2x3500lm	
			W	lm Output	W	lm Output
MFL	3000	80	38,1	4525	66,6	6205
26°	4000	80	38,1	4714	66,6	6464
FL	3000	80	38,1	4380	66,6	6008
37°	4000	80	38,1	4562	66,6	6258



Puzzle
Triple

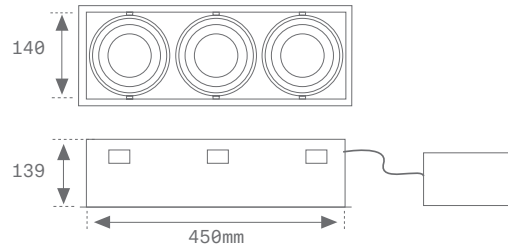

PUZZLE TRIPLE

Familia	Instalación	Formato	Lm LED	Óptica	IRC	K	Equipo	Acabados
PU2	RE Recessed	3 Triple	25 2500lm 35 3500lm	MF MFL 26° FL FL 37°	8 80	30 3000 K 40 4000 K	N ON/OFF	W White 02 B Black 02
PU2	RE	3	25	MF	8	30	N	W

CARACTERÍSTICAS TÉCNICAS

Ópticas

MFL 28°

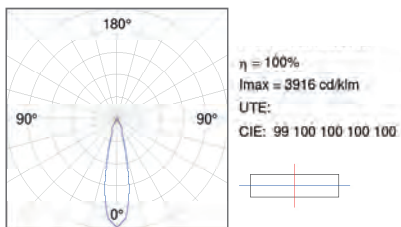

FL 38°

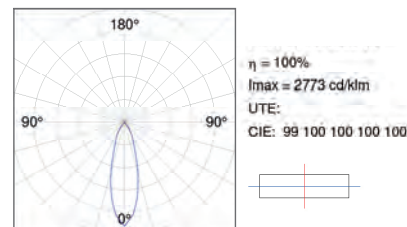

Flujo de salida y potencia

PUZZLE TRIPLE

			3x2500lm		3x3500lm	
	K	CRI	W	lm Output	W	lm Output
MFL	3000	80	57	6788	99,7	9308
	4000	80	57	7071	99,7	9696
FL	3000	80	57	6570	99,7	9012
	4000	80	57	6843	99,7	9387



Puzzle Recessed



Marcos embellecedores de empotrar para módulos Puzzle (RE)

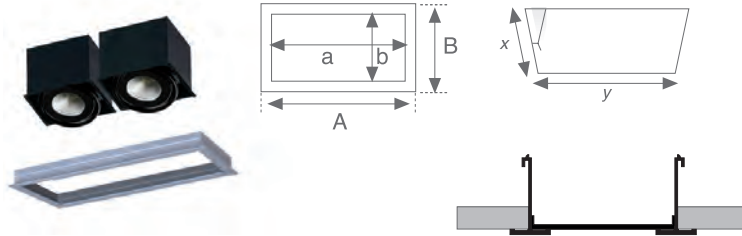

PUZZLE FRAMES RECESSED

Familia	Instalación	Tipo	Acabados
PU	RE Recessed	FR Frame	W White 04
		1	
		2	
		3	
		4	
		5	
		6	
		9	
PU	RE	FR	1 W

Puzzle Trimless



Marcos ocultos de empotrar para módulos Puzzle (TR)

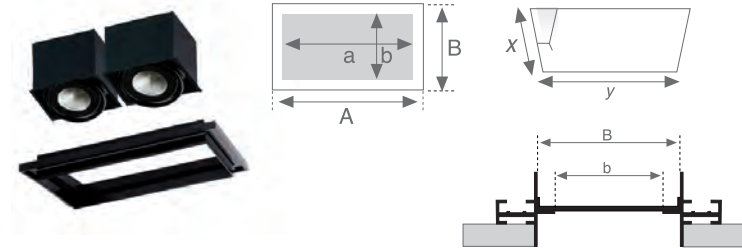

PUZZLE FRAMES TRIMLESS

Familia	Instalación	Tipo	Acabados
PU	TR Recessed	FR Frame	W White 04 B Black 04
		1	
		2	
		3	
		4	
		5	
		6	
		9	
PU	TR	FR	1 W

Datos Dimensionales

Kind	A x B	a x b	x x y	Module	Combination
1	186x186	142x142	174x174	A	1A
2	344x190	300x146	332x178	B	2A/B
3	494x190	450x146	482x178	C	3A/A+B/C
4	654x190	610x146	642x178		A+C/B+B/2A+B/4A
5	959x190	915x146	974x178		3B/2C
6	1264x190	1220x146	1252x178		2C+1B
9	344x344	300x300	332x332		2B

ACCESORIOS

Módulo A ciego

	Ref.	Color	Lmm	Kg
	PUCOAB	●	160	0,1
	PUCOAW	○	160	0,1

Unión codo 90° (uniones incluidas)

	Ref.	Color
	PUTRFRCB	●
	PUTRFRCW	○

Fijación intermedia para marcos ocultos (2 unidades por referencia)

	Ref.
	PUTRFRJ0

Módulo B ciego

	Ref.	Color	Lmm	Kg
	PUCOBB	●	320	0,2
	PUCOBW	○	320	0,2

Extremo de marco oculto "U" (1 unidad por referencia, uniones incluidas)

	Ref.	Color
	PUTRFRENB	●
	PUTRFRENW	○

Perfil ma co oculto (1 unidad por referencia)

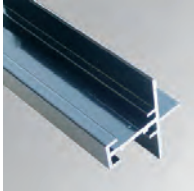
	Ref.	Color
	PUTRFRPR1000B	●
	PUTRFRPR1000W	○
	PUTRFRPR3000B	●
	PUTRFRPR3000W	○



Quiet



Quiet
Baffle Fil 4

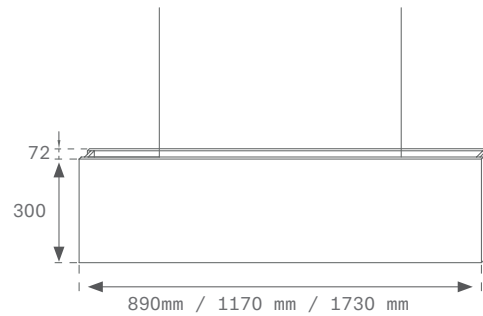

QUIET BAFFLE FIL 45

Familia	Formato	Lm LED/m	Óptica	IRC	K	Equipo
QBF41	084 890mm	M0 2320lm	PR Opal Comfort	8 80	30 3000 K	N ON/OFF D DALI
	112 1170mm				40 4000 K	
	168 1730mm					
QBF41	084	M0	PR	8	30	N

CARACTERÍSTICAS TÉCNICAS

Ópticas

PR

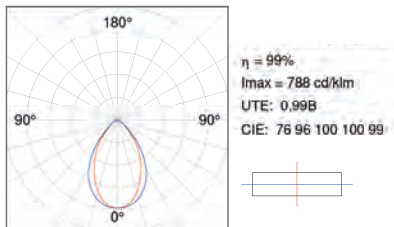

Flujo de salida y potencia

QUIET BAFFLE FIL 45

	K	CRI	840mm		1120mm		1680mm	
			W	lm Output	W	lm Output	W	lm Output
PR	3000	80	15,5	1441	20,9	1922	30,8	2881
	4000	80	15,5	1512	20,9	2017	30,8	3026



Quiet
Round Kombic 100

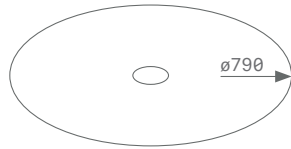

Quiet
Round Kombic 150

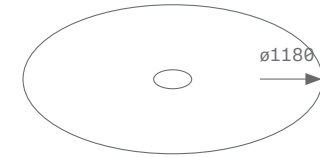

QUIET ROUND S KOMBIC 100

Familia	Lm LED	Óptica	IRC	K	Equipo
QRK11	20 2000lm	OP Opal WF WFL 50°	8 80	30 3000 K 40 4000 K	N ON/OFF D DALI

QRK11	20	OP	8	30	N
--------------	-----------	-----------	----------	-----------	----------

QUIET ROUND L KOMBIC 150

Familia	Lm LED	Óptica	IRC	K	Equipo
QRK21	30 3000lm	OP Opal WF WFL 50°	8 80	30 3000 K 40 4000 K	N ON/OFF D DALI

QRK21	30	OP	8	30	N
--------------	-----------	-----------	----------	-----------	----------



CARACTERÍSTICAS TÉCNICAS

Ópticas

OP

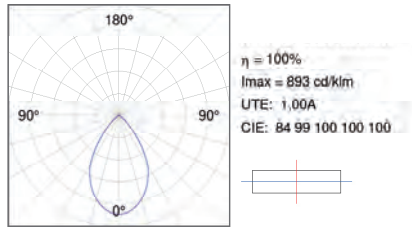

WFL 50°

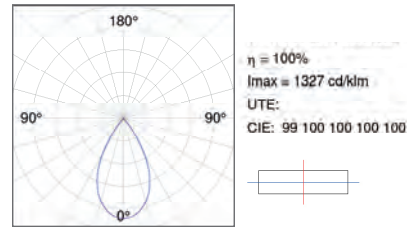

OP

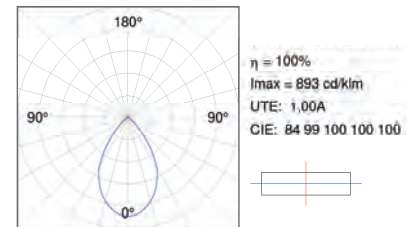

WFL 50°

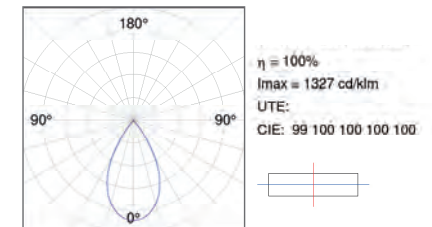

Flujo de salida y potencia

KOMBIC DOWNLIGHT 100 OPAL

	2000lm			
	K	CRI	W	lm Output
BK	3000	80	13	1460
	4000	80	13	1547
MA	3000	80	13	1392
	4000	80	13	1474
WH	3000	80	13	1454
	4000	80	13	1541

KOMBIC DOWNLIGHT 100 OPTIC

	2000lm			
	K	CRI	W	lm Output
BK	3000	80	14	1205
	4000	80	14	1277
MA	3000	80	14	1268
	4000	80	14	1343
WH	3000	80	14	1275
	4000	80	14	1351

KOMBIC DOWNLIGHT 150 OPAL

	3000lm			
	K	CRI	W	lm Output
BR	3000	80	19	2096
	4000	80	19	2184
MA	3000	80	19	2010
	4000	80	19	2094
WH	3000	80	19	2074
	4000	80	19	2161

KOMBIC DOWNLIGHT 150 OPTIC

	3000lm			
	K	CRI	W	lm Output
BK	3000	80	19	1613
	4000	80	19	1680
MA	3000	80	19	1618
	4000	80	19	1685
WH	3000	80	19	1677
	4000	80	19	1737

Dimensiones de corte

	Kombic 100	Kombic 150
∅	D95mm	D145mm



Quiet
Square Ocult

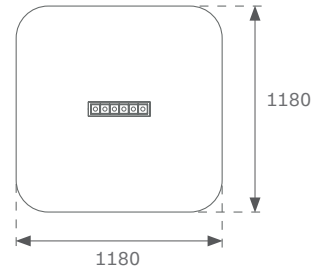

Quiet
Rectangle Ocult

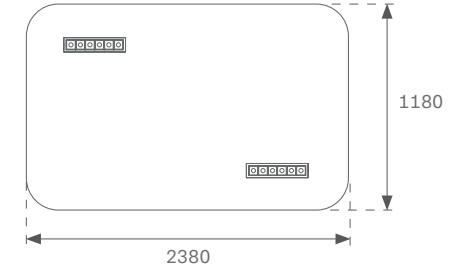

QUIET SQUARE OCULT

Familia	Módulos	Lm LED	Óptica	IRC	K	Equipo
QSOD1	06	12 1200lm	MF MFL 24°	8 80	30 3000 K	N ON/OFF
	09	18 1800lm	WF WFL 48°		40 4000 K	D DALI
QSOD1	06	12	MF	8	30	N

QUIET RECTANGLE OCULT

Familia	Módulos	Lm LED	Óptica	IRC	K	Equipo
QR0D1	26 2x6	24 2400lm	MF MFL 24°	8 80	30 3000 K	N ON/OFF
	29 2x9	36 3600lm	WF WFL 48°		40 4000 K	D DALI
QR0D1	26	24	MF	8	30	N



CARACTERÍSTICAS TÉCNICAS

Ópticas

MFL 24°

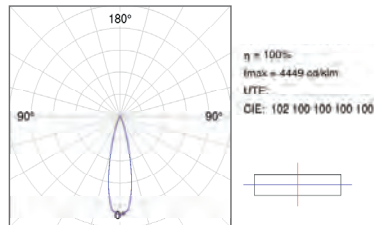

UGR <10
Para 4H, 8H 70/ 50 /20

WFL 48°

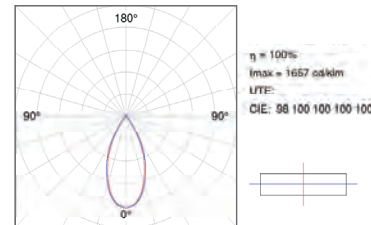

UGR <19
Para 4H, 8H 70/ 50 /20

Datos dimensionales

	6 Modules	9 Modules
XxY	43x207	43x307



Flujo de salida y potencia

QUIET SQUARE OCULT

	K	CRI	6 Modules		9 Modules	
			W	Im Output	W	Im Output
MFL 24°	3000	80	12	1080	18	1620
	4000	80	12	1080	18	1620
WFL 48°	3000	80	12	1098	18	1647
	4000	80	12	1098	18	1647

QUIET RECTANGLE OCULT

	K	CRI	6 Modules		9 Modules	
			W	Im Output	W	Im Output
MFL 24°	3000	80	12	2160	18	3240
	4000	80	12	2160	18	3240
WFL 48°	3000	80	12	2196	18	3294
	4000	80	12	2196	18	3294

ACCESORIOS

Refl ctor (3,6,9,12 módulos)



Ref.

- ODRF3C
- ODRF3M
- ODRF3W

Color

-
-
-



Quiet Hexagonal Ocult

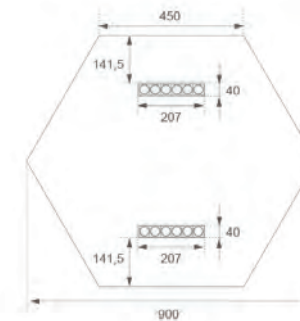
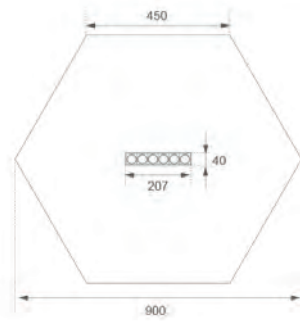

QUIET HEXAGONAL OCULT

Familia	Formato	Lm LED	Óptica	IRC	K	Equipo
QHOD1	06 1x6	12 1200lm	MF MFL 24°	8 80	30 3000 K	N ON/OFF
	12 2x6	24 2400lm	WF WFL 48°		40 4000 K	D DALI

QHOD1	06	12	PR	8	30	N
-------	----	----	----	---	----	---

CARACTERÍSTICAS TÉCNICAS

Ópticas

MFL 24°

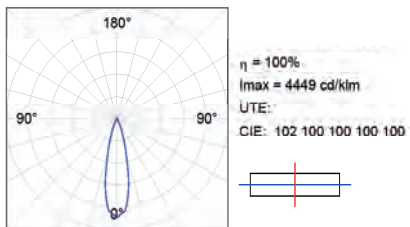

UGR <19
Para 4H, 8H 70/ 50 /20

WFL 48°

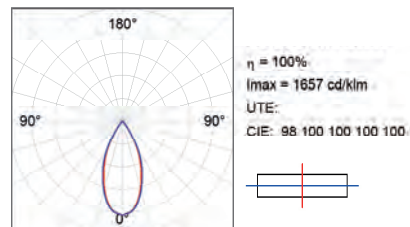

UGR <19
Para 4H, 8H 70/ 50 /20

Flujo de salida y potencia

QUIET HEXAGONAL

	K	CRI	1XOCULT6		2XOCULT6	
			W	lm Output	W	lm Output
MFL	3000	80	14	1080	28	2160
	4000	80	14	1080	28	2160
WFL	3000	80	14	1098	28	2196
	4000	80	14	1098	28	2196



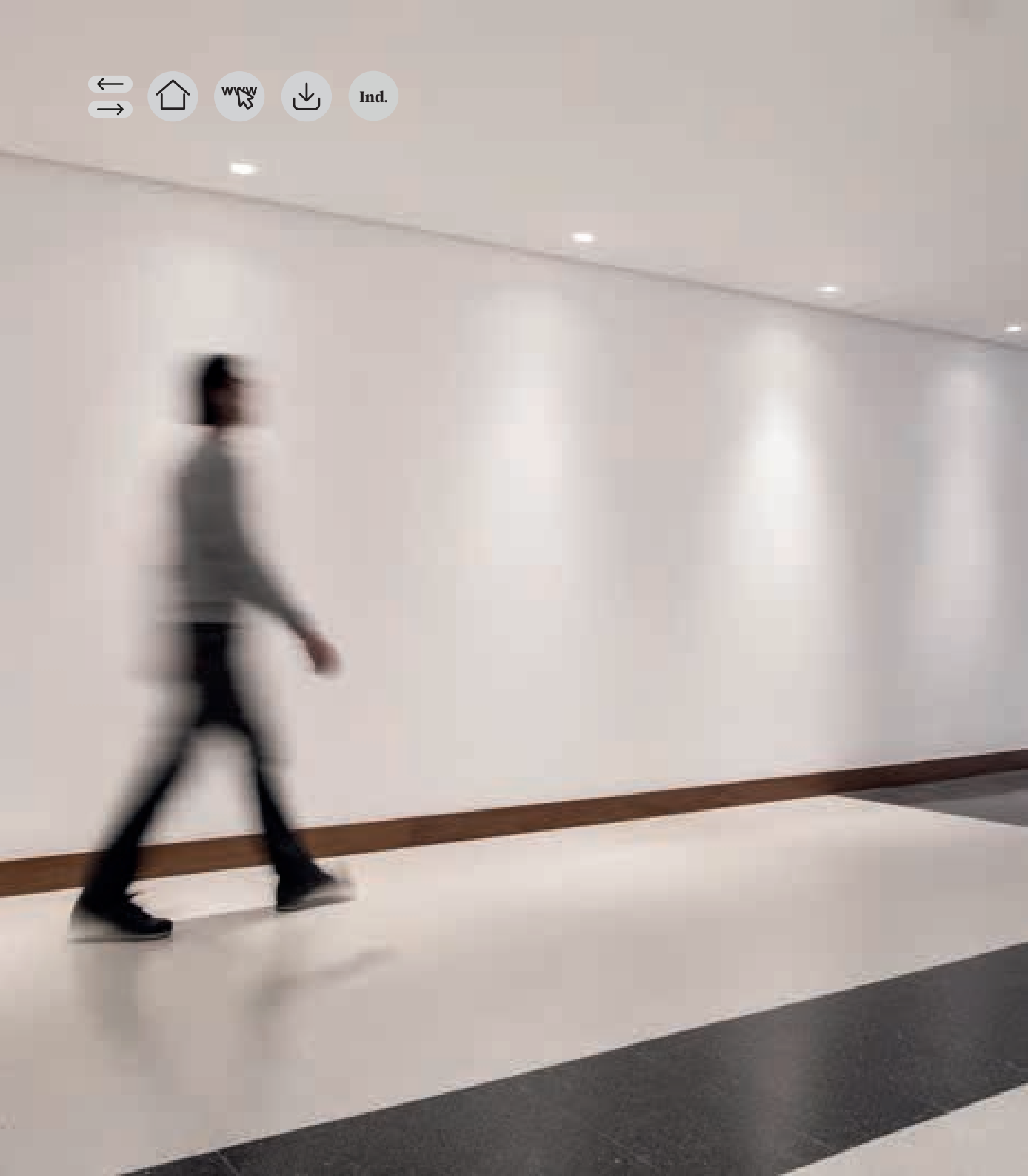

Ring

Ring 90
Round

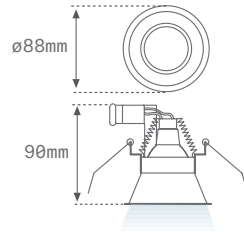

Ring 90
Square

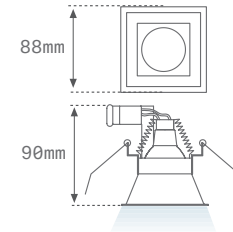

Ring 40
Round

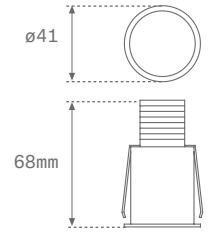

RING

Familia	Formato	Instalación	Lm LED	Óptica	IRC	K	Equipo	Acabados
RI1	90 88mm	RD Round SQ Square	10 1300	MF MFL 28°	8 80	30 3000 K	T TRIAC	W White 02
	40 40mm	RD Round	02 150	SP SP 10°	9 90	27 2700 K 30 3000 K	N ON/OFF	W White 02 B Black 02
RI1	90	RD	10	MF	8	30	T	W

CARACTERÍSTICAS TÉCNICAS

Ópticas

ROUND

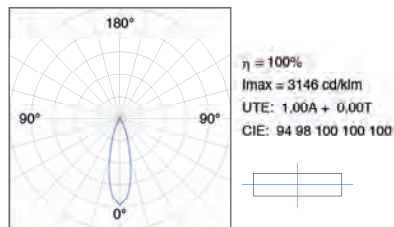

SQUARE

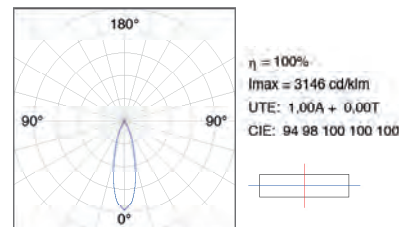

Flujo de salida y potencia

RING 90

	1300lm			
	K	CRI	W	lm Output
MF 28°	3000	80	11,8	971

RING 40

	150lm			
	K	CRI	W	lm Output
WH	2700	90	3,1	114
	3000	90	3,1	131
BK	2700	90	3,1	105
	3000	90	3,1	121



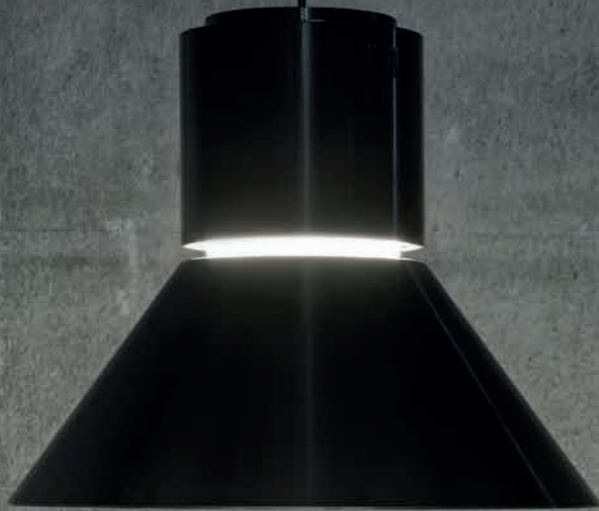

Stormbell



Stormbell

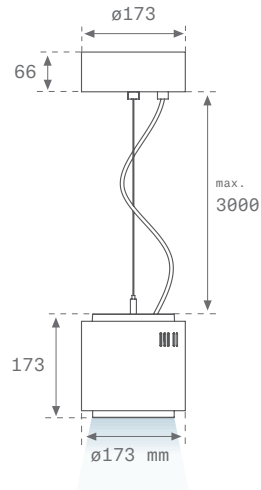

Stormbell
Deco

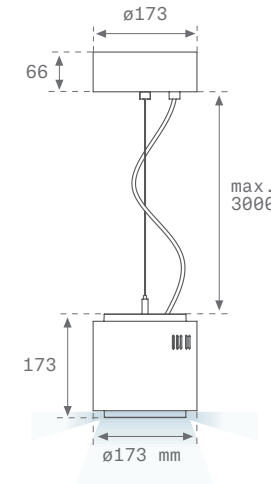

STORMBELL

Familia	Formato	Lm LED	Óptica	IRC	K	Equipo	Acabados Int.	Acabados				
ST1	170 ø173mm	30	3000lm	FL FL 39°	8	80	30	3000 K	N ON/OFF	B Black 04	W White 04	
		50	5000lm	WF WFL 57°			40	4000 K		O Opal		
		80	8000lm									
ST1	170	30	FL	8	30	N	B	W				

● Reflector obligatorio para utilizar accesorios





CARACTERÍSTICAS TÉCNICAS

Ópticas

FL 39°

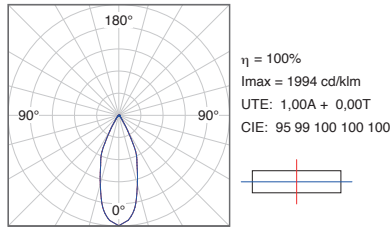

WFL 57°

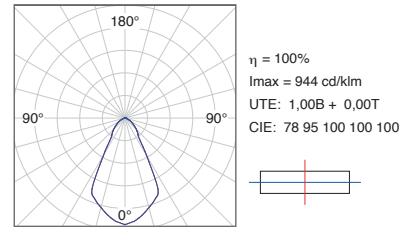

DECO FL 39°

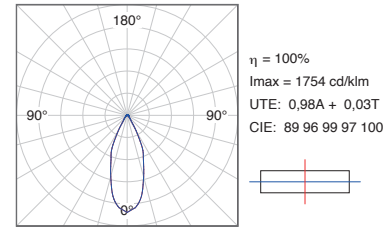

DECO WFL 57°

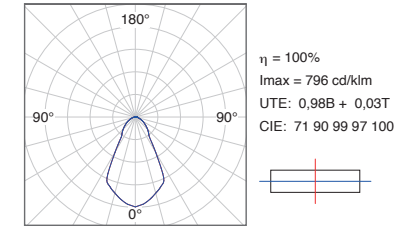

Flujo de salida y potencia

STORMBELL

	K	CRI	3000lm		5000lm		8000lm	
			W	lm Output	W	lm Output	W	lm Output
FL	3000	80	26,3	2402	47,4	3690	68	4884
39°	4000	80	26,3	2468	47,4	3793	68	5000
WFL	3000	80	26,3	2492	47,4	3795	68	5147
57°	4000	80	26,3	2561	47,4	3900	68	5271

STORMBELL DECO

	K	CRI	3000lm		5000lm		8000lm	
			W	lm Output	W	lm Output	W	lm Output
FL	3000	80	26,3	2648	47,4	4152	68	5517
39°	4000	80	26,3	2722	47,4	4267	68	5649
WFL	3000	80	26,3	2985	47,4	4707	68	6371
57°	4000	80	26,3	3068	47,4	4837	68	6524

REFLECTORES

Reflector blanco



Ref.
STBE420W

hmm 173
ø4mm 420

Pict.
850° PC

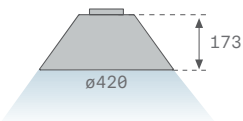

Reflector glaseado



Ref.
STBE420P

hmm 173
ø4mm 420

Pict.
850° PC

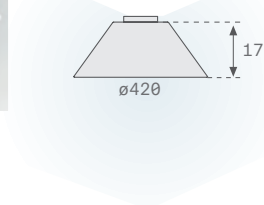

Reflector negro



Ref.
STBE420B

hmm 173
ø4mm 420

Pict.
850° PC

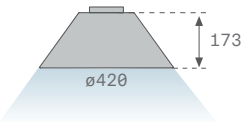

ACCESORIOS

Rejilla antideslumbrante tipo panal de abeja

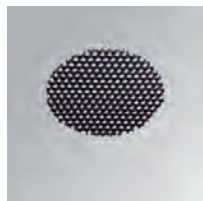

Ref.
STH0102B

ømm 102

Cierre de cristal opal



Ref.
ST1020P

ømm 102

Cierre de cristal transparente



Ref.
ST102TR

ømm 102



Stormbell 80



Stormbell 80
Suspended Recessed

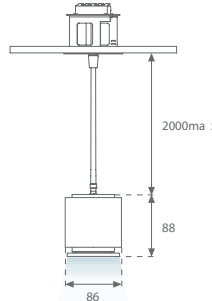

Stormbell 80
Suspended Surface

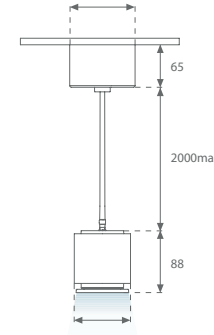

NS Stormbell 80
Suspended Track

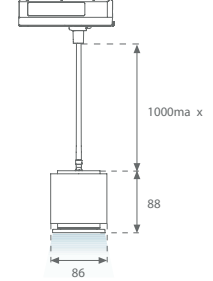

STORMBELL 80 WB

Familia	Instalación	Lm LED	Óptica	IRC	K	Equipo	Acabados Aro	Acabados
ST18	SE Sus. Rec.	LO 1500lm	SP SP 15°	9 90	27 2700 K	N ON/OFF D DALI	OP Opal B Black ● P.405	W White B Black 1 Materiality
	SS Sus. Sur.		MF MFL 23°		30 3000 K			
	ST Sus. Track		WF WFL 57°		40 4000 K			
					WB3 WB 3000 K WB4 WB 4000 K			
ST18	SE	LO	SP	9	27	N	OP	W

STORMBELL 80 TW

Familia	Instalación	Lm LED	Óptica	IRC	K	Equipo	Acabados Aro	Acabados
ST18	SE Sus. Rec.	LO 1500lm	SP SP 25°	9 90	TW Tunable White	D DALI	OP Opal B Black ● P.405	W White B Black 1 Materiality
	SS Sus. Sur.		MF MFL 23°					
	ST Sus. Track		WF WFL 57°					
ST18	SE	LO	SP	9	TW	D	OP	W

● **Accesorio reflector obligatorio**



CARACTERÍSTICAS TÉCNICAS

Ópticas

SP

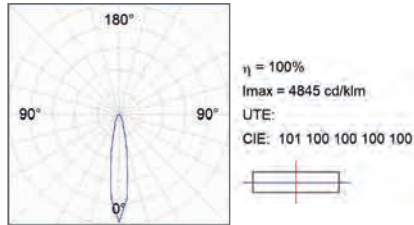

MFL

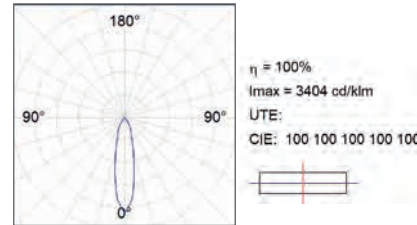

WFL

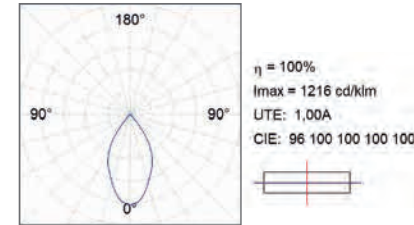

Flujo de salida y potencia

STORMBELL 80

	K	CRI	SU RE		SU SF		SUT	
			W	lm Output	W	lm Output	W	lm Output
SP	2700	90	14,4	1286	14,4	1286	14,4	1286
	3000	90	14,4	1342	14,4	1342	14,4	1342
	4000	90	14,4	1426	14,4	1426	14,4	1426
	3000 WB	98	14,4	1060	14,4	1060	14,4	1060
	4000 WB	98	14,4	1130	14,4	1130	14,4	1130
MFL	2700	90	14,4	1312	14,4	1312	14,4	1312
	3000	90	14,4	1369	14,4	1369	14,4	1369
	4000	90	14,4	1460	14,4	1460	14,4	1460
	3000 WB	98	14,4	1085	14,4	1085	14,4	1085
	4000 WB	98	14,4	1156	14,4	1156	14,4	1156
WFL	2700	90	14,4	1326	14,4	1326	14,4	1326
	3000	90	14,4	1384	14,4	1384	14,4	1384
	4000	90	14,4	1474	14,4	1474	14,4	1474
	3000 WB	98	14,4	1097	14,4	1097	14,4	1097
	4000 WB	98	14,4	1160	14,4	1160	14,4	1160



ACCESORIOS

Reflector 80x50



Ref.
S8BE86W
S8BE86B
S8BE86B1

Color
○
●
● ● ● ● ● ● ● ●

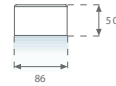

Reflector 161x150



Ref.
S8BE161W
S8BE161B
S8BE161B1

Color
○
●
● ● ● ● ● ● ● ●

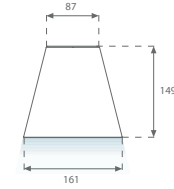

Reflector 227x89



Ref.
S8BE227W
S8BE227B
S8BE227B1

Color
○
●
● ● ● ● ● ● ● ●

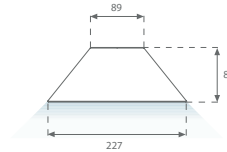

Reflector 363x60



Ref.
S8BE363W
S8BE363B
S8BE363B1
S8BE363PT
S8BE363CK

Color
○
●
● ● ● ● ● ● ● ● ● ●

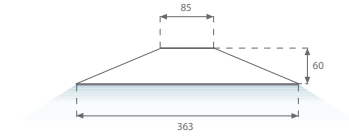

Paletas Materiality: 1





Track

Track 48V

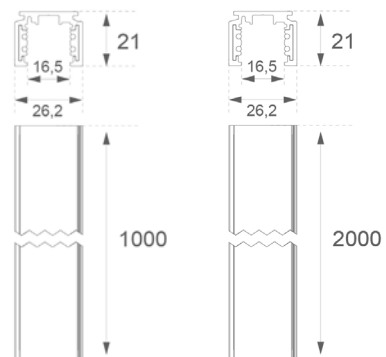

TRACK 48V

Familia	Instalación	Tipología	Longitud	Equipo	Acabados
TL	SU Surface	PR Profile	1000 1000mm 2000 2000mm	D DALI	W White 06 B Black 01
TL	SU	PR	1000	D	W

ACCESORIOS













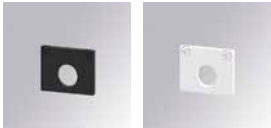
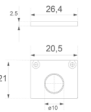

DRIVER

Familia	Tipología	IP	W	Voltaje	Equipo
TL	DRV Driver	20 IP 20	70 70W 150 150W	48 48V	N ON/OFF
TL	DRV	20	70	48	N

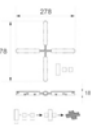

● Se recomienda no sobrepasar el 85% de la capacidad del driver.

TRACK 48V ACCESORIES

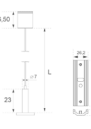
Familia	Instalación	Tipología		Longitud	Equipo	Acabados
TLA	SU Surface	A	Alimentation	 	DN DALI ON-OFF	W White 06 B Black 01
		EC	End cover	 		
		ECC	End cover cable	 		
		UI	Unión	 		
		UL	Connector "L"	 		
		UXJ	Connector "X"	 		
		MJ	Mechanical connection	 	1500 1500mm 3000 3000mm	
		WI1500 WI3000	Suspension wire	 		
TLA	SU	A		1500	D	W

Track 230V







THREE PHASE TRACK

Familia	Instalación	Tipología	Longitud	Equipo	Acabados
TK	RE Recessed	PR Profile	1000 1000mm	DN DALI-ON/OFF	W White
			2000 2000mm		
			3000 3000mm		
	SU Suspended	PR Profile	1000 1000mm	DN DALI-ON/OFF	W White 06
			2000 2000mm		B Black 01
			3000 3000mm		G Grey
TK	RE	PR	1000	DN	W

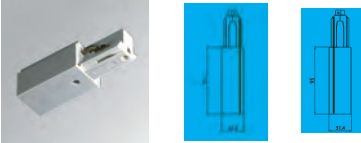

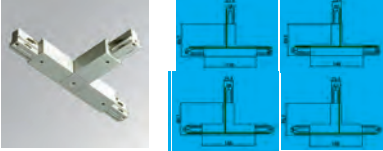
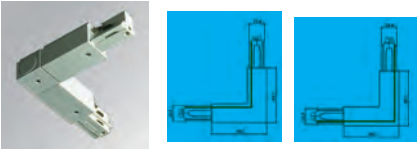

ACCESORIOS

THREE PHASE TRACK ACCESSORIES

Familia	Instalación	Tipología	Definició	Equipo	Acabados		
TKA		AR Mains Supply Right		DN DALI-ON/OFF	W White		
		AL Mains Supply Left			B Black	G Grey	
		AI Intermediate Joint		DN DALI-ON/OFF	W White	B Black	G Grey
		TR T Junction Right		O Outside I Inner	DN DALI-ON/OFF	W White	
		TL T Junction Left				B Black	G Grey
		LI Inner corner					
	LO Outside corner						
	XJ X Joint						
	JU Junction						
	JF Flexible Junction						
TKA		AR		DN	W		

ACCESORIOS

THREE PHASE TRACK ACCESSORIES

Familia	Instalación	Tipología	Definición	Equipo	Acabados
TKA		EC End Cover			W White B Black G Grey
		CX X Cover			
		CO Decorative Cover (Recessed)			W White B Black G Grey
		SUSSU Suspension Support SRSU Surface Support			W White B Black G Grey
		WI Suspesion Wire		3000 3000mm	
		RG Rigid		1000 1000mm	W White
TKA		EC			W

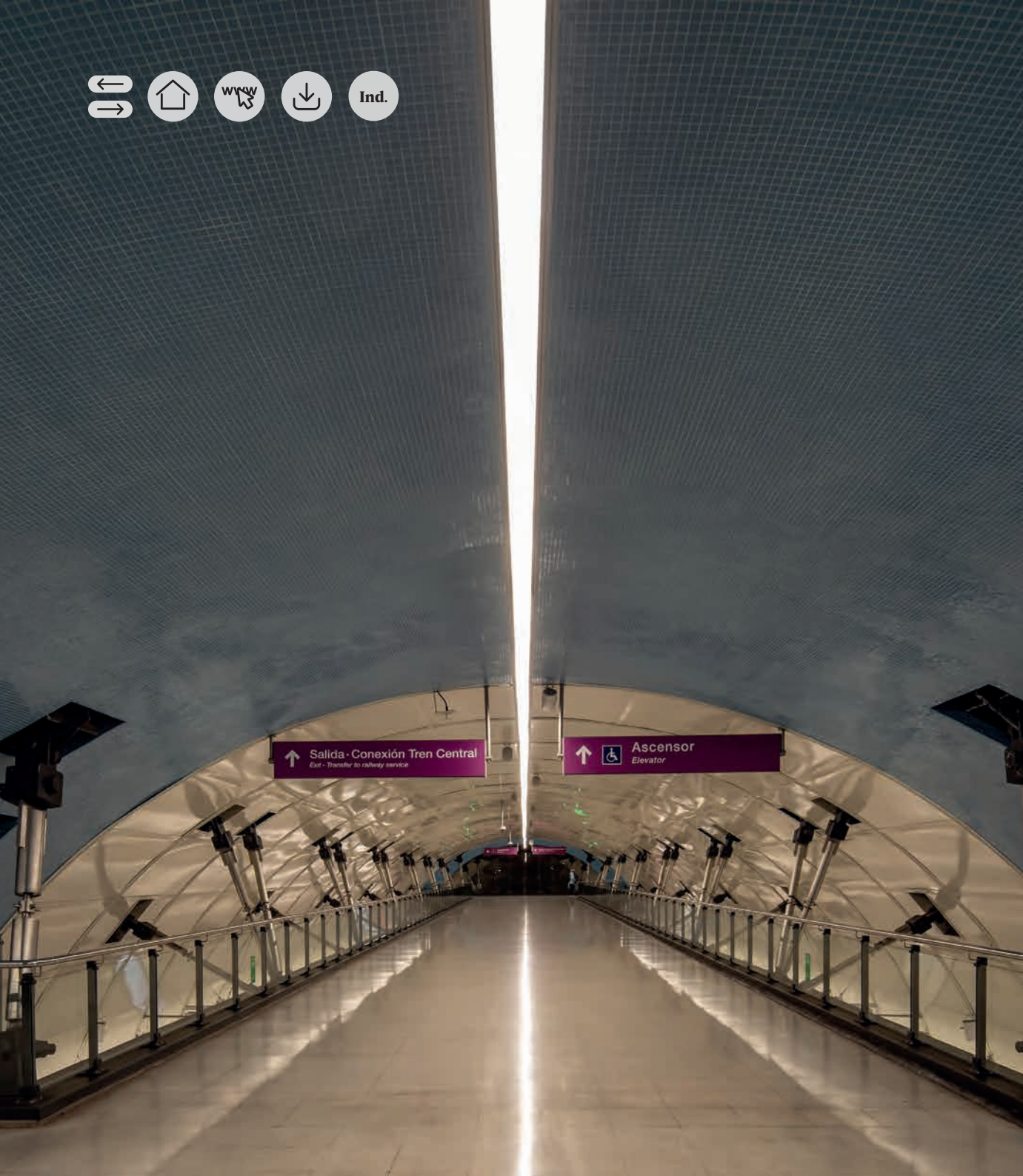

Transit



STGO

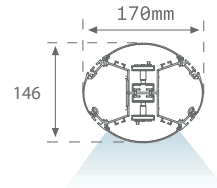

STGO

Familia	Formato	Lm LED	IP	Óptica	IRC	K	Equipo	Acabados
ST1	SU Suspended	MO Medium Output	42 42	OP Opal	8 80	40 4000 K	N ON/OFF	G Grey 01
ST1	SU	MO	42	OP	8	40	N	G

CARACTERÍSTICAS TÉCNICAS

Ópticas

STGO

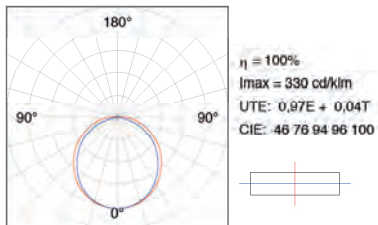

ACCESORIOS

Juego de 2 fijaciones para unión (2 unidades por referencia)



Ref.

F7J0





TLSE

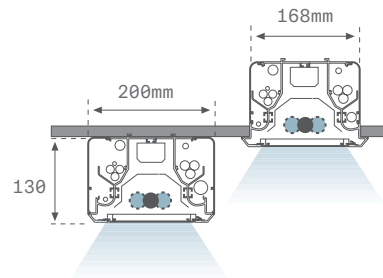

BCN

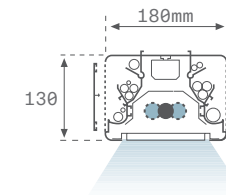

TLSE

Familia	Formato	Nº Lámparas	W	IP	Equipo	Acabados
TL1	SF Surface	1 Unit	36 W	20 20	N ON/OFF	W White
TL1	SF	1	36	20	N	W

BCN

Familia	Formato	Nº Lámparas	W	IP	Equipo	Acabados
BC1	SU Suspended	1 Unit	36 W	20 20	N ON/OFF	W White
BC1	SU	1	36	20	N	W



CARACTERÍSTICAS TÉCNICAS

Ópticas

TLSE

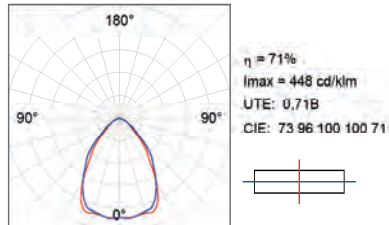

BCN

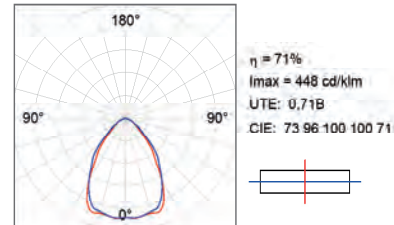

Flujo de salida y potencia

BCN

Format	K	CRI	6501m	
			W	lm Output
OP	4000	80	6	610

ACCESORIOS

Juego de 2 fijaciones para unión



Ref.

F5J0



Ind.

General Acc. Indoor

SUSPENSIONES: Fil 50, Fil 70, Fil 120, Lamptub (1unit/ref.)

Fijación directa decorativa para conexión eléctrica



Ref.	Color
SUCAEMDEW SUCAEMDEG	○ ●

Accesorio para unir 2 suspensiones rígidas

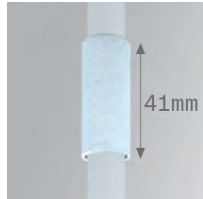

Ref.	Color
SURGJ041W	○

SUSPENSIONES: Fil 35, Fil 45

Cable de acero regulable



Ref.	Color	h(mm)
F42SUWIDE1500G F42SUWIDE3000G	● ●	1500 3000

Anclaje desde el extremo

Fijación directa

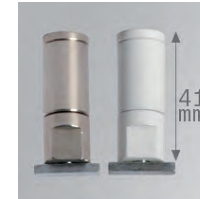

Ref.	Color
SFRG41W SFRG41G	○ ●

Cable de acero regulable para conexión electromecánica (3 o 5xø1,5)



Ref.	Color	h(mm)
F42SUCAEMF1500NB F42SUCAEMF1500NW F42SUCAEMF3000NB F42SUCAEMF3000NW	● ○ ● ○	1500 1500 3000 3000

DALI		
Ref.	Color	h(mm)
F42SUCAEMF1500DB F42SUCAEMF1500DW F42SUCAEMF3000DB F42SUCAEMF3000DW	● ○ ● ○	1500 1500 3000 3000

Anclaje desde el extremo

SUSPENSIONES: Fil 35, Fil 45, Fil 50, Fil 70, Fil 120, Lamptub (1unit/ref.)

Floron Recessed Basic

Ref.	Color	h(mm)
SUCAREBA1500NB	●	1500
SUCAREBA1500NW	○	1500
SUCAREBA3000NB	●	3000
SUCAREBA3000NW	○	3000
DALI		
SUCAREBA1500DB	●	1500
SUCAREBA1500DW	○	1500
SUCAREBA3000DB	●	3000
SUCAREBA3000DW	○	3000

Floron Recessed Deco

Ref.	Color	h(mm)
SUCAREDE1500NB	●	1500
SUCAREDE1500NW	○	1500
SUCAREDE3000NB	●	3000
SUCAREDE3000NW	○	3000
DALI		
SUCAREDE1500DB	●	1500
SUCAREDE1500DW	○	1500
SUCAREDE3000DB	●	3000
SUCAREDE3000DW	○	3000

SUSPENSIONES: Fil 50, Fil 70

Cable de acero regulable

Ref.	Color	h(mm)
F52SUWIDE1500G	●	1500
F52SUWIDE3000G	●	3000

Anclaje desde el extremo

Floron Surface Basic

Ref.	Color	h(mm)
SUCASFBA1500NB	●	1500
SUCASFBA1500NW	○	1500
SUCASFBA3000NB	●	3000
SUCASFBA3000NW	○	3000
DALI		
SUCASFBA1500DB	●	1500
SUCASFBA1500DW	○	1500
SUCASFBA3000DB	●	3000
SUCASFBA3000DW	○	3000

Floron Surface Deco

Ref.	Color	h(mm)
SUCASFDE1500NB	●	1500
SUCASFDE1500NW	○	1500
SUCASFDE3000NB	●	3000
SUCASFDE3000NW	○	3000
DALI		
SUCASFDE1500DB	●	1500
SUCASFDE1500DW	○	1500
SUCASFDE3000DB	●	3000
SUCASFDE3000DW	○	3000

SUSPENSIONES: Fil 120, BCN, STGO (1unit/ref.)

Suspensión electromecánica de dos cables acero

Ref.	Color	h(m)
SUEM2W3000NW	○	max. 3
SUEM2W3000NG	●	max. 3

Cable de acero regulable para conexión electromecánica (3 o 5xø1,5)



Ref.	Color	h(mm)
F42SUCAEMF1500NB	●	1500
F42SUCAEMF1500NW	○	1500
F42SUCAEMF3000NB	●	3000
F42SUCAEMF3000NW	○	3000
DALI		
F42SUCAEMF1500DB	●	1500
F42SUCAEMF1500DW	○	1500
F42SUCAEMF3000DB	●	3000
F42SUCAEMF3000DW	○	3000

Anclaje desde el extremo

SOPORTES A PARED: Fil 50, Fil 70, Fil 120, Lamptub (1unit/ref.)

Unión soporte corto pared 2 unit/ref.



Ref.	Color
F5FX75W	○
F5FX75G	●

Soporte pared orientable y extensible 2 unit/ref.



Ref.	Color
ARROEX40W	○
ARROEX40G	●

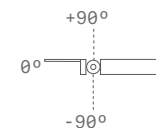

Soporte pared orientable 2 unit/ref.

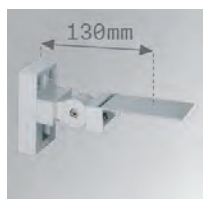

Ref.	Color
ARRO13W	○

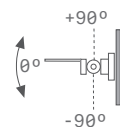

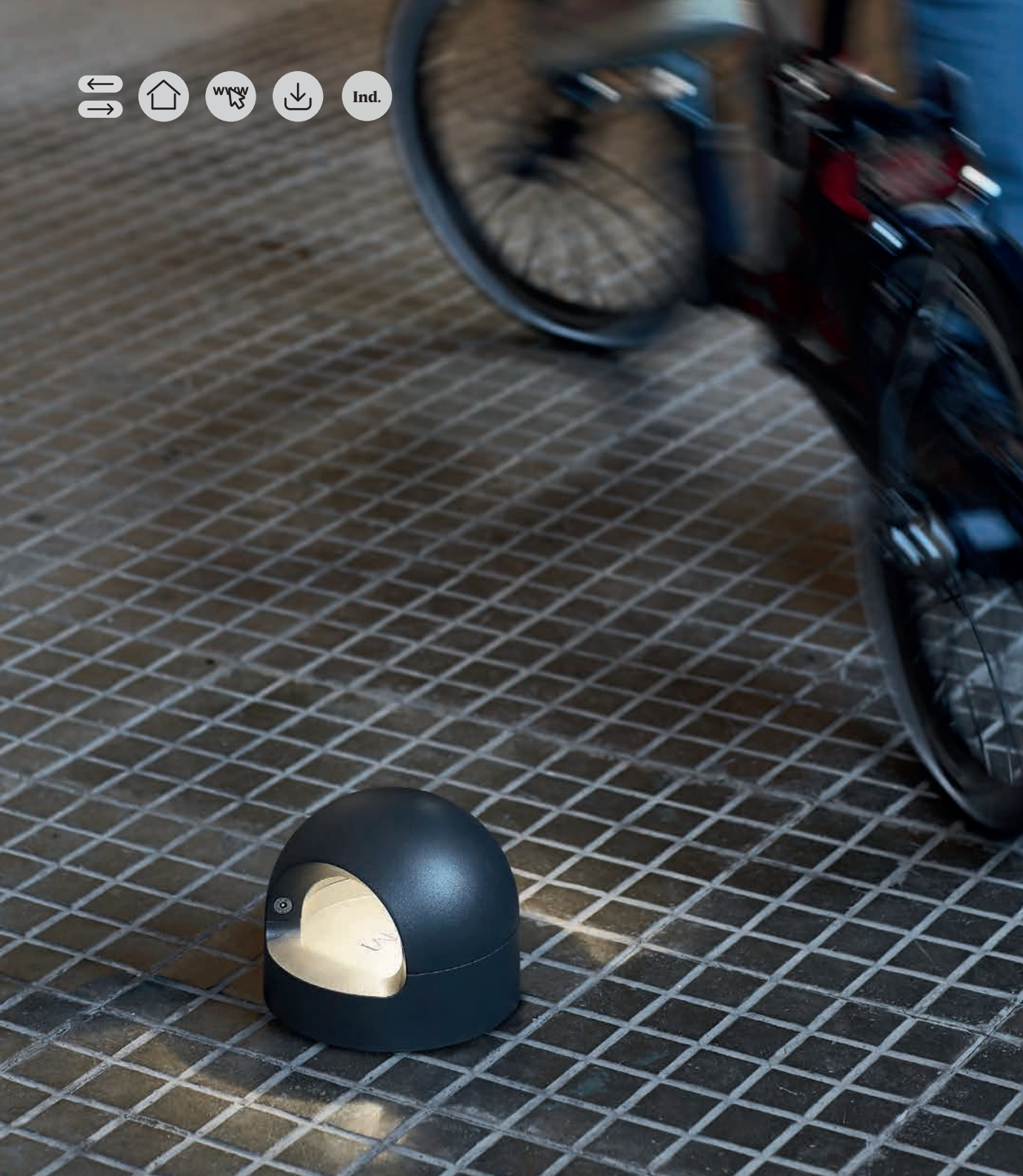

B-Side



B-Side
135

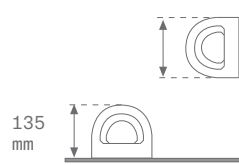

B-Side
450

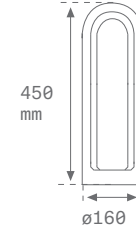

B-Side
850

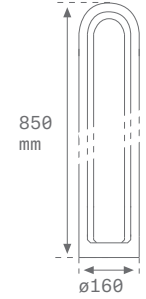

B-SIDE

Familia	Formato	Dimensión	Lm LED	IRC	K	Equipo	Acabados
BS1	DB Double	13 135mm	03 250lm	8 80	40 4000 K	N ON/OFF	G Grey 03 A Anthracite 01
		45 450mm	03 250lm				
		85 850mm	05 500lm				
BS1	DB	13	03	8	40	N	G

CARACTERÍSTICAS TÉCNICAS

Ópticas

135

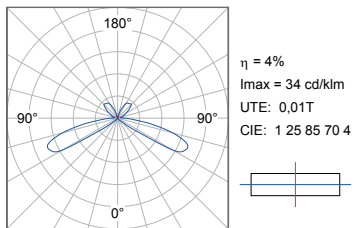

450

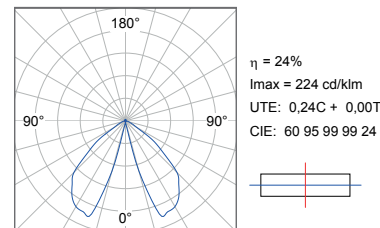

850

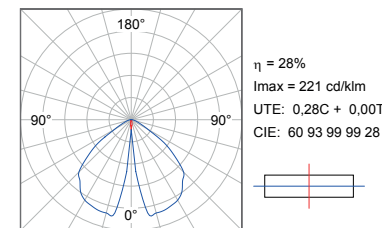

Flujo de salida y potencia

B-SIDE

Model	K	CRI	250lm		500lm	
			W	Im Output	W	Im Output
135	4000	80	3,5	138	-	-
450	4000	80	4,5	112	6,4	130
850	4000	80	4,5	112	6,4	171





B-Side 360°
250

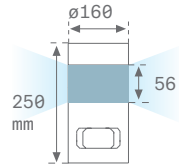

B-Side 360°
450

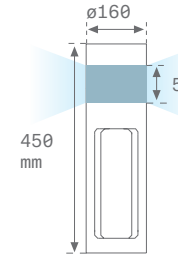

B-Side 360°
850

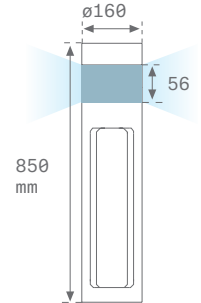

B-SIDE 360°

Familia	Formato	Dimensión	Lm LED	IRC	K	Equipo	Acabados
BS2	36 360°	25 250mm	10 1200lm	8 80	30 3000 K 40 4000 K	N ON/OFF	G Grey 03
		45 450mm					A Anthracite 01
		85 850mm					
		85 850mm	15 1500lm				
BS2	36	25	10	8	40	N	G

CARACTERÍSTICAS TÉCNICAS

Ópticas

250

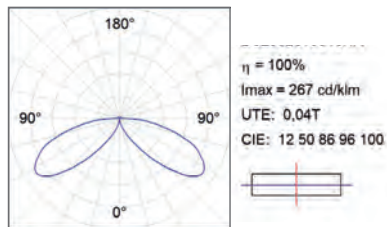

450

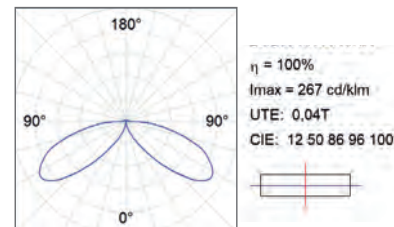

850

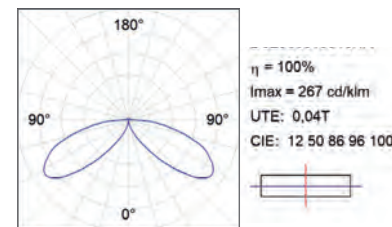

Flujo de salida y potencia

B-SIDE 360°

Model	K	CRI	1200lm		1500lm	
			W	lm Output	W	lm Output
235	3000	80	8,7	530	9,9	608
450	4000	80	8,7	560	9,9	644
850						





B-Side 180°
250

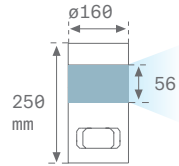

B-Side 180°
450

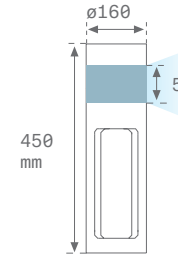

B-Side 180°
850

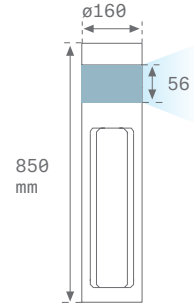

B-SIDE 360°

Familia	Formato	Dimensión	Lm LED	IRC	K	Equipo	Acabados
BS2	18 180°	25 250mm	10 1200lm	8 80	30 3000 K	N ON/OFF	G Grey 03 A Anthracite 01
		45 450mm	40 4000 K				
		85 850mm					
		85 850mm	15 1500lm				
BS2	18	25	10	8	40	N	G

CARACTERÍSTICAS TÉCNICAS

Ópticas

250

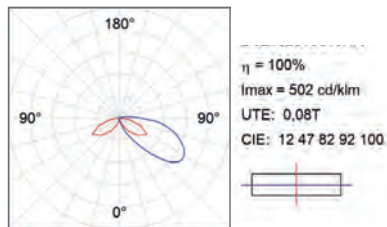

450

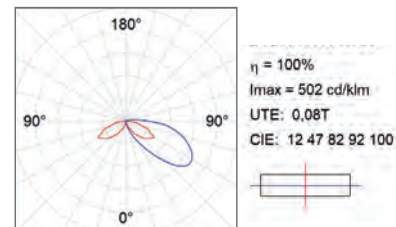

850

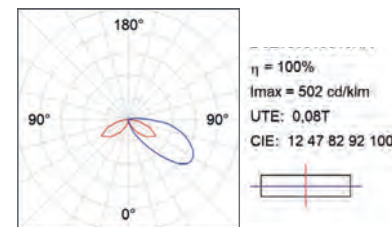

Flujo de salida y potencia

B-SIDE 180°

Model	K	CRI	1200lm		1500lm	
			W	lm Output	W	lm Output
250	3000	80	8,7	350	9,9	405
450	4000	80	8,7	370	9,9	429
850						





Bauline



PRESENTACIÓN FAMILIA

Ind.



Bauline
Recessed

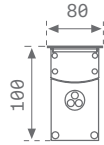

Bauline
Surface

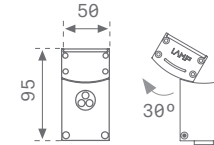

BAULINE

Familia	Instalación	Longitud	Lm LED/m	Óptica	IRC	K	Equipo	Acabados
BA3	RE Recessed	068 680mm	MO 3900lm/m	SP SP 13° MF MFL 21° EL Elliptic	8 80	30 3000 40 4000	N ON/OFF	G Grey 02
		127 1270mm						
	SF Surface	065 650mm 124 1240mm						
BA3	RE	068	MO	SP	8	30	N	G



CARACTERÍSTICAS TÉCNICAS

Ópticas

SP 13°

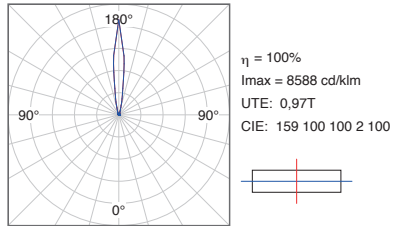

MFL 21°

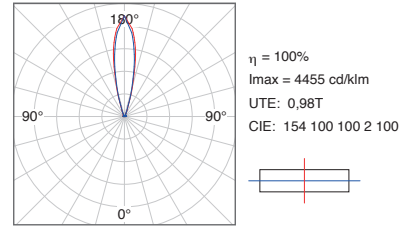

EL

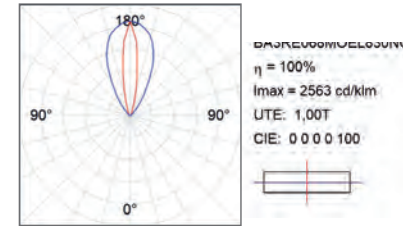

Flujo de salida y potencia

BAULINE RECESSED

	K	CRI	680mm		1270mm	
			W	lm Output	W	lm Output
SP 13°	3000	80	16,2	1916	32,3	3921
	4000	80	16,2	1916	32,3	3921
MFL 21°	3000	80	16,2	1996	32,3	3994
	4000	80	16,2	1996	32,3	3994
EL	3000	80	16,2	1916	32,3	3832
	4000	80	16,2	1916	32,3	3832

BAULINE SURFACE

	K	CRI	650mm		1240mm	
			W	lm Output	W	lm Output
SP 13°	3000	80	16,2	1937	32,3	3873
	4000	80	16,2	1937	32,3	3873
MFL 21°	3000	80	16,2	1972	32,3	3945
	4000	80	16,2	1972	32,3	3945
EL	3000	80	16,2	1916	32,3	3832
	4000	80	16,2	1916	32,3	3832



ACCESORIOS

Caja empotramiento para BAULINE con equipo

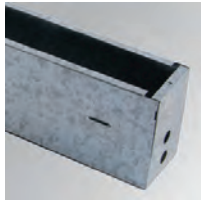

Ref.

BUREB00683
BUREB01272

Lmm

683
1272

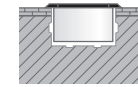
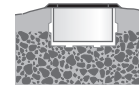
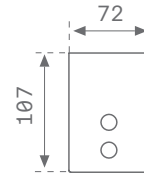

Evite su colocación en depresiones del terreno
Drenaje obligatorio

ACCESORIOS de superficie

Soporte a pared orientable (2unidades por referencia)



Ref.

WAAR120G

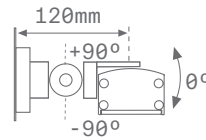

Soporte pared orientable y extensible (2unidades por referencia)



Ref.

WAAR380G

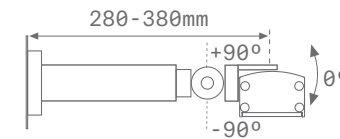

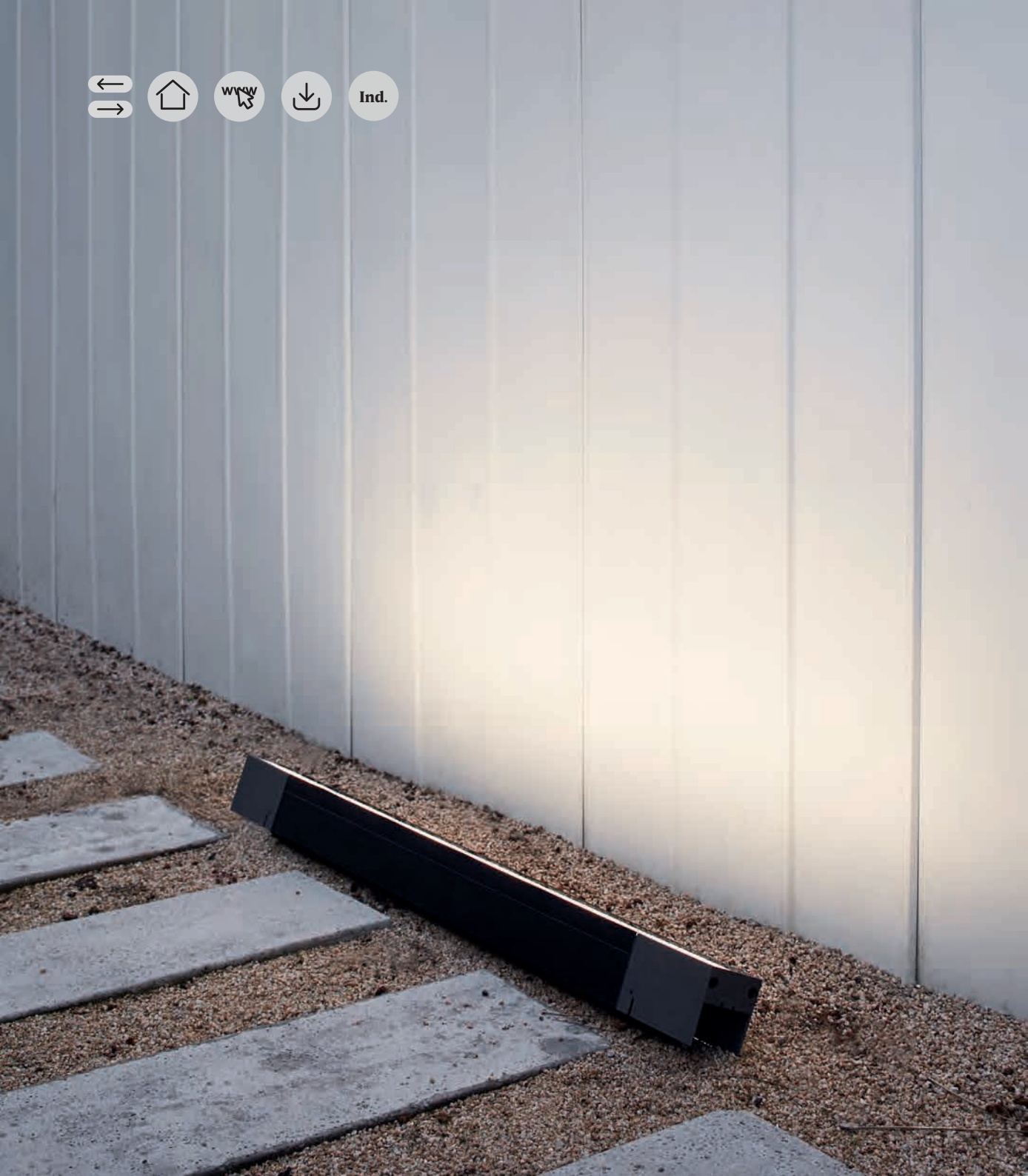

Bazz



Bazz
Symmetric

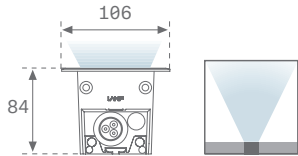

Bazz
Asymmetric

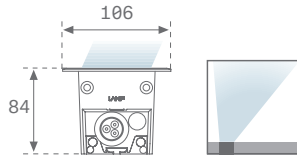

Bazz
Wall Washer

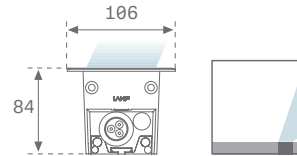

Bazz
Opal

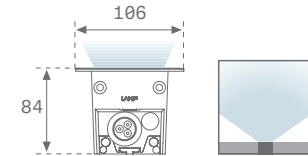
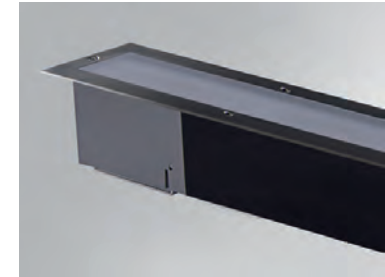

BAZZ SYMMETRIC ASYMMETRIC

Familia	Instalación	Formato	Lm LED	Óptica	IRC	K	Equipo	Acabados
BZ1	RE Recessed	100 1043mm	LO 2800lm	SY Symmetric	8 80	30 3000 K 40 4000 K	N ON/OFF	B Black 06
		200 2036mm	MO 5600lm	AS Asymmetric				
BZ1	RE	100	LO	SY	8	30	N	B

BAZZ WALL WASHER

Familia	Instalación	Formato	Lm LED	Óptica	IRC	K	Equipo	Acabados
BZ1	RE Recessed	100 1043mm	MO 4200lm	WW Wall Washer	8 80	30 3000 K 40 4000 K	N ON/OFF	B Black 06
		200 2036mm						
BZ1	RE	100	MO	WW	8	30	N	B

BAZZ OPAL

Familia	Instalación	Formato	Lm LED	Óptica	IRC	K	Equipo	Acabados
BZ1	RE Recessed	100 1043mm	MO 4200lm	OP Opal	8 80	30 3000 K 40 4000 K	N ON/OFF	B Black 06
		200 2036mm						
BZ1	RE	100	MO	OP	8	30	N	B



CARACTERÍSTICAS TÉCNICAS

Ópticas

SYMMETRIC

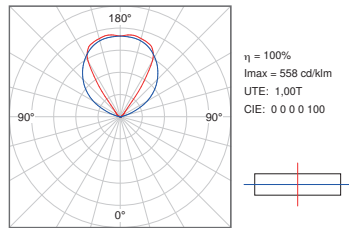

ASYMMETRIC

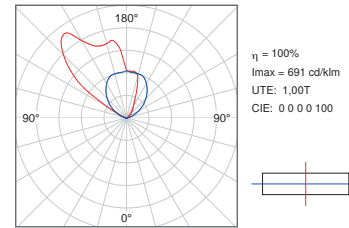

WALL WASHER

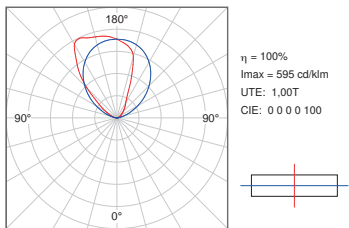

OPAL

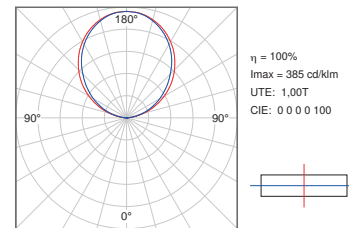

Flujo de salida y potencia

BAZZ RECESSED

				1000mm		2000mm	
		K	CRI	W	lm Output	W	lm Output
LO	SY	3000	80	20,6	2047	40	4094
		4000	80	20,6	2149	40	4299
	AS	3000	80	20,6	1981	40	3962
		4000	80	20,6	2080	40	4160
MO	SY	3000	80	40	4024	77	8048
		4000	80	40	4225	77	8450
	AS	3000	80	40	3883	77	7766
		4000	80	40	4077	77	8158
	WW	3000	80	40	2572	77	5144
		4000	80	40	2701	77	5401
	OP	3000	80	34,8	1528	66	3056
		4000	80	34,8	1604	66	3209

ACCESORIOS

Caja empotramiento para BAZZ



Ref.

BZREB01000
BZREB02000

Lmm

1035
2028

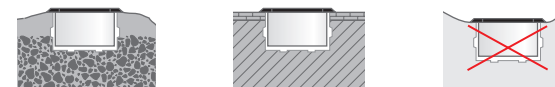
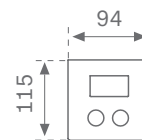

Evite su colocación en depresiones del terreno
Drenaje obligatorio

Conector de 3 polos IP68



Ref.

CT3P680
CT3P68G

Color

●
●

ømm

8-10
6,5-12



Bazz Air
Symmetric

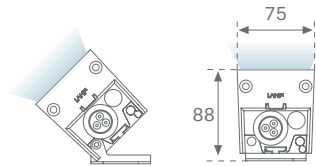

Bazz Air
Asymmetric

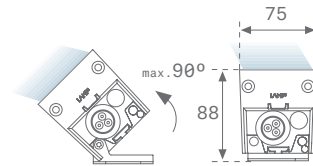

Bazz Air
Wall Washer

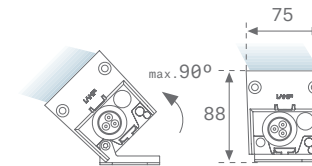

Bazz Air
Opal

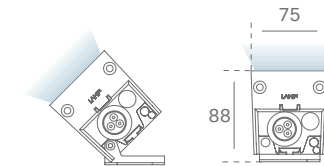
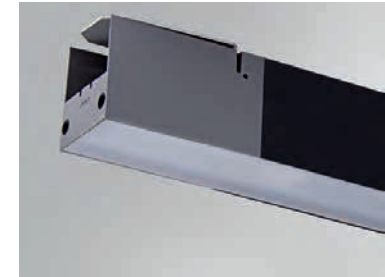

BAZZ AIR SYMMETRIC ASYMMETRIC

Familia	Instalación	Formato	Lm LED	Óptica	IRC	K	Equipo	Acabados
BZ1	SF Surface	100 1008mm	LO 2800lm	SY Symmetric	8 80	30 3000 K 40 4000 K	N ON/OFF	B Black 06
		200 2001mm	MO 5600lm	AS Asymmetric				
BZ1	SF	100	LO	SY	8	30	N	B

BAZZ AIR WALL WASHER

Familia	Instalación	Formato	Lm LED	Óptica	IRC	K	Equipo	Acabados
BZ1	SF Surface	100 1008mm	MO 4200lm	WW Wall Washer	8 80	30 3000 K 40 4000 K	N ON/OFF	B Black 06
		200 2001mm						
BZ1	SF	100	MO	WW	8	30	N	B

BAZZ AIR OPAL

Familia	Instalación	Formato	Lm LED	Óptica	IRC	K	Equipo	Acabados
BZ1	SF Surface	100 1008mm	MO 4200lm	OP Opal	8 80	30 3000 K 40 4000 K	N ON/OFF	B Black 06
		200 2001mm						
BZ1	SF	100	MO	OP	8	30	N	B





CARACTERÍSTICAS TÉCNICAS

Ópticas

SYMMETRIC

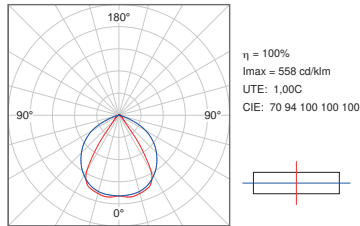

ASYMMETRIC

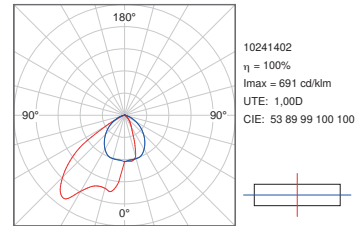

WALL WASHER

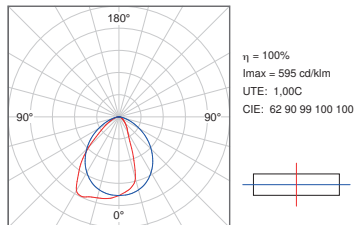

OPAL

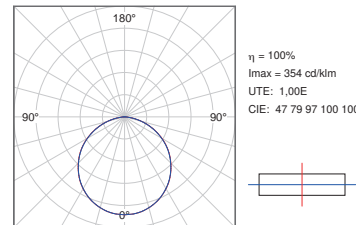

Flujo de salida y potencia

BAZZ AIR

				1000mm		2000mm	
		K	CRI	W	lm Output	W	lm Output
LO	SY	3000	80	20,6	2010	40	4020
		4000	80	20,6	2111	40	4221
	AS	3000	80	20,6	1945	40	3891
		4000	80	20,6	2043	40	4089
MO	SY	3000	80	40	4020	77	7903
		4000	80	40	4221	77	8289
	AS	3000	80	40	2891	77	7626
		4000	80	40	4089	77	8008
	WW	3000	80	40	2526	77	5051
		4000	80	40	2652	77	5304
	OP	3000	80	35	1490	66	2980
		4000	80	35	1565	66	3129

ACCESORIOS

Unión línea continua



Ref.

BZJ0

Cable de acero regulable 1 unit. / ref. Se necesitan 2 unit. / lum.



Ref.

SUWIDE1000G
SUWIDE4000G

mm

1000
4000

Abrazaderas de aluminio BAZZ para columna Ø 120-130mm



Ref.

BZSFCL1
BZSFCL2

Color



Kg

1,65 1 Bazz
2,20 2 Bazz

Soporte pared orientable y extensible 2 unit. / ref.



Ref.

ARROEX40G

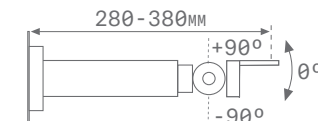



Duit

Configuración

1. Motor Lumínico



Driver



2. Accesorios de instalación

Basic	Surface		
	Empotrado		
Integration	Empotrado Asimetrico		
	Trimless		
Minimum	Surface		



3. Accesorios Ópticos

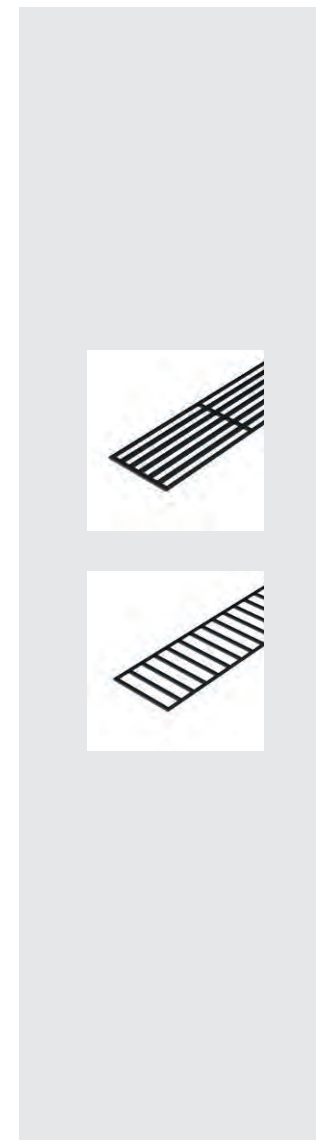



Duit Light Engine Ambient

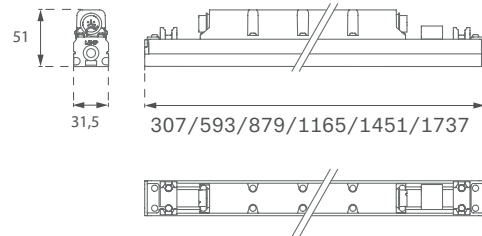

Duit Light Engine

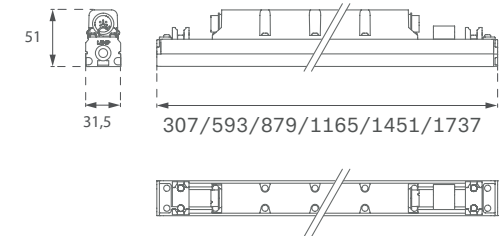

DUIT LIGHT ENGINE AMBIENT

Familia	Instalación	Formato	Lm LED/m	Óptica	IRC	K	Equipo	Acabados	
DT1	SF Surface	300 300mm	A0 1000lm	WF Wide Flood	8 80	27 2700 K	0 0	B Black 06	
		600 600mm		WW Wall Washer		30 3000 K			
		900 900mm		GZ Grazer		40 4000 K			
		120 1200mm		OP Opal					
		150 1500mm		GZ Grazer		8 80			A Amber
		180 1800mm		WW Wall Washer					

DT1	SF	300	A0	WF	8	27	0	B
------------	-----------	------------	-----------	-----------	----------	-----------	----------	----------

DUIT LIGHT ENGINE

Familia	Instalación	Formato	Lm LED/m	Óptica	IRC	K	Equipo	Acabados	
DT1	SF Surface	300 300mm	L0 2160lm	WF Wide Flood	8 80	27 2700 K	0 0	B Black 06	
		600 600mm		WW Wall Washer		30 3000 K			
		900 900mm		GZ Grazer		40 4000 K			
		120 1200mm		GZ Grazer		8 80			A Amber
		150 1500mm		WW Wall Washer					
		180 1800mm							

DT1	SF	300	L0	WF	8	27	0	B
------------	-----------	------------	-----------	-----------	----------	-----------	----------	----------





CARACTERÍSTICAS TÉCNICAS

Flujo de salida y potencia

DUIT

				300mm		600mm		900mm		1200mm		1500mm		1800mm	
	K	CRI	W	lm Output	W	lm Output	W	lm Output	W	lm Output	W	lm Output	W	lm Output	
AO	WF	2700	80	1,3	102	2,6	204	3,9	306	5,2	408	6,5	510	7,8	612
		3000	80	1,3	105	2,6	209	3,9	314	5,2	418	6,5	523	7,8	627
		4000	80	1,3	111	2,6	221	3,9	332	5,2	442	6,5	553	7,8	663
		Amber	80	-	-	-	-	-	-	-	-	-	-	-	-
	WW	2700	80	1,3	96	2,6	193	3,9	289	5,2	386	6,5	482	7,8	578
		3000	80	1,3	100	2,6	199	3,9	299	5,2	398	6,5	498	7,8	597
		4000	80	1,3	105	2,6	210	3,9	315	5,2	420	6,5	525	7,8	630
		Amber	80	1,3	113	2,6	226	3,9	339	5,2	452	6,5	565	7,8	678
	OP	2700	80	1,3	95	2,6	191	3,9	286	5,2	382	6,5	477	7,8	573
		3000	80	1,3	97	2,6	195	3,9	292	5,2	390	6,5	487	7,8	585
		4000	80	1,3	103	2,6	206	3,9	309	5,2	412	6,5	515	7,8	619
		Amber	80	-	-	-	-	-	-	-	-	-	-	-	-
	GZ	2700	80	1,3	120	2,6	240	3,9	360	5,2	480	6,5	600	7,8	720
		3000	80	1,3	123	2,6	246	3,9	369	5,2	492	6,5	615	7,8	738
		4000	80	1,3	130	2,6	260	3,9	390	5,2	520	6,5	650	7,8	780
		Amber	80	1,3	139	2,6	278	3,9	417	5,2	556	6,5	695	7,8	834
LO	WF	2700	80	3,3	291	6,6	581	9,9	872	13,2	1163	16,5	1454	19,8	1744
		3000	80	3,3	299	6,6	598	9,9	898	13,2	1197	16,5	1496	19,8	1795
		4000	80	3,3	316	6,6	632	9,9	949	13,2	1265	16,5	1581	19,8	1897
		TW	-	-	-	-	-	-	-	-	-	-	-	-	-
	WW	2700	80	3,3	279	6,6	558	9,9	837	13,2	1115	16,5	1394	19,8	1673
		3000	80	3,3	287	6,6	574	9,9	860	13,2	1147	16,5	1434	19,8	1721
		4000	80	3,3	316	6,6	632	9,9	949	13,2	1265	16,5	1581	19,8	1897
		Amber	80	3,3	317	6,6	634	9,9	950	13,5	1267	16,5	1584	19,8	1901
	GZ	2700	80	3,3	342	6,6	684	9,9	1026	13,2	1368	16,5	1710	19,8	2052
		3000	80	3,3	353	6,6	704	9,9	1056	13,2	1408	16,5	1760	19,8	2112
		4000	80	3,3	372	6,6	744	9,9	1116	13,2	1488	16,5	1860	19,8	2232
		Amber	80	3,3	390	6,6	780	9,9	1170	13,2	1560	19,5	1950	19,8	2340



CARACTERÍSTICAS TÉCNICAS

Ópticas

WF

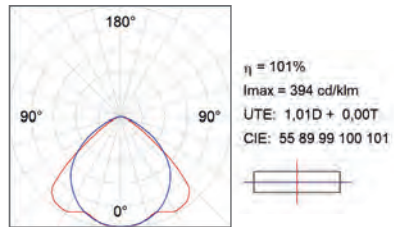

WW

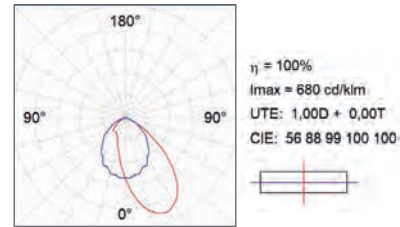

GZ

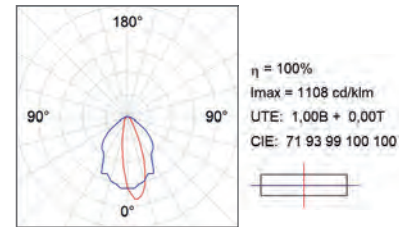

OP

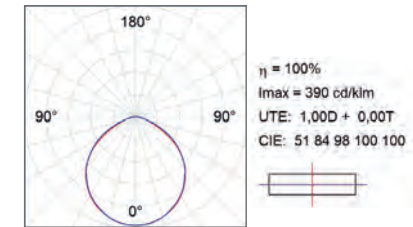



ACCESORIOS DE INSTALACIÓN BASIC

Perfil basic superficie



Ref.	Color
DTBASFPR600B	●
DTBASFPR900B	●
DTBASFPR1200B	●
DTBASFPR1500B	●
DTBASFPR1800B	●

Perfil basico indirect



Ref.	Color
DTBAIDPR600B	●
DTBAIDPR900B	●
DTBAIDPR1200B	●
DTBAIDPR1500B	●
DTBAIDPR1800B	●

Perfil basico empotrado



Ref.	Color
DTBAREB0300I	●
DTBAREB0600I	●
DTBAREB01200I	●
DTBAREB01500I	●
DTBAREB01800I	●
DTBAREB01200I	●

Tapa final superficie



Ref.
DTBASFCB

Suspensión rígida



Ref.
DTBASUG0100I

Cable de acero regulable



Ref.
Direct:
F3SUWIDE1000G
F3SUWIDE4000G
Indirect:
DTBAIDSUWIDE1000G
DTBAIDSUWIDE4000G

Junta intermedia



Ref.
DTBAJO

Unión soporte pared 2 unit. / ref.



Ref.
DTBAFX45

Soporte pared orientable 2 unit. / ref.



Ref.
DTBASUAJ50



ACCESORIOS PERFIL INTEGRATION

Perfil integration trimless



Ref.	Color
DTBATRPR600B	●
DTBATRPR900B	●
DTBATRPR1200B	●
DTBATRPR1500B	●
DTBATRPR1800B	●

Perfil integration empotrado asimétrico

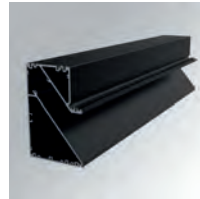

Ref.	Color
DTBAASPR600B	●
DTBAASPR900B	●
DTBAASPR1200B	●
DTBAASPR1500B	●
DTBAASPR1800B	●

Tapa final trimless



Ref.
DTBATRCB

Tapa final empotrado asimétrico 2 unit. / ref.



Ref.
DTBAASRCB

Junta intermedia trimless



Ref.
DTBATRJO

Junta intermedia empotrado asimétrico



Ref.
DTBAASJO



ACCESORIOS PERFIL MINIMUM

Anclaje en esquina



Ref.
DTFCRI

Anclaje horizontal



Ref.
DTFXVI

Anclaje lateral



Ref.
DTFSII

ACCESORIOS ÓPTICOS

Rejilla antideslumbrante horizontal

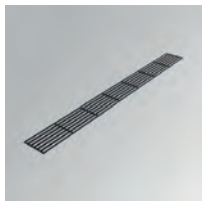

Ref.
DTLOH300BK
DTLOH600BK
DTLOH900BK
DTLOH1200BK
DTLOH1500BK
DTLOH1800BK

Rejilla antideslumbrante vertical

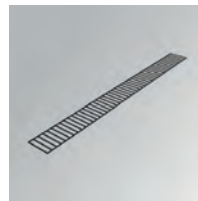

Ref.
DTLOV300BK
DTLOV600BK
DTLOV900BK
DTLOV1200BK
DTLOV1500BK
DTLOV1800BK

ACCESORIOS

Manguera



Ref.
WI2X1NG

Tunable White:
WI3X1NG

Conector



Ref.
CT3P67N
CTY6P67N



POSIBILIDADES DE INSTALACIÓN

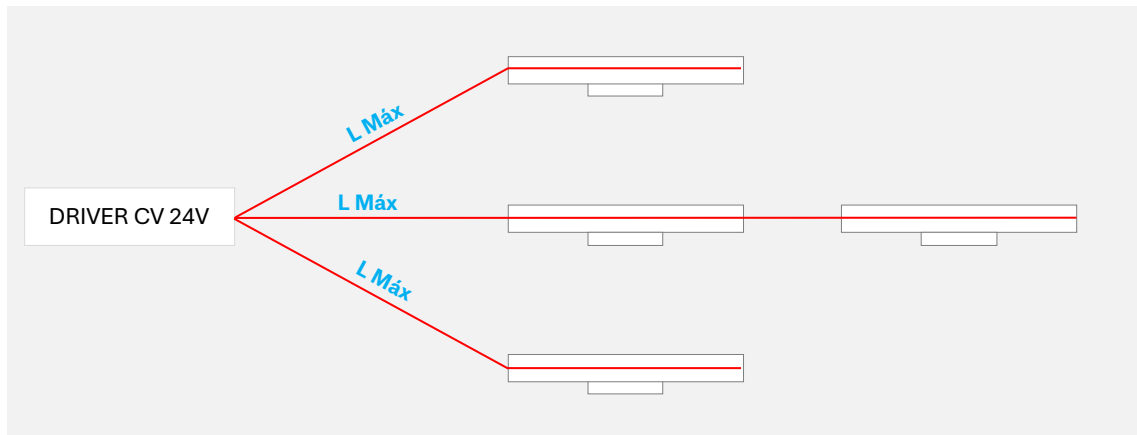
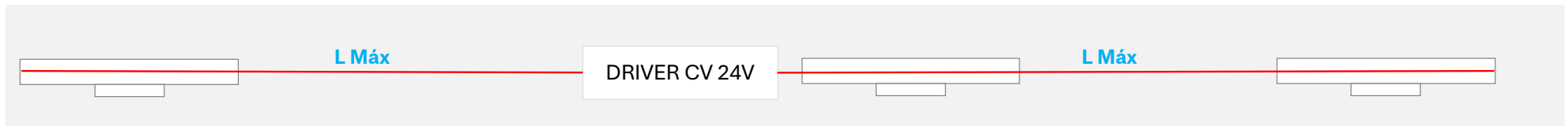
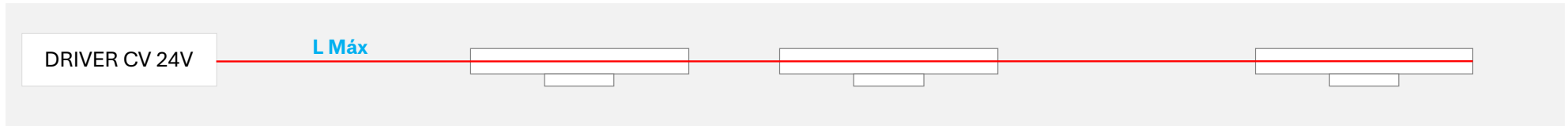

L Máx ≤ Distancia máxima entre driver y última luminaria.

DISTANCIA MÁXIMA ADMITIDA

	CONSUMO MÁXIMO (W)	LONGITUD MÁXIMA (M)
ON/OFF		
	DRV673024N	28 W / 18 M
	DRV677524N	71 W / 7 M
	DRV6710024N	95 W / 5 M
DALI		
	DRV676024D	57 W / 9 M
	DRV679024D	85 W / 11 M
	DRV6712024D	114 W / 5 M

- Escoger siempre el valor más restrictivo para elegir los equipos de alimentación por línea de luminarias, bien consumo máximo, distancia máxima entre driver y última luminaria.

Duit | Outdoor

DRIVERS ON/OFF CV 24V

Fuente de alimentación ON/OFF



Ref.
DRV673024N

Fuente de alimentación ON/OFF



Ref.
DRV677524N

Fuente de alimentación ON/OFF



Ref.
DRV6710024N

DRIVERS DALI

Fuente de alimentación DALI



Ref.
DRV679024D

Fuente de alimentación DALI



Ref.
DRV6712024D

Fuente de alimentación DALI



Ref.
DRV676024D



PRESENTACIÓN FAMILIA

Ind.



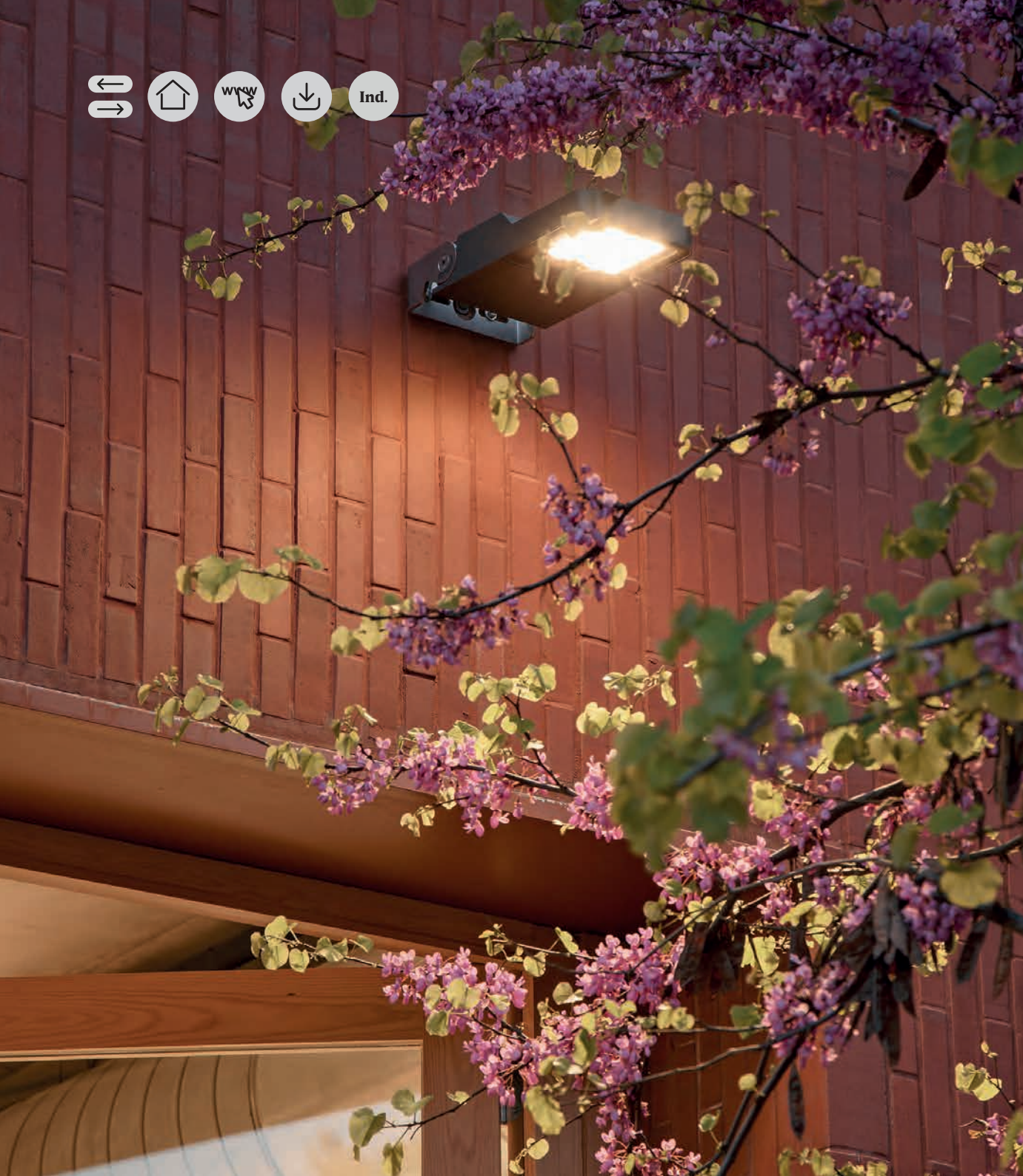

Flut



Flut 180
Symmetric

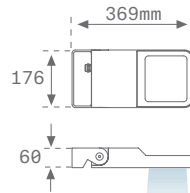

Flut 180
Asymmetric

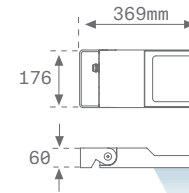

Flut 180
Street

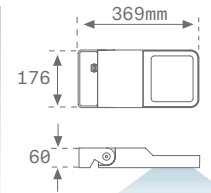

FLUT 180

Familia	Lm LED	Óptica	IRC	K	Equipo	Acabados
MF2	35 3500lm	AS Asymmetric	8 80	30 3000 K	N ON/OFF	G Grey 03
	65 6500lm	SY Symmetric		40 4000 K		A Anthracite 01
		ST Street				
MF2	35	AS	8	30	N	G

CARACTERÍSTICAS TÉCNICAS

Ópticas

SYMMETRIC

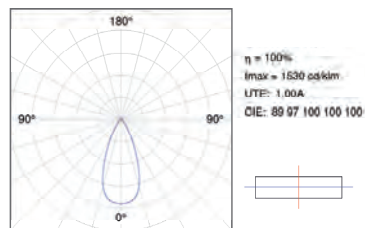

ASYMMETRIC

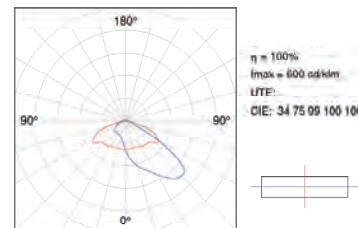

STREET

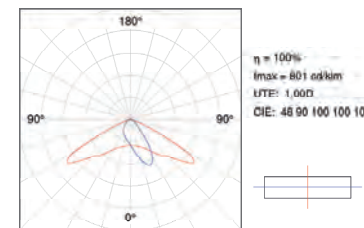

Flujo de salida y potencia

FLUT 180

	K	CRI	3500lm		6500lm	
			W	lm Output	W	lm Output
SY	3000	80	25,7	2937	49,1	4768
	4000	80	25,7	3092	49,1	5019
AS	3000	80	25,7	2460	49,1	4491
	4000	80	25,7	2589	49,1	4728
ST	3000	80	25,7	2672	49,1	4741
	4000	80	25,7	2813	49,1	4991

STREET





Aletas antideslumbrantes Street



Ref.	Color
MFLOSTB	● Street

Aletas antideslumbrantes Asymmetric



Ref.	Color
MFLOASB	● Asymmetric

Abrazaderas de aluminio Shot/Flut/Mini Flut para columna ø120-130 mm



	Ref.	Color
1 lum.	COARIN120G COARIN120A	● ●
2 lum.	COARDB120G COARDB120A	● ●

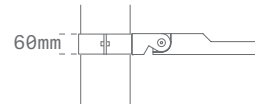

Soporte fijación Shot/Flut/Mini Flut de aluminio para columna ø60-135 mm



	Ref.	Color
1 lum.	COARIN060G COARIN060A	● ●

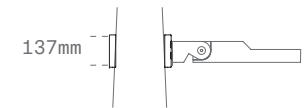



Flut 280
Symmetric

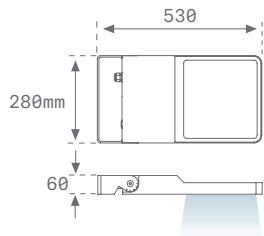

Flut 280
Asymmetric

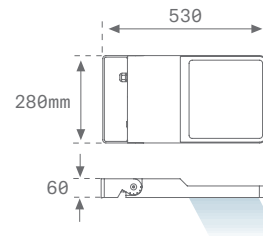

Flut 280
Street

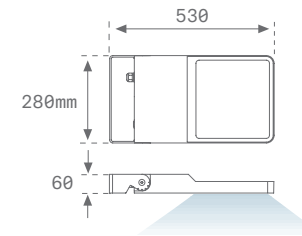

FLUT 280

Familia	Lm LED	Óptica	IRC	K	Equipo	Acabados
FL2	09 9300lm 14 14000lm 19 18700lm	AS Asymmetric SY Symmetric ST Street	8 80	30 3000 K 40 4000 K	N ON/OFF	G Grey 03 A Anthracite 01
FL2	09	AS	8	30	N	G

STREET



CARACTERÍSTICAS TÉCNICAS

Ópticas

SYMMETRIC

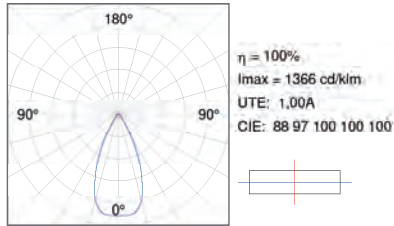

ASYMMETRIC

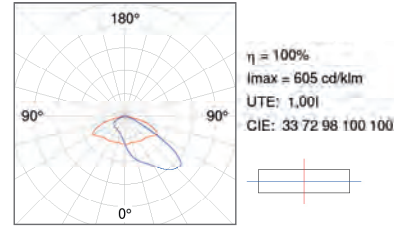

STREET

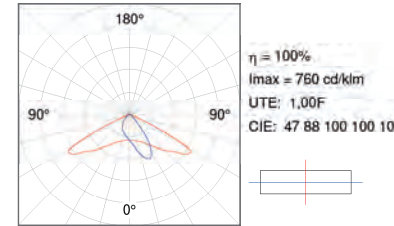

Flujo de salida y potencia

FLUT 280

	K	CRI	9300lm		14000lm		18700lm	
			W	lm Output	W	lm Output	W	lm Output
SY	3000	80	64,9	8161	97,7	11833	125,6	15430
	4000	80	64,9	8591	97,7	12455	125,6	16242
AS	3000	80	64,9	7687	97,7	11608	125,6	15256
	4000	80	64,9	8092	97,7	12219	125,6	16060
ST	3000	80	64,9	8117	97,7	12039	125,6	16058
	4000	80	64,9	8543	97,7	12673	125,6	16903



ACCESORIOS

Aletas antideslumbrantes Street



Ref.	Color
FLL0STB	● Street

Aletas antideslumbrantes Asymmetric



Ref.	Color
FLL0AS1B	● Asymmetric 32/64 LED
FLL0AS1B	● Asymmetric 18 LED

Abrazaderas de aluminio Shot/Flut/Mini Flut para columna ø120-130 mm



	Ref.	Color
1 lum.	COARIN120G COARIN120A	●
2 lum.	COARDB120G COARDB120A	●

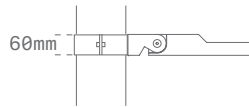

Soporte fijación Shot/Flut/Mini Flut de aluminio para columna ø60-135 mm



	Ref.	Color
1 lum.	COARIN060G COARIN060A	●

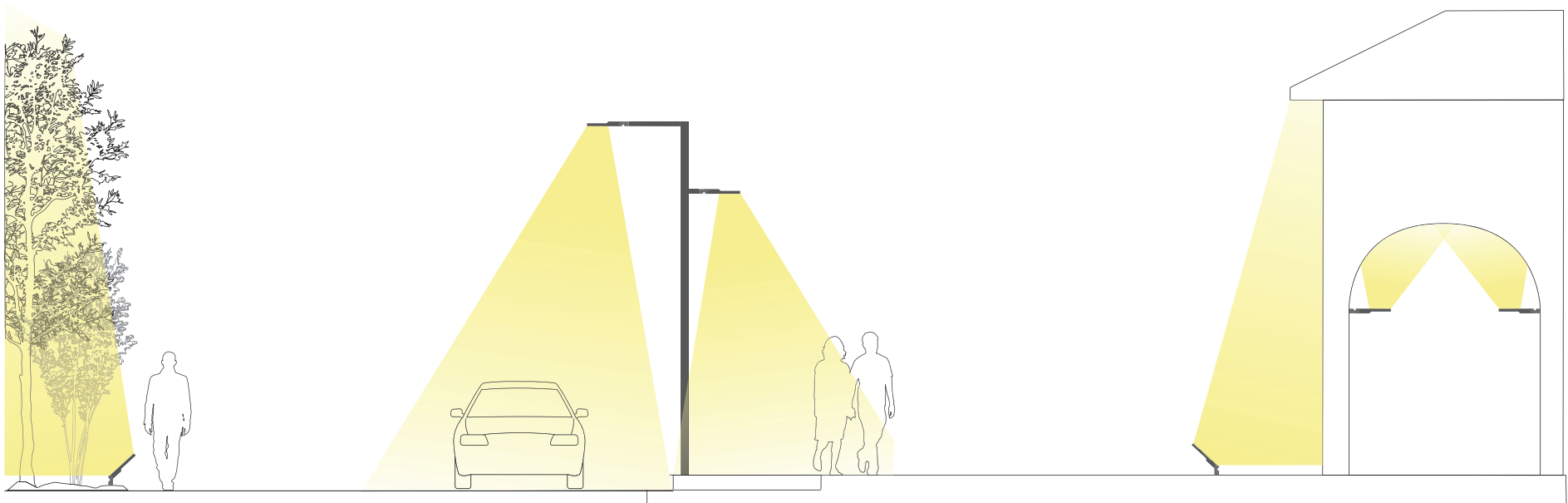
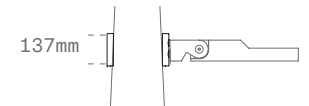



Gap



Gap

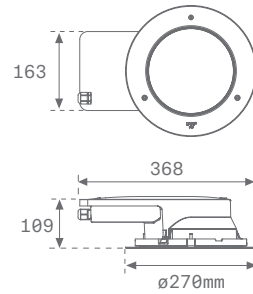

GAP

Familia	Lm LED	Óptica	IRC	K	Equipo	Acabados
GA2	15 1400lm	SP SP 11°	8 80	30 3000 K	N ON/OFF	I Inox 02
	30 2800lm	MF MFL 23°		40 4000 K		
	35 3600lm	WF WFL 46°				
GA2	15	SP	8	30	N	I



CARACTERÍSTICAS TÉCNICAS

Ópticas

SP 11°

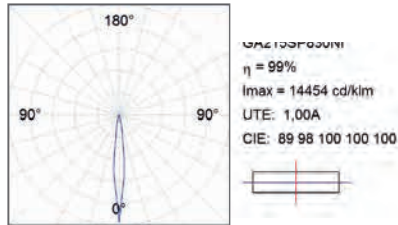

MFL 23°

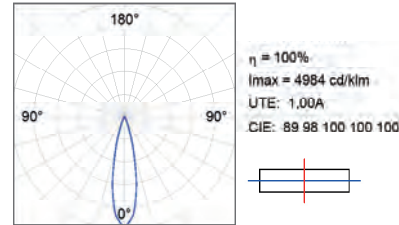

WFL 46°

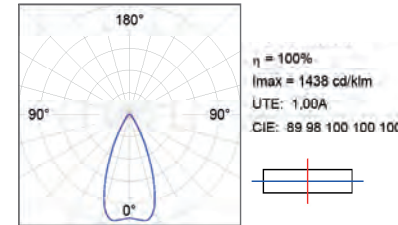

Flujo de salida y potencia

GAP

	K	CRI	1400lm		2800lm		3600lm	
			W	lm Output	W	lm Output	W	lm Output
SP 11°	3000	80	13	1130	23	2171	33,5	2944
	4000	80	13	1130	23	2171	33,5	2944
MFL 23°	3000	80	13	1081	23	2113	33,5	2851
	4000	80	13	1081	23	2113	33,5	2851
WFL 46°	3000	80	13	1092	23	2124	33,5	2877
	4000	80	13	1092	23	2124	33,5	2877

ACCESORIOS

Aro empotramiento falso techo y marco embellecedor



Ref.
GARERIRDM

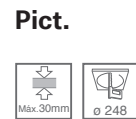

Caja de empotramiento



Ref.
GAREBOB

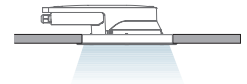
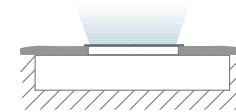
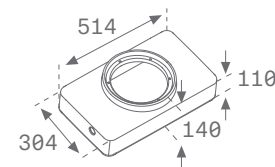



Lup



Lup ø70
1300lm

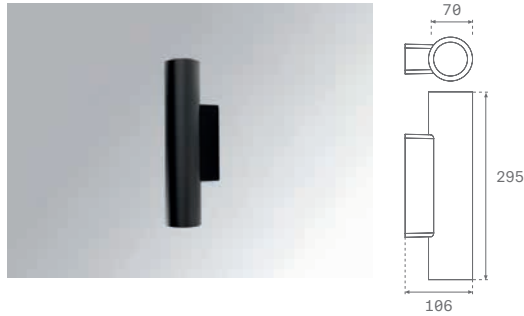

Lup ø110
3000lm

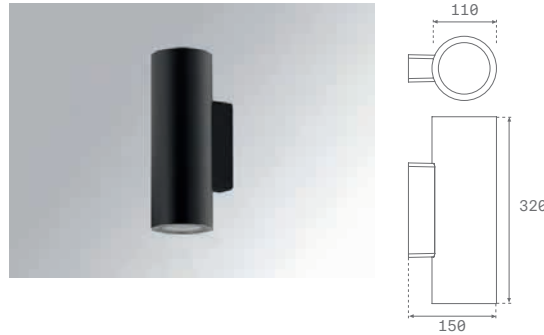

LUP DIRECT

Familia	Diámetro	Óptica	Lm LED	Óptica	K	Equipo	Acabados
LW1	70 ø70mm	DR Direct	10 1300lm	AS Asymmetric	30 3000 K 40 4000 K	N ON/OFF	B Black 03
	110 ø100mm	DR Direct	30 3000lm	AS Asymmetric	40 4000 K	N ON/OFF	B Black 03
LW1	70	DR	10	AS	30	N	B

LUP DIRECT-INDIRECT

Familia	Diámetro	Óptica	Lm LED	Óptica	K	Equipo	Acabados
LW1	70 ø70mm	DI Direct-Indirect	10 650+650lm	SP SP 10° MF MFL 38° WF WFL 60°	30 3000 K 40 4000 K	N ON/OFF	B Black 03
	110 ø100mm	DI Direct-Indirect	40 2000+2000lm	SP SP 16° FL FL 32° WF WFL 53°	40 4000 K	N ON/OFF	B Black 03
LW1	70	DI	10	SP	30	N	B



CARACTERÍSTICAS TÉCNICAS

Ópticas

AS

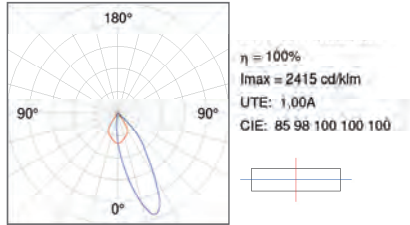

SP 10°-16°

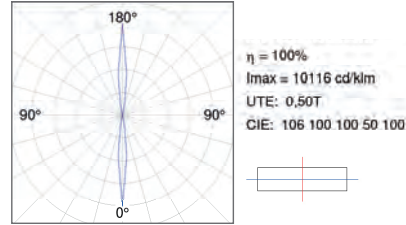

MFL 38°

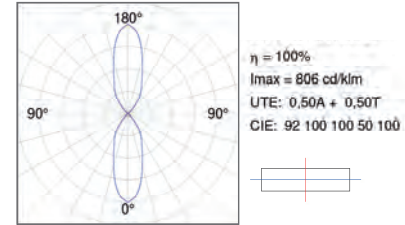

WFL 53°-60°

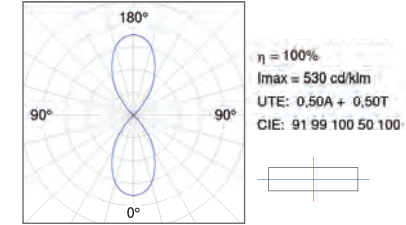

Flujo de salida y potencia

LUP Ø70

		1300lm			
		K	CRI	W	lm Output
DIR	ASYM	3000	80	10,6	665
		4000	80	10,6	705
		650+650lm			
		K	CRI	W	lm Output
DIR-IND	SP	3000	80	12,4	863
	10°	4000	80	12,4	928
	MFL	3000	80	10,1	1011
	38°	4000	80	10,1	1072
	WFL	3000	80	10,1	1031
	60°	4000	80	10,1	1093

LUP Ø110

		3000lm			
		K	CRI	W	lm Output
DIR	ASYM	4000	80	25,8	1295
		2000+2000lm			
		K	CRI	W	lm Output
DIR-IND	SP	4000	80	37,2	2510
	16°				
	MFL	4000	80	30,8	2706
	32°				
	WFL	4000	80	30,8	2748
	53°				



Lup Downlight Ø110



Lup Downlight Ø162

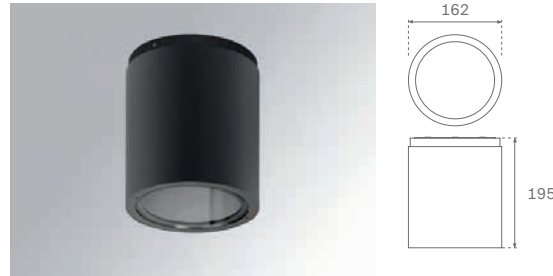

LUP DOWNLIGHT

Familia	Diámetro	Lm LED	Óptica	K	Equipo	Acabados
LS1	110 Ø110mm	05 900lm	FL FL 34°	30 3000 K	N ON/OFF	B Black 03
		10 1300lm	WF WFL 54°	40 4000 K		
	162 Ø162mm	30 3000lm	FL FL 30°	40 4000 K	N ON/OFF	B Black 03
		40 4000lm	WF WFL 71°			
LS1	110	05	FL	30	N	B

CARACTERÍSTICAS TÉCNICAS

Flujo de salida y potencia

LUP Ø110

	K	CRI	900lm		1300lm	
			W	lm Output	W	lm Output
FL 34°	3000	80	6,3	600	9,7	963
	4000	80	6,3	626	9,7	1003
WFL 54°	3000	80	6,3	624	9,7	1008
	4000	80	6,3	650	9,7	1080

LUP Ø162

	K	CRI	3000lm		4000lm	
			W	lm Output	W	lm Output
FL 30°	4000	80	25,9	2162	33,9	2850
	4000	80	25,9	2392	33,9	3114



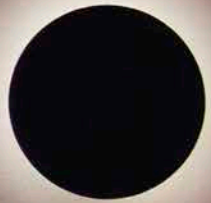

Mun Dark IP65

Mun Dark IP65
140

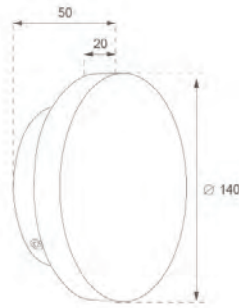

Mun Dark IP65
200

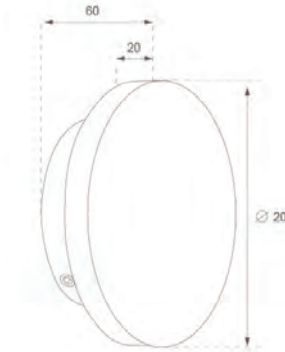

MUN DARK IP65

Familia	Instalación	Formato	Lm LED	IP	IRC	K	Equipo	Acabados
MD1	SF Surface	140 140mm 200 200mm	01 100lm	65 IP65	8 80	30 3000 K	N ON/OF	B Black 05 W White
MD1	SF	140	01	65	8	30	N	B

CARACTERÍSTICAS TÉCNICAS

MUN DARK IP65

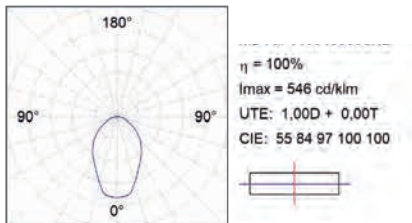

MUN DARK IP65

	K	CRI	140lm		200lm	
			W	lm Output	W	lm Output
WH	3000	80	6,8	440	9,1	630
BK				370		540



Niu

Niu
Symmetric

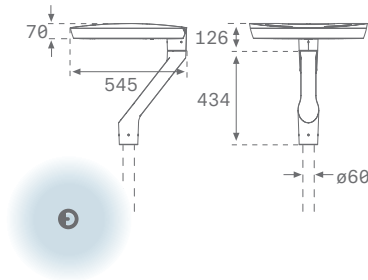

Niu
Street

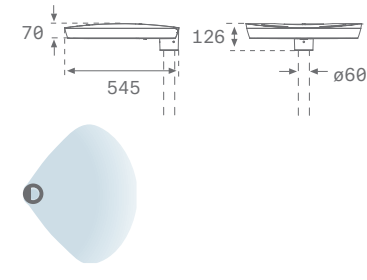

NIU

Familia	Lm LED	Clase	Óptica	IRC	K	Equipo	Acabados
NI1	45 4500lm	1 I	SY Symmetric	7 70	40 4000 K	N ON/OF	G Grey 03
	90 9000lm	2 II	ST Street				
NI1	45	1	SY	7	40	N	G

CARACTERÍSTICAS TÉCNICAS

Ópticas

SY

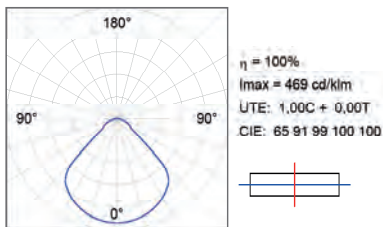

ST

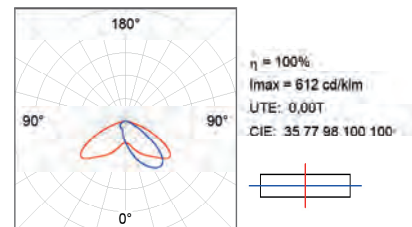

Flujo de salida y potencia

NIU

	K	CRI	4500lm		9000lm	
			W	lm Output	W	lm Output
SY	4000	70	52	4068	104	8013
ST	4000	70	52	3439	104	6737

STREET



ACCESORIOS

Brazo Final ø60mm



Ref.
NIARED60G

Brazo a pared



Ref.
NIAR650G

Abrazadera columna 60-135mm



Ref.
NIPOBR135G

Adaptador columnas ø76mm



Ref.
NIPOAD76G

Soporte a báculo



Ref.
NIPOBR48G ø48mm
NIPOBR60G ø60mm



Owl

Owl
Street

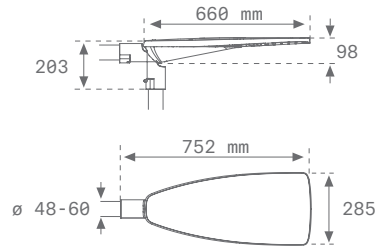

OWL

Familia	Lm LED	Clase	Óptica	IRC	K	Equipo	Acabados
OW1	05 4800lm	1 I	ST Street	8 80	40 4000 K 30 3000 K	N ON/OFF	G Grey 03
	09 8500lm	1 I 2 II					
	13 12500lm	1 I 2 II					
	18 17500lm	1 I 2 II					
OW1	05	1	ST	8	40	N	G



CARACTERÍSTICAS TÉCNICAS

Ópticas

ST

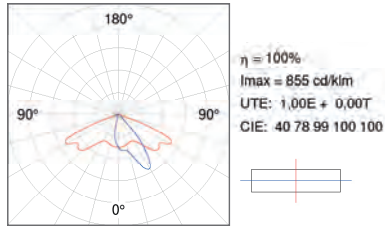

Flujo de salida y potencia

OWL

	K	CRI	4800lm		8500lm		12500lm		17500lm	
			W	lm Output	W	lm Output	W	lm Output	W	lm Output
ST	3000	80	37,6	3871	68	7789	103	11228	135	14762
	4000	80	37,6	3871	68	7789	103	11228	135	14762

ACCESORIOS

Brazo a pared OWL

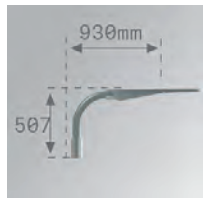

Ref.
OWAR1000G

Posibilidad de otras ópticas



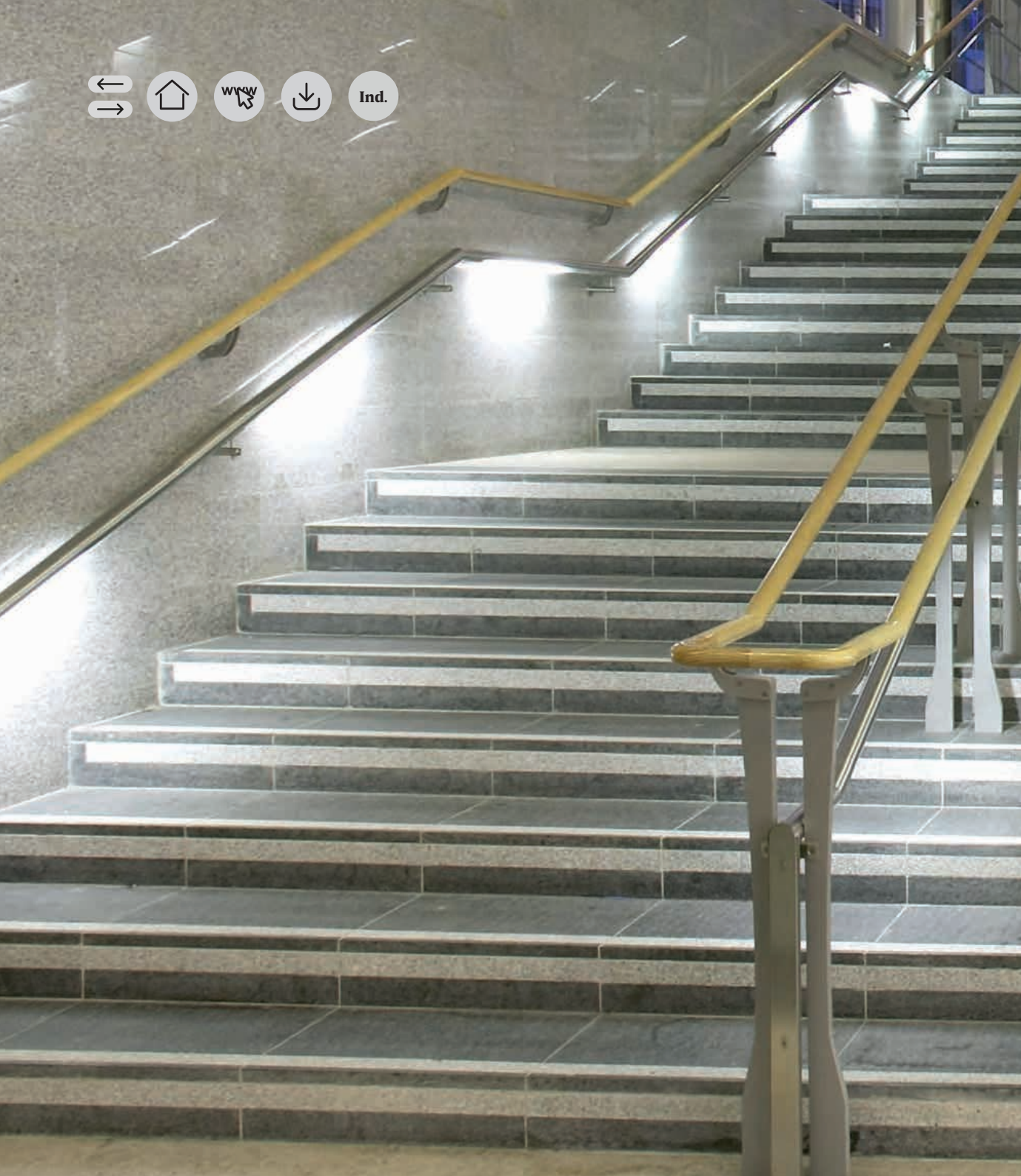

Puck



Puck

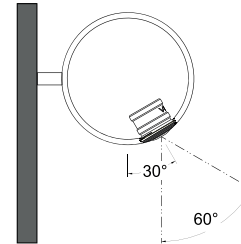
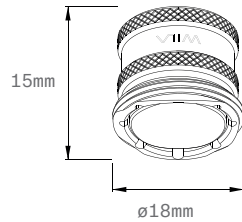

Distribución Simétrica (ONE SIDED)



MP1201501

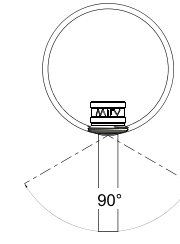

Distribución Doble Simétrica (DBL SIDED)

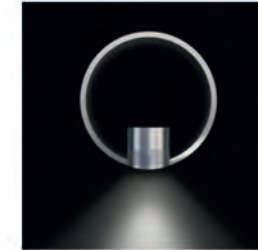

MP1201503

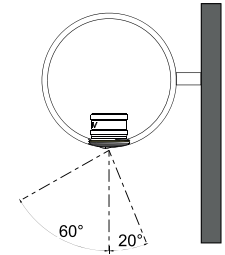

Distribución Asimétrica (ASYM)



MP1201505

Ref.	Descripción
MP1201501-70-30	PUCK XT 3000K ONE SIDED 1.5W
MP1201501-70-40	PUCK XT 4000K ONE SIDED 1.5W
MP1201503-70-30	PUCK XT 3000K DBL SIDED 1.5W
MP1201503-70-40	PUCK XT 4000K DBL SIDED 1.5W
MP1201505-70-30	PUCK XT ASYM 3000K 1.5W
MP1201505-70-40	PUCK XT ASYM 4000K 1.5W

ACCESORIOS

Ref.	Descripción
MP-002	Alicates/herramientas de engaste de discos
MP-003	Conectores de gel (2 necesarios por disco)
MP-004	Loctite 243 botella de 10ml
MP-011	Herramienta de inserción puck xt



MP-011



Vista instalación



CARACTERÍSTICAS TÉCNICAS

Ópticas

Symmetric-Double Symmetric

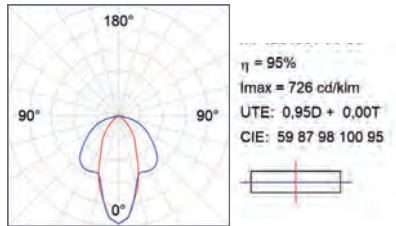

Asymmetric

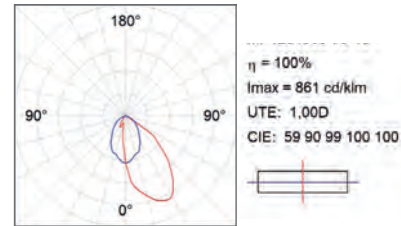

Flujo de salida y potencia

	K	CRI	W	Im Output
One-sided Beam	3000	80	1,5	169
	4000	80	1,5	177
Double-sided Beam	3000	80	1,5	170
	4000	80	1,5	185
Asymmetric	3000	80	1,5	159
	4000	80	1,5	169



Seti



Seti
Soft 500

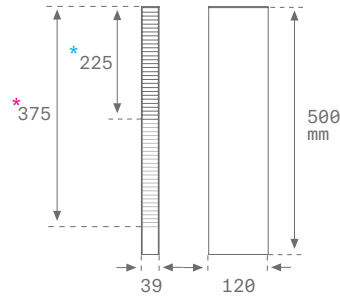

SETI SOFT 500

Familia	Dimensión	Formato	Lm LED	Óptica	IRC	K	Equipo	Acabados Ext.	Acabados
SE1	050 500mm	I Individual*	02 200lm	S0 Soft	8 80	30 3000 K	N ON/OFF	B Black 03	W White
		D Double*	03 300lm	A Anthracite 01				B Black	
SE1	050	I	02	S0	8	30	N	B	W

CARACTERÍSTICAS TÉCNICAS

Ópticas

SOFT 500 INDIVIDUAL

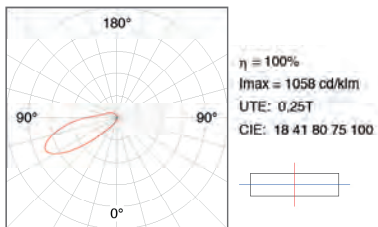

SOFT 500 DOUBLE

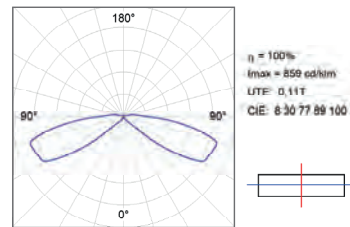

Flujo de salida y potencia

SOFT 500

		200lm			
Format	Color	K	CRI	W	lm Output
IN	B/W	3000	80	3,4	41
	A/B	3000	80	3,4	20
		300lm			
Format	Color	K	CRI	W	lm Output
DB	B/W	3000	80	3,9	49
	A/B	3000	80	3,9	28





Seti
Soft 900

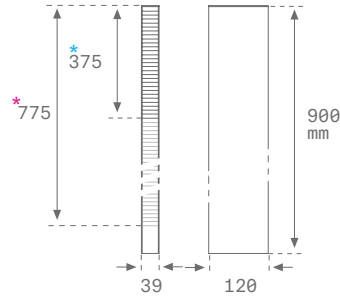

SETI SOFT 900

Familia	Dimensión	Formato	Lm LED	Óptica	IRC	K	Equipo	Acabados Ext.	Acabados
SE1	090 900mm	I Individual* D Double*	05 500lm	S0 Soft	8 80	30 3000 K	N ON/OFF	B Black 03 A Anthracite 01	W White B Black
SE1	090	I	05	S0	8	30	N	B	W

CARACTERÍSTICAS TÉCNICAS

Ópticas

SOFT 900 INDIVIDUAL

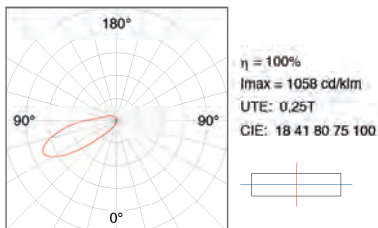

SOFT 900 DOUBLE

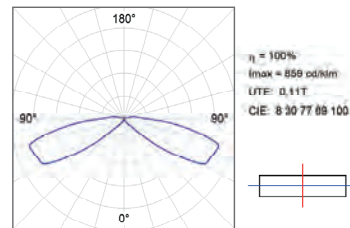

Flujo de salida y potencia

SOFT 900

Format	Color	K	CRI	500lm	
				W	lm Output
IN	B/W	3000	80	6,8	87
	A/B	3000	80	6,8	43
DB	B/W	3000	80	6,4	86
	A/B	3000	80	6,4	49





Seti
Soft 1200

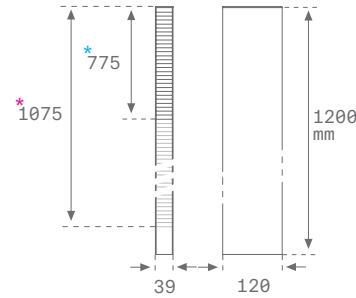

SETI SOFT 1200

Familia	Dimensión	Formato	Lm LED	Óptica	IRC	K	Equipo	Acabados Ext.	Acabados
SE1	120 1200mm	I Individual*	07 700lm	S0 Soft	8 80	30 3000 K	N ON/OFF	B Black 03	W White
		D Double*	10 1000lm	A Anthracite 01				B Black	
SE1	120	I	07	S0	8	30	N	B	W

CARACTERÍSTICAS TÉCNICAS

Ópticas

SOFT 1200 INDIVIDUAL

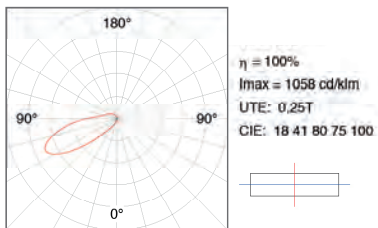

SOFT 1200 DOUBLE

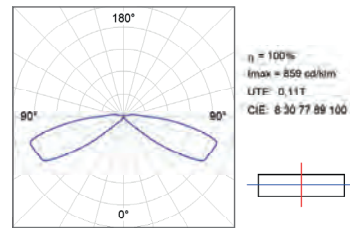

Flujo de salida y potencia

SOFT 1200

		700lm			
Format	Color	K	CRI	W	lm Output
IN	B/W	3000	80	9,4	116
	A/B	3000	80	9,4	92
		1000lm			
Format	Color	K	CRI	W	lm Output
DB	B/W	3000	80	13	185
	A/B	3000	80	13	106





Seti
Spot 500

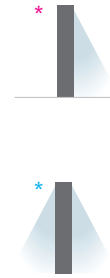
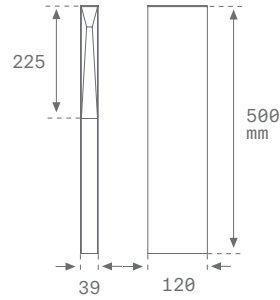

SETI SPOT 500

Familia	Dimensión	Formato	Lm LED	Óptica	IRC	K	Equipo	Acabados Ext.	Acabados
SE1	050 500mm	I Individual*	02 200lm	SP Spot	8 80	30 3000 K	N ON/OFF	B Black 03	W White
		D Double*	03 300lm					A Anthracite 01	B Black
SE1	050	I	02	SP	8	30	N	B	W

CARACTERÍSTICAS TÉCNICAS

Ópticas

SPOT 500 INDIVIDUAL

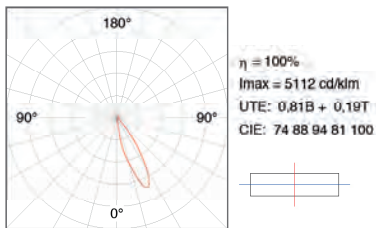

SPOT 500 DOUBLE

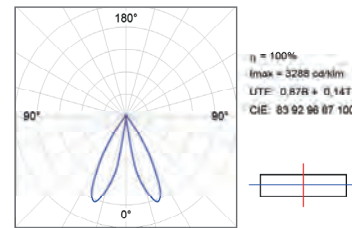

Flujo de salida y potencia

SPOT 500

Format	Color	K	CRI	200lm	
				W	lm Output
IN	B/W	3000	80	4,7	107
	A/B	3000	80	4,7	80
300lm					
DB	Color	K	CRI	300lm	
				W	lm Output
DB	B/W	3000	80	9,2	261
	A/B	3000	80	9,2	195





Seti
Spot 900

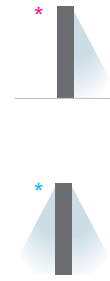
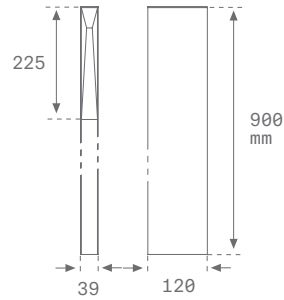

SETI SPOT 900

Familia	Dimensión	Formato	Lm LED	Óptica	IRC	K	Equipo	Acabados Ext.	Acabados
SE1	090 900mm	I Individual*	05 500lm	SP Spot	8 80	30 3000 K	N ON/OFF	B Black 03	W White
		D Double*	05 500lm	A Anthracite 01				B Black	
SE1	090	I	05	SP	8	30	N	B	W

CARACTERÍSTICAS TÉCNICAS

Ópticas

SPOT 900 INDIVIDUAL

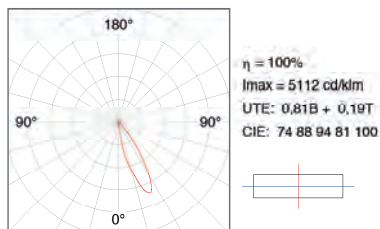

SPOT 900 DOUBLE

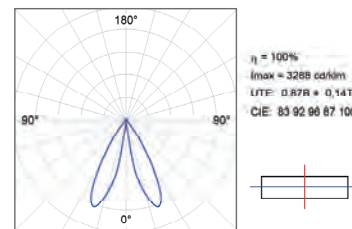

Flujo de salida y potencia

SPOT 900

Format	Color	K	CRI	200lm	
				W	lm Output
IN	B/W	3000	80	4,7	130
	A/B	3000	80	4,7	97
				300lm	
DB	Color	K	CRI	W	lm Output
				B/W	3000
	A/B	3000	80	9,2	195





Seti
Spot 1200

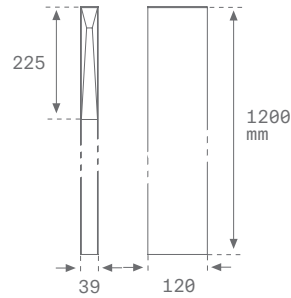

SETI SPOT 1200

Familia	Dimensión	Formato	Lm LED	Óptica	IRC	K	Equipo	Acabados Ext.	Acabados
SE1	120 1200mm	I Individual*	07 700lm	SP Spot	8 80	30 3000 K	N ON/OFF	B Black	W White
		D Double*	10 1000lm	A Anthracite				B Black	
SE1	120	I	07	SP	8	30	N	B	W

CARACTERÍSTICAS TÉCNICAS

Ópticas

SPOT 1200 INDIVIDUAL

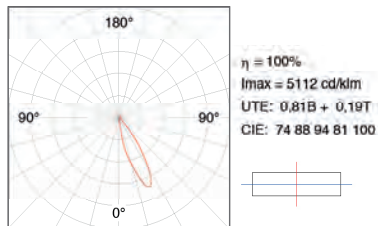

SPOT 1200 DOUBLE

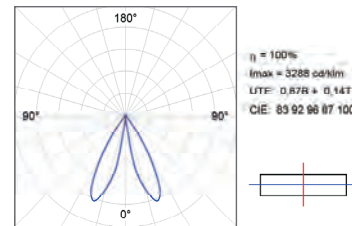

Flujo de salida y potencia

SPOT 1200

Format	Color	K	CRI	200lm	
				W	lm Output
IN	B/W	3000	80	4,7	130
	A/B	3000	80	4,7	97
				300lm	
Format	Color	K	CRI	W	lm Output
				W	lm Output
DB	B/W	3000	80	9,2	261
	A/B	3000	80	9,2	195





Shot



Shot 80
ON/OFF

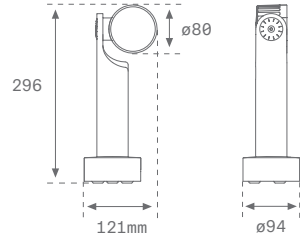

Shot 80
NO GEAR

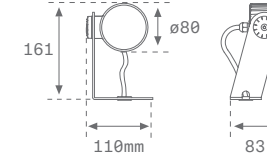
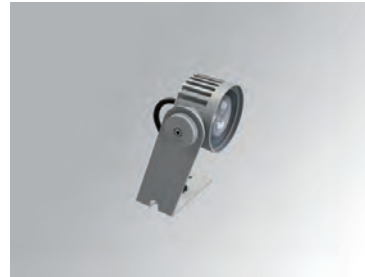

Ref: [DRV6721700N](#)

SHOT 80

Familia	Lm LED	Óptica	IRC	K	Equipo	Acabados
MC2	09 900lm	SP SP 19° MF MFL 28°	8 80	30 3000 K 40 4000 K	N ON/OFF O NO GEAR	G Grey 03 A Anthracite 01
MC2	09	SP	8	30	N	G

CARACTERÍSTICAS TÉCNICAS

Ópticas

SP 19°

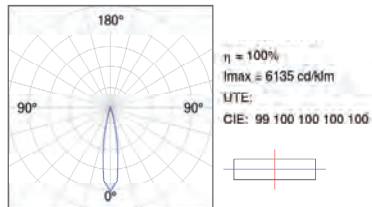

MF 28°

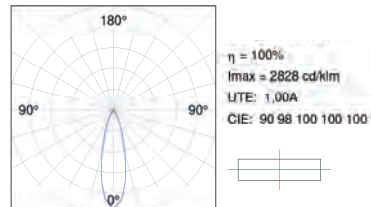

Flujo de salida y potencia

SHOT 80

	900lm			
	K	CRI	W	lm Output
SP	3000	80	9,4	720
19°	4000	80	9,4	720
MFL	3000	80	9,4	609
28°	4000	80	9,4	609



ACCESORIOS



PRESENTACIÓN FAMILIA



Visera antideslumbrante



Ref.

MCSC82B

Color



Estoque

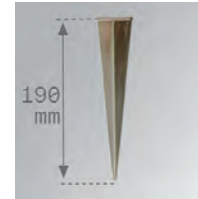

Ref.

MCSPM ●

Color



- Tratamiento anticorrosivo bicromatado



Shot 120

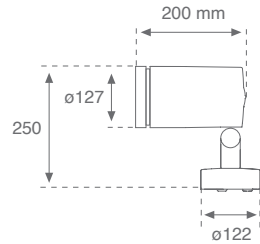

Shot 120 Bracket

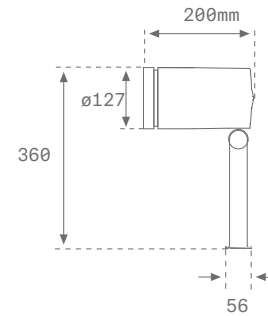

Shot 120 Pole

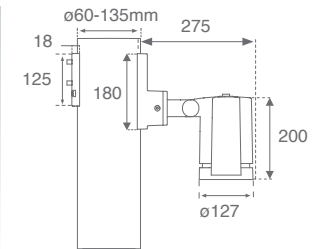

SHOT 120

Familia	Lm LED	Óptica	IRC	K	Equipo	Acabados
MN2	15 1500lm	SP SP 11°	8 80	30 3000 K	N ON/OFF	G Grey 03
	30 2900lm	MF MFL 24°				A Anthracite 01
	40 3800lm					
MN2	15	SP	8	30	N	G

SHOT 120 BRACKET

Familia	Instalación	Lm LED	Óptica	IRC	K	Equipo	Acabados
MN2	BR Bracket	15 1500lm	SP SP 11°	8 80	30 3000 K	N ON/OFF	G Grey 03
		30 2900lm	MF MFL 24°				A Anthracite 01
		40 3800lm					
MN2	BR	15	SP	8	30	N	G

SHOT 120 POLE

Familia	Instalación	Lm LED	Óptica	IRC	K	Equipo	Acabados
MN2	BJ Pole	15 1500lm	SP SP 11°	8 80	30 3000 K	N ON/OFF	G Grey 03
		30 2900lm	MF MFL 24°				A Anthracite 01
		40 3800lm					
MN2	BJ	15	SP	8	30	N	G



CARACTERÍSTICAS TÉCNICAS

Ópticas

SP 11°

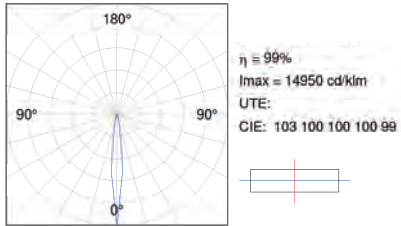

MFL 24°

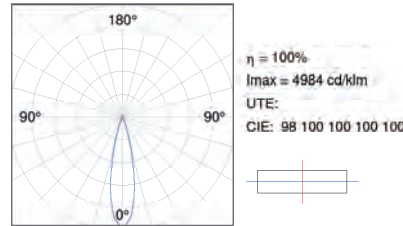

Flujo de salida y potencia

SHOT 120

	K	CRI	1500lm		2900lm		3800lm	
			W	lm Output	W	lm Output	W	lm Output
SP	3000	80	13,2	1146	23	2215	33,5	3032
11°	4000	80	13,2	1146	23	2215	33,5	3032
MFL	3000	80	13,2	1097	23	2155	33,5	2937
24°	4000	80	13,2	1097	23	2155	33,5	2937



ACCESORIOS

Columna en aluminio (60x60 mm)

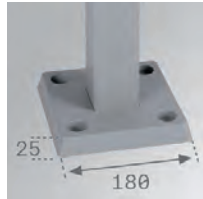

Lm	Ref.	Color	Fig.	Minishot	Pict.
1	MSP01000G	●	1/2	1 o 2	
1	MSP01000A	●	1/2	1 o 2	
2,5	MSP02500G	●	3/4	1 o 2	
2,5	MSP02500A	●	3/4	1 o 2	

Plantilla fijación anclaje columna

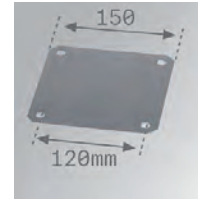

Ref.	Color
MSFTSQG	●

Anclaje para hormigón M8



Ref.	Color
MSFIC	●

Soporte pared 1m

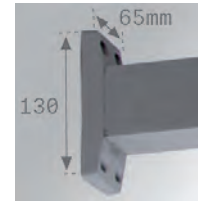

Ref.	Color	Fig.
MSAR1000G	●	5
MSAR1000A	●	5

● Tratamiento anticorrosivo bicromatado

Estoque

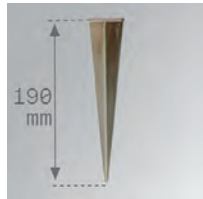

Ref.	Color	Fig.
MSSPM ●	●	6

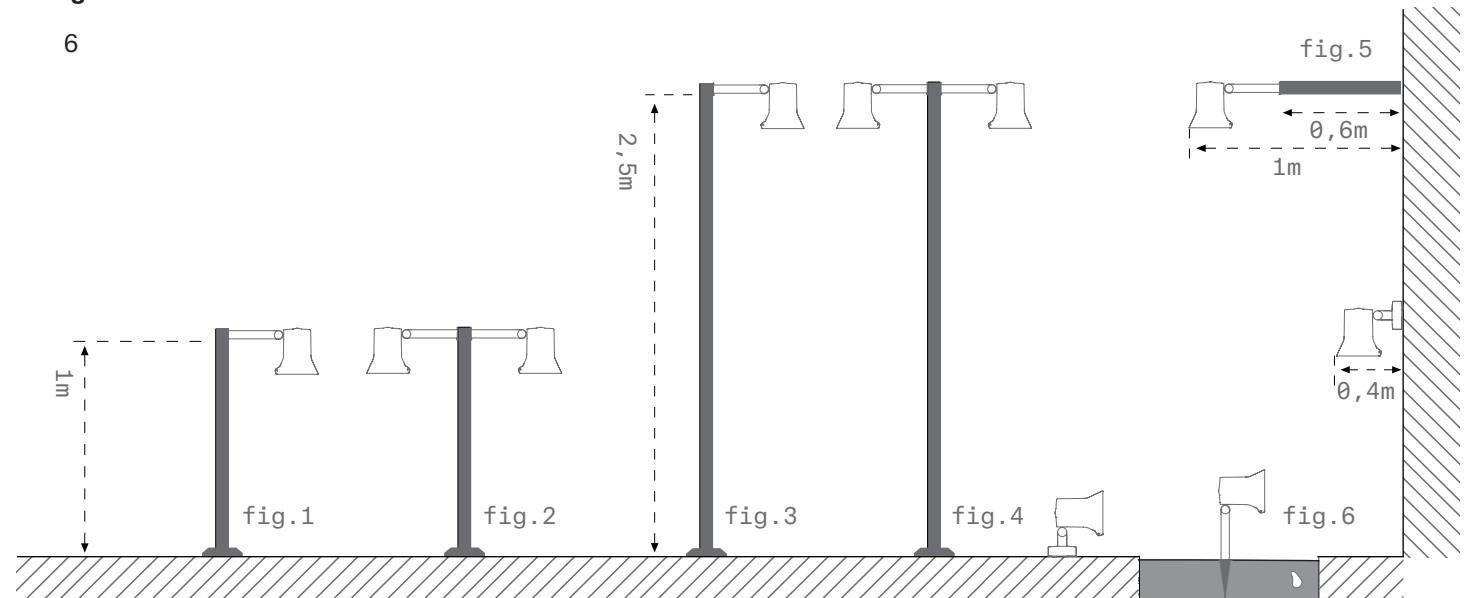



Shot 180
SP/MFL



Shot 180
Street

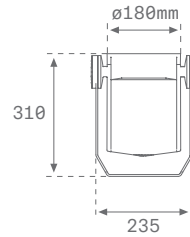

SHOT 180

Familia	Lm LED	Óptica	IRC	K	Equipo	Acabados
SH2	50 5000lm	SP SP 11°	8 80	30 3000 K	N ON/OFF	G Grey 03
	70 7200lm	MF MFL 23°-24°				A Anthracite 01
	50 5000lm	ST STREET	8 80	40 4000 K	N ON/OFF	G Grey 03
	70 7200lm					A Anthracite 01
SH2	50	SP	8	30	N	G

CARACTERÍSTICAS TÉCNICAS

Ópticas

SP 11°

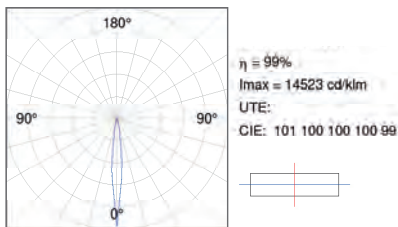

MFL 23°-24°

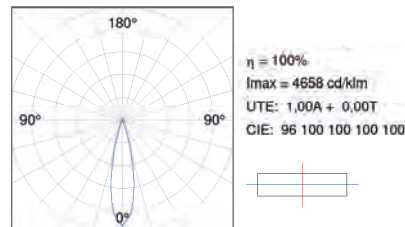

STREET

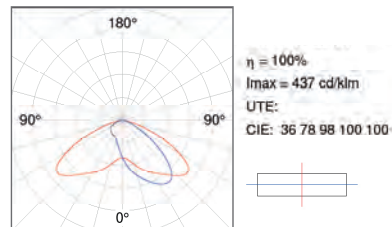

Flujo de salida y potencia

SHOT 180

	K	CRI	5000lm		7200lm	
			W	lm Output	W	lm Output
SP 11°	3000	80	41	4127	61,2	5419
	4000	80	41	4127	61,2	5419
MFL 24°	3000	80	41	4112	61,2	5396
	4000	80	41	4112	61,2	5396
ST	4000	80	41	3850	61,2	5050





ACCESORIOS

Visera antideslumbrante



Ref.	Color
SHSC184B	●

Sistema Shot LED

Abrazadera de aluminio SHOT / FLUT para columna ø120-130 mm



	Ref.	Color
1 spot	COARIN120G	●
1 spot	COARIN120A	●
2 spot	COARDB120G	●
2 spot	COARDB120A	●

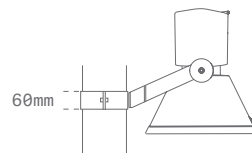

Soporte fijación SHOT / FLUT de aluminio para columna ø60-135 mm



	Ref.	Color
1 spot	COARIN060G	●
1 spot	COARIN060A	●

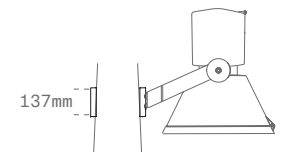



Shot 290

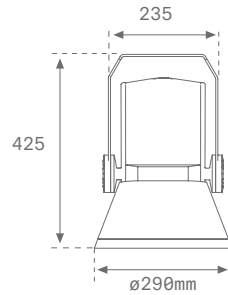

Shot 380

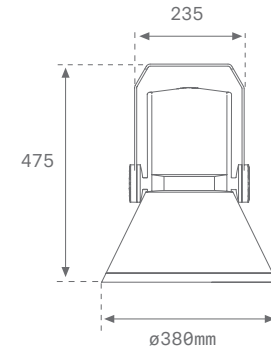

SHOT 290

Familia	Formato	Lm LED	Óptica	IRC	K	Equipo	Acabados
SH3	29 ø290	65	5500lm	SP	8 80	N ON/OFF	G Grey 03 A Anthracite 01
		80	8000lm	MFL			
				VWF			
				ST STREET			
SH3	29	07	SP	8	30	N	G

SHOT 380

Familia	Formato	Lm LED	Óptica	IRC	K	Equipo	Acabados
SH3	38 ø380	07	7000lm	SP	8 80	N ON/OFF	G Grey 03 A Anthracite 01
		08	8000lm	MFL			
		10	10000lm	VWF			
				ST STREET			
SH3	38	07	SP	8	30	N	G

STREET



CARACTERÍSTICAS TÉCNICAS

Ópticas

SP

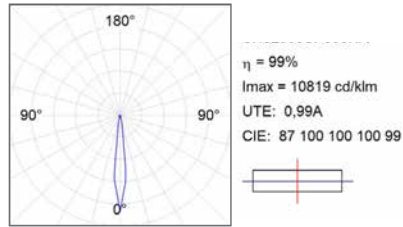

MFL

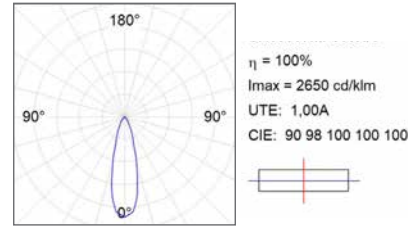

VWFL

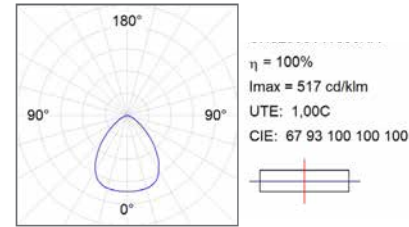

ST

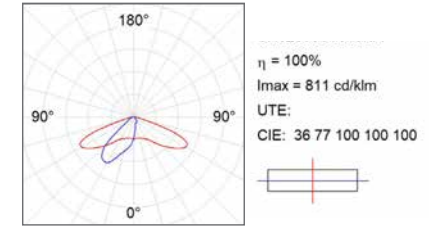

Flujo de salida y potencia

SHOT 290

	K	CRI	5500lm	
			W	lm Output
SP	3000	80	48	4220
	4000	80	48	4541
MFL	3000	80	48	4757
	4000	80	48	5063
VWFL	3000	80	48	4868
	4000	80	48	5181
ST	3000	80	48	4349
	4000	80	48	4629

SHOT 380

	K	CRI	7000lm		10000lm	
			W	lm Output	W	lm Output
SP	3000	80	51,1	5148	82,5	7257
	4000	80	51,1	5539	82,5	7809
MFL	3000	80	51,1	5703	82,5	8213
	4000	80	51,1	6071	82,5	8743
VWFL	3000	80	51,1	5836	82,5	8405
	4000	80	51,1	6213	82,5	8947
ST	3000	80	51,1	5214	82,5	7509
	4000	80	51,1	5550	82,5	7993

ACCESORIOS

Antideslumbrante circular 290

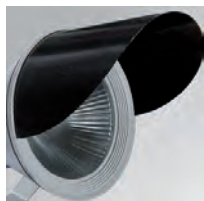

Ref. Color

SH29SC297B ●

● No compatible modelos vial

Antideslumbrante circular 380

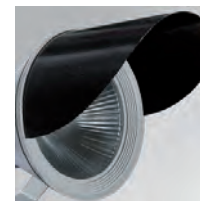

Ref. Color

SH38SC381B ●

● No compatible modelos vial



Trace IP65



Trace IP65
100 Symmetric

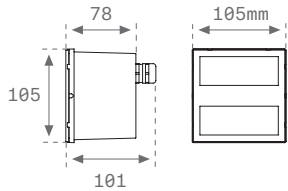

Trace IP65
200 Asymmetric

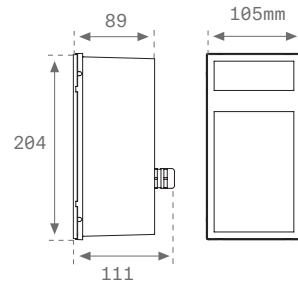

Trace IP65
200 Asymmetric

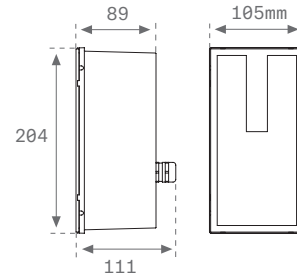

Trace IP65
200 Symmetric

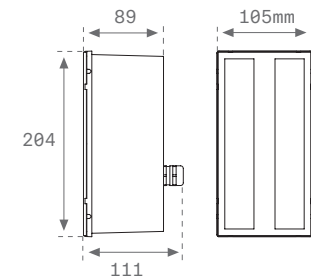

TRACE IP65 100 SY

Familia	Dimensión	Formato	Lm LED	IP	Óptica	IRC	K	Equipo	Acabados
TC1	10 100mm	H Horizontal	01 150lm	65 65	SY Symmetric	8 80	30 3000 K	N ON/OFF	B Black 07
TC1	10	H	01	65	SY	8	30	N	B

TRACE IP65 200 AS

Familia	Dimensión	Formato	Lm LED	IP	Óptica	IRC	K	Equipo	Acabados
TC1	20 200mm	H Horizontal V Vertical	02 150lm	65 65	AS Asymmetric	8 80	30 3000 K	N ON/OFF	B Black 07
TC1	20	H	02	65	AS	8	30	N	B

TRACE IP65 200 SY

Familia	Dimensión	Formato	Lm LED	IP	Óptica	IRC	K	Equipo	Acabados
TC1	20 200mm	V Vertical	02 300lm	65 65	SY Symmetric	8 80	30 3000 K	N ON/OFF	B Black 07
TC1	20	V	02	65	SY	8	30	N	B

● **Accesorio obligatorio**





CARACTERÍSTICAS TÉCNICAS

Ópticas

100 SY

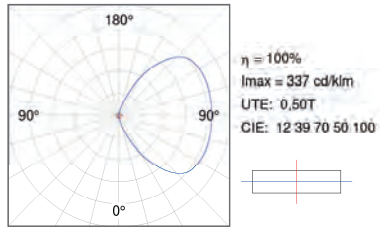

200 AS H

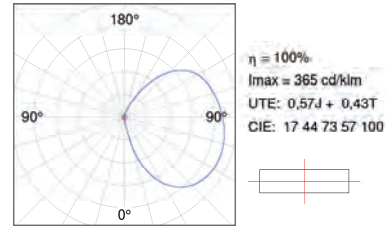

200 AS V

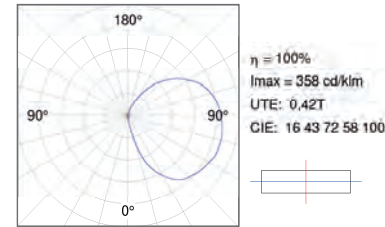

200 SY

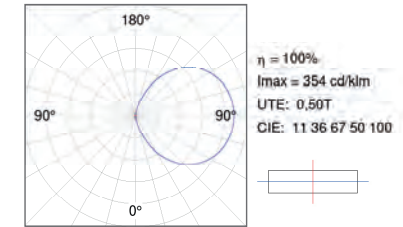

Flujo de salida y potencia

100 SY

	150lm			
	K	CRI	W	lm Output
SY	3000	80	2,7	68

200 AS H/V

	150lm			
	K	CRI	W	lm Output
AS H	3000	80	2,7	92
AS V	3000	80	2,7	94

200 SY

	300lm			
	K	CRI	W	lm Output
SY	3000	80	4,1	156

ACCESORIOS

Caja empotramiento TRACE 65 100



Ref.
TCREB065100

Color
●

Caja empotramiento TRACE 65 200



Ref.
TCREB065200

Color
●



Urban 100

Urban 100

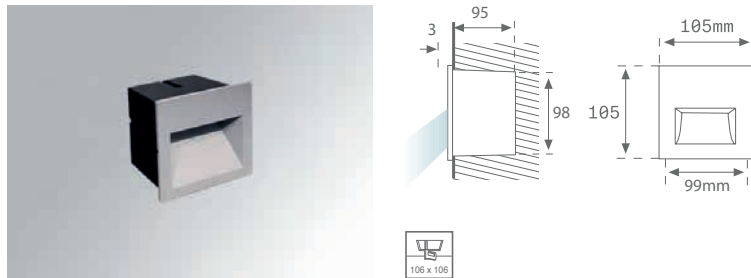

URBAN 100

Familia	Formatos	Lm LED	IP	Óptica	IRC	K	Equipo	Acabados
UR1	SQ Square	04 400lm	AS Asymmetric	65 65	9 90	27 2700 K 40 4000 K	N ON/OFF	G Grey 03
UR1	SQ	04	AS	65	9	27	N	G

CARACTERÍSTICAS TÉCNICAS

Ópticas

URBAN 100

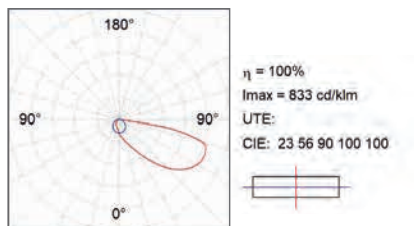

Flujo de salida y potencia

URBAN 100

400lm			
K	CRI	W	lm Output
2700	90	1,7	113
4000	90	1,7	113





Xtrema

Xtrema
40

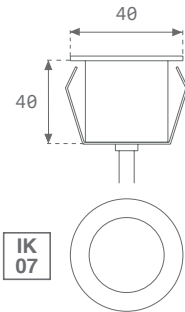

Xtrema
60

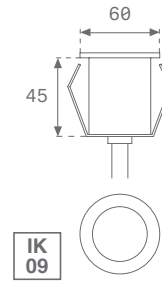

XTREMA

Familia	Formato	Lm LED	IP	Óptica	IRC	K	Equipo CV 24V	Acabados
XT2	40 40mm	01 100lm	67 IP67	WF WFL	8 80	30 3000 K 40 4000 K	0 ● Not Included	I Inox
	60 60mm	03 300lm						
XT2	40	01	67	WF	8	30	0	I

● Driver 24V

CARACTERÍSTICAS TÉCNICAS

Ópticas

XTREMA 40

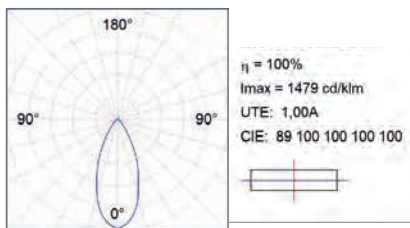

XTREMA 60

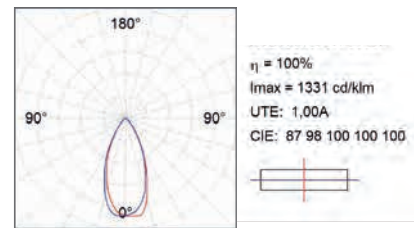

Flujo de salida y potencia

XTREMA

K	CRI	100lm		300lm	
		W	lm Output	W	lm Output
3000	80	1	85	3	174
4000	80	1	85	3	174



ACCESORIOS

Caja empotramiento Xtrema 40

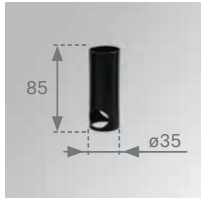

Ref.
X4B036B

Caja empotramiento Xtrema 60

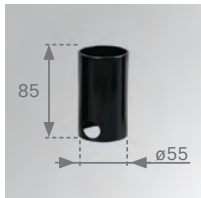

Ref.
X6B056B

Conectores 4 polos IP67



Ref.
CT4P67N

Driver IP67



Ref.
DRV6710024N
DRV6710024D



General Acc. Outdoor

SISTEMA VIAL

Brazo final ind vidual corto Shot/Flut



Ref.	Color	ømm	fig.
COARSHIN60G	●	60	1
COARSHIN60A	●	60	1
COARSHIN76G	●	76	1
COARSHIN76A	●	76	1

Brazo final ind vidual largo Shot/Flut



Ref.	Color	ømm	fig.
COARLOIN60G	●	60	3
COARLOIN60A	●	60	3
COARLOIN76G	●	76	3
COARLOIN76A	●	76	3

Brazo final doble orto Shot/Flut



Ref.	Color	ømm	fig.
COARSHDB60G	●	60	2
COARSHDB60A	●	60	2
COARSHDB76G	●	76	2
COARSHDB76A	●	76	2

Brazo final doble largo Shot/Flut



Ref.	Color	ømm	fig.
COARLODB60G	●	60	4
COARLODB60A	●	60	4
COARLODB76G	●	76	4
COARLODB76A	●	76	4

Brazo intermedio individual corto Shot/Flut



Ref.	Color	ømm	fig.
COARSHINT080G	●	min. 80	5
COARSHINT080A	●	max. 120	5

Brazo intermedio individual largo Shot/Flut



Ref.	Color	ømm	fig.
COARLOINT080G	●	min. 80	6
COARLOINT080A	●	max. 120	6

Brazo pared largo Shot/Flut



Ref.	Color	ømm	fig.
FXARWAG	●	0,8	8
FXARWAA	●	0,8	8

● Esquema P 405

SISTEMA VIAL

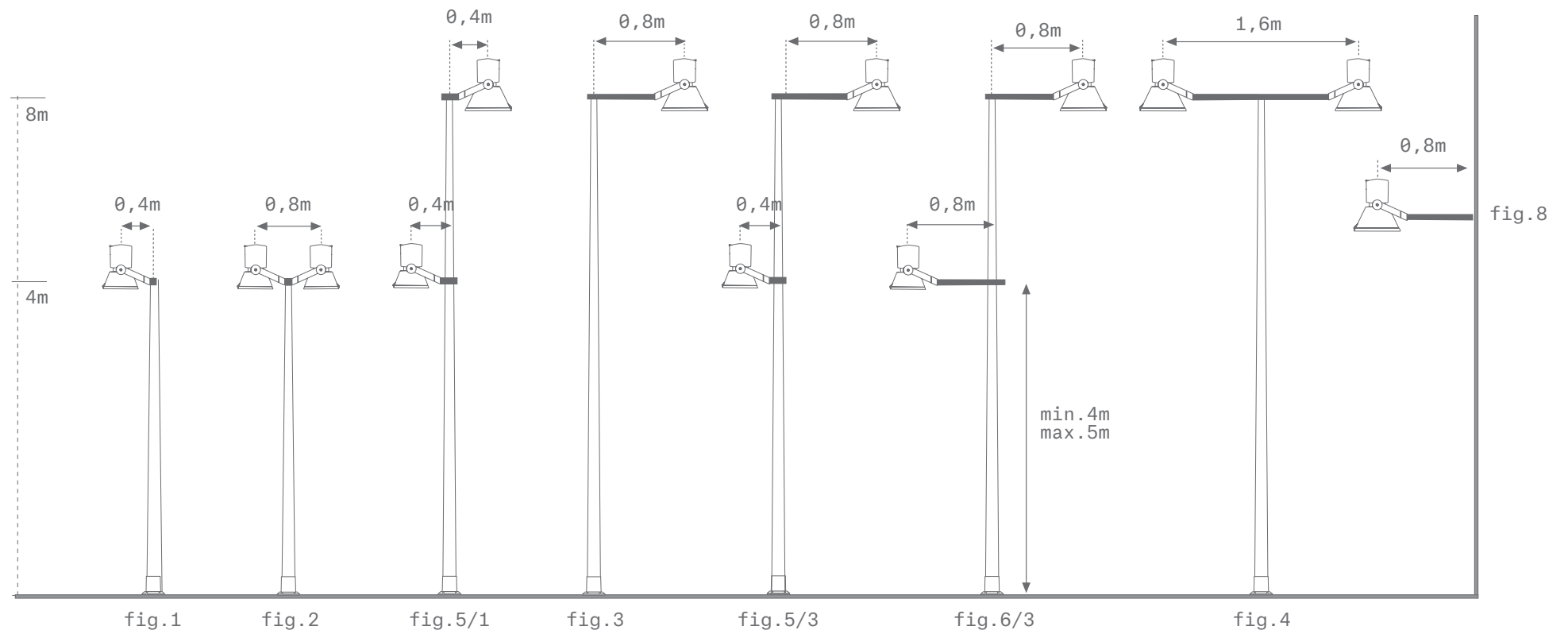



ILUMINACIÓN EN LUGARES DE TRABAJO SEGÚN NORMA UNE - EN 12464-1

TIPO DE ACTIVIDAD	LUX	UGRL	Ra
OFICINAS			
Archivo, copias	300	19	80
Escritura, máquina de escribir, lectura, trat. Datos	500	19	80
Dibujo técnico	750	19	80
Puestos de trabajo en CAD	500	19	80
Salas de conferencias y reuniones	500	19	80
Mostrador de recepción	300	22	80
ESTABLECIMIENTOS MINORISTAS			
Área de ventas	300	22	80
Área de cajas	500	19	80
Mesa de envolver	500	19	80
LUGARES DE PÚBLICA CONCURRENCIA			
Áreas comunes			
Halls de entrada	100	22	80
Guardarropias	200	25	80
Salones	200	22	80
Oficinas de taquillas	300	22	80
Restaurantes y hoteles			
Recepción caja y conserjería	300	22	80
Cocinas	500	25	80
Restaurante, comedor y salas de reuniones	-	-	80
Salas de conferencias	500	19	80
Pasillos	100	25	80

Ferias, pabellones de exposiciones, teatros, salas de cine y de conciertos			
Alumbrado general	300	22	80
Museos			
Obras exhibidas insensibles a la luz	Iluminación determinada por requisitos de la presentación		
Obras exhibidas sensibles a la luz			
Bibliotecas			
Estanterías	200	19	80
Área de lectura	500	19	80
Puestos de servicio público	500	19	80
Aparcamientos de vehículos públicos (interior)			
Rampas de acceso o de salida (de día)	300	25	80
Rampas de acceso o de salida (de noche)	75	25	80
Calles de circulación	75	25	80
Área de aparcamiento	75	-	80
Caja	300	19	80
ACTIVIDADES INDUSTRIALES Y ARTESANALES			
Agricultura			
Carga y operaciones con artículos y maquinaria	200	25	80
Edificios para ganadería	50	-	40
Sala de veterinaria, establos para parir	200	25	80
Cemento, artículos de cemento, hormigón, ladrillos			
Secado	50	28	20
Preparación de materiales, trabajo en hornos y mezcladores	200	28	40
Trabajo de máquinas en general, encofrado	300	25	80

TIPO DE ACTIVIDAD	LUX	UGR _L	R _a
Cerámicas, tejas, vidrio			
Secado	50	28	20
Preparación, trabajo en máquinas en general	300	25	80
Esmaltado, laminado, prensado, horneado	300	22	80
Amolado, grabado, pulido	750	19	80
Amolado de vidrio óptico	750	19	80
Trabajo de precisión	1000	16	90
Fabricación de piedras preciosas	1500	16	90
Industria química de plásticos y caucho			
Instalaciones de tratamiento con control remoto	50	-	20
Instalaciones de tratamiento con control manual	150	28	40
Puestos de trabajo protegidos en instalaciones	300	25	80
Salas de medida de precisión, laboratorios	500	19	80
Producción farmacéutica y de neumáticos	500	22	80
Inspección de colores	1000	16	90
Cort, acabado, inspección	750	19	80
Industria eléctrica			
Fabricación de cable e hilos, bobinas grandes	300	25	80
Bobinas pequeñas	750	19	80
Impregnación de bobinas y galvanización	300	25	80
Trabajo de ensamblaje bajo (transformadores)	300	25	80
Trabajo de ensamblaje medio (cuadro contador)	500	22	80
Trabajo de ensamblaje fino (teléfonos)	750	19	80

Trabajo de ensamblaje de precisión (eq. medida)	1000	16	80
Talleres de electrónica	1500	16	80
Productos alimenticios e industria de alimentos de lujo			
Puestos de trabajo, fábrica de cerveza	200	25	80
Puestos de trabajo para lavado, limpieza	200	25	80
Puestos de trabajo en zonas de cocción	200	25	80
Puestos de trabajo en azucareras	200	25	80
Puestos de trabajo, secar y fermentar tabaco	200	25	80
Clasificación y lavado de productos	300	25	80
Puestos de trabajo, zonas críticas en mataderos	500	25	80
Corte y clasificación de frutas y vegetales	300	25	80
Fabricación de productos delicatessen	500	22	80
Inspección de vidrios y botellas	500	22	80
Laboratorios	500	19	80
Inspección de colores	1000	16	80
Fundiciones y colada de metales			
Fosos, cuevas	50	-	20
Plataformas	100	25	40
Preparación de arena	200	25	80
Vestuarios	200	25	80
Puestos de trabajo, en cúpula y mezclador	200	25	80
Nave de colada, moldeo en máquina	200	25	80
Moldeo a mano y en núcleos y moldeo a presión	300	25	80
Construcción de modelos	500	22	80

TIPO DE ACTIVIDAD	LUX	UGR _L	R _a
Panaderías			
Preparación y hornos de cocción	300	22	80
Acabado, horneado, decoración	500	22	80
Peluquerías			
Trabajo de peluquería	500	19	90
Fabricación de joyas			
Trabajo con piedras preciosas	1500	16	90
Fabricación de joyas	1000	16	90
Relojería manual	1500	16	80
Relojería automática	500	19	80
Lavanderías y limpiezas en seco			
Marcado, clasificación de artículos y lavado	300	25	80
Limpieza en seco, planchado y a vapor	300	25	80
Inspección y reparaciones	750	19	80
Cuero y artículos de cuero			
Trabajo en tintas, barriles y pozos	200	25	40
Limpieza y frotado de pieles	300	25	80
Curtido, fabricación de zapatos	500	22	80
Control de calidad	1000	19	80
Inspección de colores	1000	16	90
Trabajo y tratamiento de metales			
Forja en troquel abierto	200	25	60
Estampación en caliente, soldadura	300	25	60

Fabricación de herramientas	750	19	60
Montaje basto	200	25	80
Montaje medio	300	25	80
Montaje fin	500	22	80
Montaje precisión	750	19	80
Galvanización	300	25	80
Preparación de superficies y pintura	750	25	80
Fabricación de herramientas, micromecánica	1000	19	80
Papel y artículos de papel			
Molino vertical y de pulpa	200	25	80
Fabricación y tratamiento de papel	300	25	80
Encuadernado estándar, plegado, encolado	500	22	80
Centrales de energía eléctrica			
Alojamiento de caldera	100	28	40
Salas de máquinas	200	25	80
Imprentas			
Corte, grabado, tipografía, clichés, impresión	500	19	80
Clasificación de papel e impresión a mano	500	19	80
Ajustes de tipos, retoques, litografía	1000	19	80
Inspección de colores en impresión, multicolor	1500	16	90
Grabado en acero y cobre	2000	16	80
Laminación, instalaciones siderúrgicas			
Instalación de producto no intervención manual	50	-	20
Instalación de producto intervención manual continua	200	25	80



ILUMINACIÓN EN LUGARES DE TRABAJO SEGÚN NORMA UNE - EN 12464-1

TIPO DE ACTIVIDAD	LUX	UGR _L	R _a
Hornos	200	25	20
Tren de laminación, bobinadora	300	25	40
Plataformas de control	300	22	80
Ensayos, medición e inspección	500	22	80
Industria textil			
Puestos de trabajo y servicios	200	25	60
Cardado, planchado, lavado, peinado	300	22	80
Hilado, plegado, enrollado, bobinado, tejido	500	22	80
Cosido, tejido de punto, costuras, patrones	750	22	80
Acabado, teñido	500	22	80
Sala de secado	100	28	60
Impresión automática de tejidos	500	25	80
Inspección de colores, control de tejidos	1000	16	90
Zurcido invisible	1500	19	90
Fabricación de vehículos			
Carrocería y montaje	500	22	80
Pintura, pulverización, pulido	750	22	80
Pintura, retoque, inspección	1000	19	80
Fabricación de tapicería	1000	19	80
Industria maderera y su tratamiento			
Tratamiento automático, secado, fabrica tablero	50	28	40
Tratamientos con vapor	150	28	40
Trabajo en uniones, encolado, montaje	300	25	80

Pulido, pintura, ensamblajes fin s	750	22	80
Tomeado, estriado, enderezado, ranurado	500	19	80
Selección de maderas de placas	750	22	90
Marquetería, incrustación en madera	750	22	90
Control de calidad, inspección	1000	19	90

ESTABLECIMIENTOS EDUCATIVOS

Jardines de infancia, guarderías, edificios educativos

Aulas, aulas de tutoría	300	19	80
Aulas para clases nocturnas y adultos	500	19	80
Aulas de dibujo técnico	750	16	80
Aulas de prácticas, laboratorios, taller enseñar	500	19	80
Aulas de música, informática e idiomas	300	19	80
Aulas de preparación y talleres	500	22	80
Halls de entrada, aulas comunes de estudio	200	22	80

HOSPITALES, CONSULTAS MÉDICAS, CLÍNICAS

Salas comunes	200	22	80
Pasillos (horario diurno)	200	22	80
Pasillos (horario nocturno)	50	22	80
Salas de diagnóstico iluminación general	500	19	90
Salas de diagnóstico iluminación visita o tratamiento	1000	19	90
Sala operatoria, quirófano	1000	19	90
Farmacia, laboratorio, dentistas	500	19	90
Cuidados intensivos	1000	19	90
Salas de desinfección y esterilización	300	22	80

LUX: Nivel medio de iluminación horizontal. Generalmente calculado a una altura de unos 85 cm del suelo, siempre en zonas de trabajo, y a ras del mismo en zonas de circulación o de paso.

UGR: Índice unificado de deslumbramiento interno de la zona. Establece el deslumbramiento directo en cada aplicación según la distribución de la luminarias respecto a las características de la zona a iluminar y del punto de observación de los operadores.

R_a: Índice mínimo de rendimiento en color de las fuentes de luz.

PICTOGRAFIA

	Luminaria en que la protección contra los choques eléctricos está provista, aparte del aislamiento principal, por la conexión de las partes conductoras accesibles a tierra.		Auto-certificación C.E.
	Luminaria en que la protección contra los choques eléctricos no recae en el aislamiento principal, sino que comprende medidas de seguridad complementarias como el doble aislamiento.		Luminaria que necesita equipo pero no lo lleva incorporado.
	Luminaria en que la protección contra los choques eléctricos recae en la alimentación a muy baja tensión de seguridad (MBTS).		TRIAC Trailing edge
	Luminarias no adecuadas para cubrirse con material aislante térmico.		Luminaria de exterior para instalación bajo techo.
	Ángulo máximo de basculación de la luminaria.		Luminaria con las tapas finales no incorporadas.
	Ángulo máximo de giro horizontal de la luminaria.		Manguera de 1m HO7RN-F (3x1,5) incluida.
	Ángulo máximo de basculación en los dos ejes de una luminaria de sistema cardan.		Anodizado: Proceso electrolítico de pasivación cuyo objetivo es la protección contra la corrosión.
	Luminaria con cristal incorporado.		Clasificación Riesgo 0 (Grupo exento) según norma EN62471
	Acero Inoxidable.		Luminaria con fuente de luz blanco dinámico (2700-6500 K)
	Cuerpo de policarbonato.		Cuerpo de policarbonato reciclado.
	Cuerpo de aluminio.		Cuerpo de aluminio reciclado.
	Cataforesis. Proceso de pintado cuyo objetivo es la protección contra la corrosión.		Índice de deslumbramiento (Dimensiones: 4H8H Refl ctancias 70/50/20)
	El material ha superado con éxito la prueba del hilo incandescente a la temperatura indicada.		Tecnología Wellbeing
	Diámetro de empotramiento de suelo.		Difusor Metacrilato
	Diámetro de recorte de techo.		Active Cooling. Modelo que incorpora disipación activa.
	Medidas de recorte de techo rectangular.		Equipo DALI.
	Altura máxima del panel para adaptar el anclaje de la luminaria		

PICTOGRAFIA CO-CREATION

Regulación 1-10V	Longitudes
Regulación PUSH	Formatos
Regulación TRIAC	Acabados
Regulación DALI	Acabados en serigrafía
Bateria de emergencia	Integración de Sensores
Control Bluetooth	Instalación Trimless
LED para RETAIL (VW, carne, pescado, pan, fruta)	IP65
Otras distribuciones	Adaptación para Ambientes Salinos
Flujo	Difusor Opal
Temperatura de color	IK 10 con Difusor de PC
LED ámbar	Instalación Exterior
Índice de reproducción cromática	Tecnología Wellbeing
Blanco dinámico	

CÓDIGO IP

De acuerdo con la Norma EN 60598-1, las luminarias se clasifican en función de la protección derivada de sus elementos constructivos. La nomenclatura viene simbolizada por las letra IP seguidas de tres cifras, aunque se indiquen las dos primeras.



● 1ª cifra

Protección del material frente a la filtración de elementos sólidos extraños y polvo, así como de las persona respecto a la tensión de los componentes de la luminaria.

- 0 - No protegida.
- 1 - Protegida frente a cuerpos sólidos mayores de 50 mm.
- 2 - Protegida frente a cuerpos sólidos mayores de 12 mm.
- 3 - Protegida frente a cuerpos sólidos mayores de 2,50 mm.
- 4 - Protegida frente a cuerpos sólidos mayores de 1 mm.
- 5 - Protegida contra el polvo.
- 6 - Completa protección contra el polvo.

● 2ª cifra

Protección del material a la penetración de líquido.

- 0 - No protegida.
- 1 - Protegida a la caída vertical de gotas de agua.
- 2 - Protegida frente a la caída de gotas hasta un ángulo de 15° respecto a la vertical.
- 3 - Protegida frente la lluvia.
- 4 - Protegida contra la proyección de agua.
- 5 - Protegida al chorro de agua.
- 6 - Protegida a los golpes de mar.
- 7 - Protegida a la inmersión.
- 8 - Material sumergible.

CÓDIGO IK

Sistema de codificación para indicar el grado de protección proporcionado por una envolvente contra los impactos mecánicos nocivos.















IK	Energía de impacto (J)
IK00	0
IK01	0,15
IK02	0,2
IK03	0,35
IK04	0,5
IK05	0,7
IK06	1
IK07	2
IK08	5
IK09	10
IK10	20





Technical General Information



ÓPTICAS















Ópticas	Δ
 Superspot (SSP)	0° - 9°
 Spot (SP)	10° - 19°
 Medium Flood (MFL)	20° - 29°
 Flood (FL)	30° - 39°
 Wide Flood (WFL)	40° - 69°
 Very Wide Flood (VWFL)	>70°
 Elliptical	12° x 30°
 Street	-
 Direct / Indirect	-
 Opal	-
 Prismatic	-
 360°	-

TEMPERATURA DE COLOR

K	Color
5000 K	Cool White 
4000 K	Neutral White 
3000 K	Warm White 
2700 K	Very Warm White 
2700-6500 K	Tunable White 

ACABADOS

 BLACK: B	
 Black 01	RAL 9005 NEGRO
 Black 02	RAL 9011 NEGRO MATE
 Black 03	RAL 9011 NEGRO TEXTURIZADO
 Black 04	RAL 9011 NEGRO BRILLO
 Black 05	RAL 7021 TEXT. MATE
 Black 06	CATAFORESIS
 ANTHRACITE: A	
 Anthracite	ANTRACITA
 GREY: G	
 Grey 01	RAL 9006
 Grey 02	ANODIZADO PLATA MATE
 Grey 03	SW GRIS TEXTURIZADO
 INOX: I	
 Inox 01	ACERO INOXIDABLE AISI 303
 Inox 02	ACERO INOXIDABLE AISI 304
 CHROME: R	
 Chrome 01	CROMADO 1
 WHITE: W	
 White 01	RAL 9104 BLANCO TEXTURIZADO
 White 02	RAL 9010 BLANCO MATE
 White 03	RAL 9010 BLANCO TEXTURIZADO
 White 04	RAL 9010 BLANCO BRILLO
 White 05	RAL 9016 BLANCO TEXTURIZADO
 White 06	RAL 9016 BLANCO MATE

 YELLOW: Y	
 Yellow 01	RAL 1021 TEXTURIZADO
 CUPPER: C	
 Cupper 01	COBRE MATE
 WELLBEING: 3	
 4050-R90B	
 1505-Y10R	
 7024	
 4030-B50G	
 7001	
 BE SOCIAL: 4	
 4050-R90B	
 1050-B10G	
 7502-R	
 2070-Y80R	
 2011	
 MATERIALITY: 1	
 1505-Y10R	
 7024	
 3010-G	
 2010-Y20R	
 3013	

COLORES ESPECIALES

Colores distintos a los establecidos en la tarifa, se consideran **ejecuciones especiales**. Precio y plazo de entrega a consultar. Según su aplicación, pueden advertirse pequeñas diferencias entre los colores originales y los conseguidos en determinados productos.



Adscritos a ECOTIC Fundación para el Medio Ambiente, en aplicación de la Directiva Comunitaria 2002/96/CE RAEE'S, para el reciclaje de los residuos de aparatos eléctricos y electrónicos de iluminación. El coste de gestión ECORAEE de las luminarias queda asumido por Lamp. Por lo que respecta a las lámparas incluidas en algunas de nuestras luminarias, se les repercutirá la tasa ECORAEE que a su vez nos aplica el fabricante.

Serán de aplicación a los suministros efectuados por Lamp S.A.U. las condiciones de devolución de materiales de iluminación, que se indican a continuación:

- 1º Toda devolución que no se produzca por error del fabricante, necesita una autorización previa, por parte de la empresa.
- 2º No se aceptarán devoluciones de material especial, es decir, fuera de tarifa vigente.
- 3º Toda devolución hará siempre referencia a la factura y/o albarán, con que fue suministrado.
- 4º No se admitirá devolución en ningún caso de material alguno que tenga una antigüedad superior a 90 días, referidos a la fecha de la factura del suministro.
- 5º En caso de que se acepte expresamente la devolución de un material, este deberá estar en su embalaje original, en cajas completas, sin abrir y en buen estado de conservación, como si de un producto nuevo se tratara.
- 6º La devolución del material se efectuará a portes pagados, y por cuenta y riesgo del cliente.
- 7º El abono relativo a toda devolución autorizada conllevará una depreciación mínima del 15% del importe neto de la factura.

General Terms and Conditions of Sale



Todos los pedidos cursados implican la aceptación íntegra, por parte del comprador, de las presentes Condiciones Generales de Venta.

1. Precios

Se aplicarán las tarifas vigentes en la fecha de recepción del pedido con los descuentos acordados. Para artículos fuera de catálogo y ejecuciones especiales se tendrá que solicitar oferta explícita.

2. Confirmación del pedido.

El cliente tiene la obligación de revisar la confirmación del pedido cursado en un plazo de 72h. El Cliente será el único responsable de la precisión del pedido, incluso con respecto a la especificación, la configuración u otros requisitos de los Productos y Servicios, como también la funcionalidad, compatibilidad con los de sistemas control e interoperabilidad con otros productos no suministrados por LAMP, así como la adecuación para un uso en particular. El Cliente garantiza que la información proporcionada a LAMP es completa, precisa y verdadera, además, el Cliente reconoce que el incumplimiento en la presentación de información o instrucciones completas, precisas y verdaderas a LAMP puede perjudicar la capacidad de LAMP para cumplir con sus obligaciones o ejercer sus derechos en virtud de un Acuerdo.

3. Entregas

El lugar que se considera de entrega del material, por lo tanto de venta, es siempre nuestra fábrica o almacén, por lo que las mercancías viajan por cuenta y riesgo del comprador. Los riesgos relativos a la devolución de los productos correrán siempre a cargo del comprador. En caso de dificultades graves LAMP atenderá los pedidos en función de sus posibilidades.

4. Plazos de disponibilidad (franco fábrica)

Para orientar a nuestros clientes sobre la disponibilidad de producto en nuestro almacén, hemos clasificado nuestras referencias de la siguiente forma:

- Plazo de disponibilidad orientativo: **1 semana** (contados a partir de la formalización del pedido)
- Plazo de disponibilidad orientativo: **2 semanas** (contados a partir de la formalización del pedido)
- Plazo de disponibilidad orientativo: **a determinar por LAMP** (contados a partir de la formalización del pedido)

Los puntos azules ● están indicados antes del código de cada referencia.

Los plazos de entrega se deberán confirmar para cada pedido. Todos estos plazos pueden verse incrementados en un día debido a los procesos de expedición. **LAMP S.A.U. no incurrirá en ninguna responsabilidad ni penalización por el incumplimiento de los mismos.**

5. Transporte

Los portes serán siempre a cargo del comprador, salvo en los casos en que se pacte lo contrario.

El destinatario tiene la obligación de examinar la mercancía a su recepción, y hacer constar las incidencias, si las hubiere en el albarán de entrega o reclamar en un plazo máximo de 48 horas a su agencia de transportes si se envió a portes debidos o a Lamp si fue a portes pagados.

6. Anulación de pedidos

Todos los pedidos deben ser anulados por escrito. Si la anulación se produjese posteriormente a la expedición del pedido, se procederá a tratar como una devolución, cuyo procedimiento se explica en el punto 9. Los pedidos de ejecución especial no podrán ser anulados, si ya están en el proceso de producción.

7. Muestras

Todas las muestras de material deberán ser solicitadas bajo pedido y serán facturadas. Una vez devueltas serán abonadas íntegramente salvo en los casos que hayan sufrido desperfectos o modificaciones.

8. Ejecuciones especiales

Cualquier realización fuera de catálogo se ha de consultar de forma individualizada para conocer su viabilidad, precio y plazo de entrega.

9. Proyectos de iluminación

Ponemos a disposición de todos nuestros clientes, el servicio gratuito de nuestro Departamento Técnico de Proyectos, donde les podemos desarrollar un estudio de cálculo de alumbrado. Juntamente con el informe técnico será entregado el presupuesto y un plano para facilitarles la ejecución de la obra. Puede solicitar gratuitamente nuestro programa de cálculo de iluminación.

10. Servicio de devoluciones

LAMP S.A.U. aceptará devoluciones de todos los materiales que aparezcan en la lista de precios marcados con el símbolo ● (un solo punto azul).

Requisitos formales:

- El cliente debe haber formulado su pedido original **por escrito** (fax, e-mail, carta...).

- Debe haberse solicitado a **LAMP S.A.U.** un **número de autorización de devolución**.

- El material no debe haber sufrido **ningún tipo de desperfecto**.

Plazos:

- El plazo para solicitar el número de autorización de devolución será como máximo de 90 días naturales **contados a partir de la fecha de expedición de la mercancía**.

- El plazo para la devolución de la mercancía será como **máximo de 30 días naturales contados a partir de la fecha de recepción del número de autorización de devolución** (el cual será notificado por **LAMP S.A.U.** por escrito)

Condiciones:

- **LAMP S.A.U.** estará facultada a no aceptar ninguna devolución, cualquiera que fuese el motivo de ésta, en los siguientes casos:

- Incumplimiento de los requisitos formales y/o de plazos.
- Materiales fuera de catálogo.
- Ejecuciones especiales (electrificado, medidas, etc., distintos del estándar)
- Material pintado en color distinto al estándar.
- Materiales que aparezcan en la lista de precios marcados con los símbolos ●● (dos puntos azules) y/o ●●● (tres puntos azules).

- Todas las devoluciones de material que hayan sido debidamente autorizadas, se remitirán a **LAMP S.A.U.** con los portes pagados

Abonos:

LAMP S.A.U. procederá a abonar todas las devoluciones **(que cumplan todos y cada uno de los requisitos formales, de plazos y condiciones) por un importe del 85% del facturado originalmente. El 15% restante irá destinado a soportar los costes originados por las devoluciones (manipulación, embalaje, control de calidad...)**

Los abonos que se originen por causas diferentes a devoluciones (diferencias de precios, portes, errores, etc...) también estarán condicionados a los requisitos formales y de plazos, es decir el pedido original debe haberse formulado por escrito y ser reclamado como máximo **90 días naturales contados a partir de la fecha de expedición de la factura**.

Será imprescindible que el cliente esté al corriente de sus obligaciones de pago.

11. Calidad

Todos los productos suministrados por **LAMP S.A.U.**, disponen de la certificación CE, además de otras normativas y han sido sometidos a rigurosos controles de calidad que garantizan su correcto funcionamiento.

LAMP S.A., trabaja permanentemente para mejorar y adecuar sus fabricados. Por ello nos reservamos el derecho a modificar, suprimir o ampliar nuestros productos sin previo aviso, y sin que ello sea motivo de reclamaciones.

12. Garantía

LAMP S.A.U. garantiza el funcionamiento de todos y cada uno de sus productos contra cualquier defecto en los materiales y mano de obra empleados para su fabricación. La garantía comercial que ofrece **LAMP S.A.U.** es una extensión a la garantía legal obligatoria de 6 meses (Ley 23/2003) y se especifica de la siguiente forma: Se extiende el período de garantía a CINCO (5) años para productos LED que tengan el identificador "5 years warranty" en la ficha técnica y a un período de DOS (2) años para todos los demás productos estándar, a contar desde la fecha de entrega. Igualmente, el período de garantía de la reparación o reposición de productos Lamp se extiende a los 2 ó 5 años especificados en esta extensión de la Garantía legal. El alcance de la garantía de Lamp cubre todo el territorio nacional e internacional. Para hacer efectiva dicha garantía se deberá tramitar la correspondiente reclamación, por escrito, a nuestro departamento comercial. Nuestra garantía incluye la reparación, reposición, o cambio del producto y/o componentes sin cargo alguno para el cliente, excluyendo mano de obra, así como los gastos de transportación derivados del cumplimiento de garantía. Todas las especificaciones técnicas de la garantía de Lamp, así como los derechos del consumidor, quedan recogidas en el documento de Condiciones Generales de Garantía: <http://www.lamp.es/files/64880>.

13. Reserva de propiedad

LAMP S.A.U. se reserva el derecho de propiedad de todos los materiales que suministre, hasta que el comprador haya satisfecho el pago total de los mismos.

14. Jurisdicción

Para cualquier discrepancia o litigio que se derive de las citadas Condiciones Generales de Venta, ambas partes se someten a la competencia de los Juzgados y Tribunales de Terrassa (Barcelona), con expresa renuncia a su fuero propio.

NOTA: Este documento anula los anteriores. Datos válidos para pedidos cursados a partir del 01 de febrero de 2021.



Lamp (11/2024)

Edita:
Lamp S.A.U

Coordinación, Diseño Gráfico, Maquetación y Redacción:
Dept. Marketing Lamp



Lamp EUROPE

Lamp HEADQUARTERS

Córdoba, 16
08226 Terrassa (Spain)
T. +34 93 736 68 00
lamp@lamp.es

Lamp FRANCE

124 rue Réaumur
75002 Paris (France)
T. +33 (0) 5 62 13 91 14
france@lamp.es

Lamp AMERICA

Lamp CHILE

Exequiel Fernández,
2251 Macul, Santiago (Chile)
T. +56 2 2237 17 70
F. +56 2 2375 52 73
chile@lamp.cl

Lamp COLOMBIA

Calle 74B N° 69-15
Bogotá (Colombia)
T. +57 (1) 7430092
colombia@lamp.com.co

Lamp MEXICO

Granjas México
08400 México DF (México)
T. +52 55 5648 5350
mexico@lamp.es

Lamp MIDDLE EAST

Lamp MIDDLE EAST

Jumeirah Bay X2 - 3rd Floor
Cluster X - Jumeirah Lake Towers
P.O. BOX 126732
Dubai (UAE)
T. +971 4 437 5716
uae@lamp.es